

**ПРОСПЕКТ-КАТАЛОГ
КОЛОДОК ДИСКОВЫХ ТОРМОЗОВ
ДЛЯ ЛЕГКОВЫХ АВТОМОБИЛЕЙ
ЗАРУБЕЖНОГО ПРОИЗВОДСТВА**

Марка автомобиля	Годы выпуска автомобиля	Передние колодки			Задние колодки		
		Тип тормозной системы	№ по каталогу	Толщина изделия, мм	Тип тормозной системы	№ по каталогу	Толщина изделия, мм
ALFA ROMEO							
6 2,5 GTV, GTV 6	80-	ATE	TP.A 001	15,0			
33 1,7 4 WD	90-				GIR	TP.A 007	16,4
33 1,7 16 V (ABS)	89-				GIR	TP.A 007	16,4
33 1,7 16 V Quadrifoglio	89-90				GIR	TP.A 007	16,4
33 1,7i 16 V, Sport Wagon, Q.Verde (ABS)	90				GIR	TP.A 007	16,4
75 1,6i, ie	89-	ATE	TP.A 001	15,0			
75 1,6i, ie all models	85-89	ATE	TP.A 001	15,0			
75 1,8	85-89	ATE	TP.A 001	15,0			
75 1,8i	89	ATE	TP.A 001	15,0			
75 1,8i,e	85-89	ATE	TP.A 001	15,0			
75 1,8 (162.B1F, 162.B1H, 162.B1L)	09/88 – 02/92	ATE	TP.A-021	15,0			
75 1,8 Turbo (162.B1C, 162.B1D, 162.B1G)	09/86 – 02/92	ATE	TP.A-021	15,0			
75 1,8 Turbo i.e. (162.B1E)	02/86 – 01/90	ATE	TP.A-021	15,0			
75 2,0 T.S. (162.B4A) KAT	05/85 – 02/92	ATE	TP.A-021	15,0			
75 2,0 T.S. (162.4CB, 162.B4, 162.B4A)	01/87 – 02/92	ATE	TP.A-021	15,0			
75 Sedan 1,6 (162.B2B, 162.B2C) KAT	05/85 – 02/92	ATE	TP.A-001	15,0			
75 Sedan 1,8 (162.B1F, 162.B1H, 162.B1L)	09/88 – 02/92	ATE	TP.A-021	15,0			
75 Sedan 1,8 Turbo (162.B1C, 162.B1D, 162.B1G)	09/86 – 02/92	ATE	TP.A-021	15,0			
75 Sedan 1,8 Turbo i.e. (162.B1E)	02/86 – 01/90	ATE	TP.A-021	15,0			
75 Sedan 2,0 T.S. (162.B4A) KAT	05/85 – 02/92	ATE	TP.A-021	15,0			
75 Sedan 2,0 T.S. (162.4CB, 162.B4, 162.B4A)	01/87 – 02/92	ATE	TP.A-021	15,0			
155 2,5 V 6 (ABS)	94-				GIR	TP.A 007	16,4
155 2,0 D, TD	94-				GIR	TP.A 007	16,4
155 2,5 D, TD	94-				GIR	TP.A 007	16,4
164 2,0	87-89				GIR	TP.A 007	16,4
164 2,0i Twin Spark	87-89				GIR	TP.A 007	16,4
164 2,0 Turbo Intercooler Super	87-89				GIR	TP.A 007	16,4
164 2,0 Turbo Intercooler Super	89-				GIR	TP.A 007	16,4
164 3,0i 24 V Super (ABS)	95-				GIR	TP.A 007	16,4
164 3,0i Comfort (ABS)	87-				GIR	TP.A 007	16,4
164 3,0i Quadrifoglio Verde (ABS)	87-				GIR	TP.A 007	16,4
164 3,0i V 6 (ABS)	89-				GIR	TP.A 007	16,4
164 2,5 D, TD (ABS)	87-				GIR	TP.A 007	16,4
164 Sedan 2,0	06/87 – 09/98				GIR	TP.A-007	16,4
164 Sedan 2,0 T.S. (164.A2C, 164.A2L, 164.A2H, 164.H3)	06/87 – 09/98				GIR	TP.A-007	16,4
164 Sedan 2,0 Turbo	10/87 – 09/98				GIR	TP.A-007	16,4

Марка автомобиля	Годы выпуска автомобиля	Передние колодки			Задние колодки		
		Тип тормозной системы	№ по каталогу	Толщина изделия, мм	Тип тормозной системы	№ по каталогу	Толщина изделия, мм
AUDI							
50 1,1 L, LS, GL, GLS	74-78	ATE	TP.A 001	15,0			
50 1,3 LS, GLS	74-78	ATE	TP.A 001	15,0			
60 1,3 L Variant N	66-72	ATE	TP.A 001	15,0			
60 1,5 L Variant N	66-72	ATE	TP.A 001	15,0			
75 1,7 L Variant N	66-72	ATE	TP.A 001	15,0			
80 1,3 C, CL, CC, GL	72-81	ATE	TP.A 001	15,0			
80 1,3 L, LS	72-76	ATE	TP.A 001	15,0			
80 1,5 S, LS	72-76	ATE	TP.A 001	15,0			
80 1,6 S, LS	72-76	ATE	TP.A 001	15,0			
80 1,6 C, CD	86-89	GIR	TP.A 003	16,5			
80 1,6 C, CD (ABS)	91-92				GIR	TP.A 007	16,4
80 1,6 CC, CL, Formel E, ind. autom	78-79	ATE	TP.A 001	15,0			
80 1,6 CD, GL, Formel E, ind. autom	78-80	ATE	TP.A 001	15,0			
80 1,6 GLS, ind. autom	76-78	ATE	TP.A 001	15,0			
80 1,6 GT, GTE	72-78	ATE	TP.A 001	15,0			
80 1,6i GLE, GTE (ABS)	93-	GIR	TP.A 003	19,4	GIR	TP.A 007	16,4
80 1,6 L, GL	76-81	ATE	TP.A 001	15,0			
80 1,6 S, LS, GLS	76-78	ATE	TP.A 001	15,0			
80 1,6 S, LS, GLS (ABS)	78-79	ATE	TP.A 001	18,5			
80 1,6 S, LS, GLS, CL, GL, CC, CD, SC	78-79	ATE	TP.A 001	15,0			
80 1,6 Turbo	88-90	GIR	TP.A 003	16,5			
80 1,8 GL Coupe, GT (ABS)	86-89	GIR	TP.A 003	19,4			
80 1,8i CC, E, GLE, GTE (ABS)	86-91				GIR	TP.A 007	16,4
80 1,8i CL, GLE (ABS)	86-91				GIR	TP.A 007	16,4
80 1,8i S	86-88	GIR	TP.A 003	16,5			
80 1,9i (ABS)	86-88				GIR	TP.A 007	16,4
80 1,9i CD, CD5 S, E (ABS)	86-88				GIR	TP.A 007	16,4
80 1,9i E (ABS)	86-88	GIR	TP.A 003	16,5	GIR	TP.A 007	16,4
80 1,9 D	89-91	GIR	TP.A 003	16,5			
80 1,9i TDI (ABS)	91-	GIR	TP.A 003	19,4			
80 1,9i TDI Avant (ABS)	91-	GIR	TP.A 003	19,4	GIR	TP.A 007	16,4
80 1,9 TD Avant (ABS)	91-	GIR	TP.A 003	19,4	GIR	TP.A 007	16,4
80 1,9 TD (ABS)	91-	GIR	TP.A 003	19,4			
80 Quattro 2,2 all models (ABS)	94-				GIR	TP.A 007	16,4
80 Quattro 2,2i RSZ (ABS)	94-				GIR	TP.A 007	16,4
80 Quattro 2,3i E (ABS)	91-	GIR	TP.A 003	16,5	GIR	TP.A 007	16,4
80 Quattro 2,6i E (ABS)	91-	GIR	TP.A 003	16,5	GIR	TP.A 007	16,4
80 Quattro 2,8i E (ABS)	91-	GIR	TP.A 003	16,5	GIR	TP.A 007	16,4
80 Avant (8C, B4) 1,6 E	06/93 – 01/96	GIR	TP.A-003	19,4	GIR	TP.A-007	16,4
80 Avant (8C, B4) 1,9 TD / TDI	09/91 – 01/96	GIR	TP.A-003	19,4	GIR	TP.A-007	16,4
80 Avant (8C, B4) 2,0	07/92 – 01/96	GIR	TP.A-003	19,4	GIR	TP.A-007	16,4
80 Avant (8C, B4) 2,0 E	07/92 – 01/96	GIR	TP.A-003	19,4	GIR	TP.A-007	16,4

Марка автомобиля	Годы выпуска автомобиля	Передние колодки			Задние колодки		
		Тип тормозной системы	№ по каталогу	Толщина изделия, мм	Тип тормозной системы	№ по каталогу	Толщина изделия, мм
AUDI							
80 Avant (8C, B4) 2,0 E 16V	02/93 – 01/96	GIR	TP.A-003	19,4	GIR	TP.A-007	16,4
80 Avant (8C, B4) 2,0 E 16V Quattro	12/92 – 07/95	GIR	TP.A-003	19,4	GIR	TP.A-007	16,4
80 Avant (8C, B4) 2,3 E	07/92 – 01/96	GIR	TP.A-003	19,4	GIR	TP.A-007	16,4
80 Avant (8C, B4) 2,3 E Quattro	09/91 – 11/94	GIR	TP.A-003	19,4	GIR	TP.A-007	16,4
80 Avant (8C, B4) 2,6	07/92 – 01/96	GIR	TP.A-003	19,4	GIR	TP.A-007	16,4
80 Avant (8C, B4) 2,6 Quattro	07/92 – 07/95				GIR	TP.A-007	16,4
80 Avant (8C, B4) 2,8	09/91 – 01/96				GIR	TP.A-007	16,4
80 Avant (8C, B4) 2,8 Quattro	08/92 – 07/95				GIR	TP.A-007	16,4
80 Avant (8C, B4) S2 Quattro	02/93 – 07/95				GIR	TP.A-007	16,4
80 Sedan (89, 89Q, 8A, B3) 1,6	09/86 – 10/91	GIR	TP.A-003	19,4	GIR	TP.A-007	16,4
80 Sedan (89, 89Q, 8A, B3) 1,6 D / TD	09/86 – 08/91	GIR	TP.A-003	19,4	GIR	TP.A-007	16,4
80 Sedan (89, 89Q, 8A, B3) 1,8	09/86 – 01/90	GIR	TP.A-003	19,4	GIR	TP.A-007	16,4
80 Sedan (89, 89Q, 8A, B3) 1,8 E	06/86 – 08/91	GIR	TP.A-003	19,4	GIR	TP.A-007	16,4
80 Sedan (89, 89Q, 8A, B3) 1,8 E Quattro	09/86 – 08/91	GIR	TP.A-003	19,4	GIR	TP.A-007	16,4
80 Sedan (89, 89Q, 8A, B3) 1,8 S	09/86 – 10/91	GIR	TP.A-003	19,4	GIR	TP.A-007	16,4
80 Sedan (89, 89Q, 8A, B3) 1,8 S Quattro	09/86 – 09/91	GIR	TP.A-003	19,4	GIR	TP.A-007	16,4
80 Sedan (89, 89Q, 8A, B3) 1,9 D	08/89 – 08/91	GIR	TP.A-003	19,4	GIR	TP.A-007	16,4
80 Sedan (89, 89Q, 8A, B3) 2,0	10/90 – 08/91	GIR	TP.A-003	19,4	GIR	TP.A-007	16,4
80 Sedan (89, 89Q, 8A, B3) 2,0 E 16V	03/90 – 09/91	GIR	TP.A-003	19,4	GIR	TP.A-007	16,4
80 Sedan (89, 89Q, 8A, B3) 2,0 E 16V Quattro	03/90 – 08/91	GIR	TP.A-003	19,4	GIR	TP.A-007	16,4
80 Sedan (89, 89Q, 8A, B3) 2,0 E Quattro	08/88 – 08/91	GIR	TP.A-003	19,4	GIR	TP.A-007	16,4
80 Sedan (8C, B4) 1,6	09/91 – 12/94	GIR	TP.A-003	19,4	GIR	TP.A-007	16,4
80 Sedan (8C, B4) 1,6 E	06/93 – 12/94	GIR	TP.A-003	19,4	GIR	TP.A-007	16,4
80 Sedan (8C, B4) 1,9 TD / TDI	09/91 – 12/94	GIR	TP.A-003	19,4	GIR	TP.A-007	16,4
80 Sedan (8C, B4) 2,0	09/91 – 12/94	GIR	TP.A-003	19,4	GIR	TP.A-007	16,4
80 Sedan (8C, B4) 2,0 E	09/91 – 12/94	GIR	TP.A-003	19,4	GIR	TP.A-007	16,4
80 Sedan (8C, B4) 2,0 E 16V	08/92 – 12/94	GIR	TP.A-003	19,4	GIR	TP.A-007	16,4
80 Sedan (8C, B4) 2,0 E 16V Quattro	04/92 – 12/94	GIR	TP.A-003	19,4	GIR	TP.A-007	16,4

Марка автомобиля	Годы выпуска автомобиля	Передние колодки			Задние колодки		
		Тип тормозной системы	№ по каталогу	Толщина изделия, мм	Тип тормозной системы	№ по каталогу	Толщина изделия, мм
AUDI							
80 Sedan (8C, B4) 2,0 E Quattro	09/91 – 12/94	GIR	TP.A-003	19,4	GIR	TP.A-007	16,4
80 Sedan (8C, B4) 2,3 E	09/91 – 12/94	GIR	TP.A-003	19,4	GIR	TP.A-007	16,4
80 Sedan (8C, B4) 2,3 E Quattro	09/91 – 12/94	GIR	TP.A-003	19,4	GIR	TP.A-007	16,4
80 Sedan (8C, B4) 2,6	07/92 – 12/94	GIR	TP.A-003	19,4	GIR	TP.A-007	16,4
80 Sedan (8C, B4) 2,6 Quattro	06/92 – 12/94				GIR	TP.A-007	16,4
80 Sedan (8C, B4) 2,8	09/91 – 12/94				GIR	TP.A-007	16,4
80 Sedan (8C, B4) 2,8 Quattro	09/91 – 12/94				GIR	TP.A-007	16,4
80 Sedan (8C, B4) S2 Quattro	02/93 – 12/94				GIR	TP.A-007	16,4
80/90 1,3 L	78-81	ATE	TP.A 001	15,0			
80/90 1,4 C, CC	86-91	GIR	TP.A 003	19,4			
80/90 1,6 CD, CL, GL, GLE, GLS	86-91	GIR	TP.A 003	19,4			
80/90 1,6 L, GL	78-84	ATE	TP.A 001	15,0			
80/90 1,8i	86-91	GIR	TP.A 003	19,4			
80/90 1,8i E (ABS)	86-91	GIR	TP.A 003	19,4	GIR	TP.A 007	16,4
80/90 1,8i S (ABS)	86-91	GIR	TP.A 003	19,4			
80/90 2,0 E (ABS)	92-	GIR	TP.A 003	19,4	GIR	TP.A 007	16,4
80/90 2,0 E 16 V (ABS)	86-91	GIR	TP.A 003	19,4	GIR	TP.A 007	16,4
80/90 2,0 E 20 V (ABS)	86-91	GIR	TP.A 003	19,4	GIR	TP.A 007	16,4
80/90 2,0i 20 V (ABS)	86-91	GIR	TP.A 003	19,4	GIR	TP.A 007	16,4
80/90 2,2i (ABS)	78-87	GIR	TP.A 003	19,4	GIR	TP.A 007	16,4
80/90 2,2i E (ABS)	86-91	GIR	TP.A 003	19,4	GIR	TP.A 007	16,4
80/90 2,3i 20 V, 2,3 E (ABS)	87-88	GIR	TP.A 003	19,4	GIR	TP.A 007	16,4
80/90 2,3i 20 V, 2,3 E (ABS)	88-91				GIR	TP.A 007	16,4
80/90 2,3i E, 2, - 16 V (ABS)	87-88	GIR	TP.A 003	19,4	GIR	TP.A 007	16,4
80/90 1,6 D Turbo	86-91	GIR	TP.A 003	19,4			
80/90 1,6 D, TD	86-91	GIR	TP.A 003	19,4			
80/90 1,9 D	86-91	GIR	TP.A 003	19,4			
80/90 1,9i TD, TDi	86-91	GIR	TP.A 003	19,4	GIR	TP.A 007	16,4
80/90 2,0i (ABS)	86-88	GIR	TP.A 003	16,5	GIR	TP.A 007	16,4
80/90 2,0i (ABS)	83-87	GIR	TP.A 003	19,4	GIR	TP.A 007	16,4
80/90 2,0i Quattro (ABS)	86-88	GIR	TP.A 003	16,5	GIR	TP.A 007	16,4
80/90 2,0i Quattro (ABS)	88-91				GIR	TP.A 007	16,4
80/90 2,0i Quattro, CC (ABS)	83-87	GIR	TP.A 003	19,4	GIR	TP.A 007	16,4
80/90 2,2i (ABS)	83-87	GIR	TP.A 003	19,4	GIR	TP.A 007	16,4
80/90 2,2i Quattro (ABS)	83-87	GIR	TP.A 003	19,4	GIR	TP.A 007	16,4
80/90 2,2i Quattro E (ABS)	83-87	GIR	TP.A 003	19,4	GIR	TP.A 007	16,4
80/90 2,3i (ABS)	86-88	GIR	TP.A 003	16,5	GIR	TP.A 007	16,4
80/90 2,3i (ABS)	88-91				GIR	TP.A 007	16,4

Марка автомобиля	Годы выпуска автомобиля	Передние колодки			Задние колодки		
		Тип тормозной системы	№ по каталогу	Толщина изделия, мм	Тип тормозной системы	№ по каталогу	Толщина изделия, мм
AUDI							
80/90 2,3i Quattro (ABS)	83-87	GIR	TP.A 003	19,4	GIR	TP.A 007	16,4
80/90 2,3i Quattro (ABS)	86-88	GIR	TP.A 003	16,5	GIR	TP.A 007	16,4
80/90 2,3i Quattro 20 V (ABS)	88-91				GIR	TP.A 007	16,4
80/90 2,3i 20 V (ABS)	86-88	GIR	TP.A 003	16,5	GIR	TP.A 007	16,4
90 2,0 (ABS)	90-	GIR	TP.A 003	19,4	GIR	TP.A 007	16,4
90 2,0 S ind. autom (ABS)	84-87	GIR	TP.A 003	16,5	GIR	TP.A 007	16,4
90 2,2i E (ABS)	84-87	GIR	TP.A 003	16,5	GIR	TP.A 007	16,4
90 2,2i S ind. autom (ABS)	84-87	GIR	TP.A 003	16,5	GIR	TP.A 007	16,4
90 2,3 E (ABS)	90-	GIR	TP.A 003	19,4	GIR	TP.A 007	16,4
Super 90	69-	ATE	TP.A 001	15,0			
90 Sedan (89, 89Q, 8A, B3) 1,6 TD	04/87 – 09/91	GIR	TP.A-003	19,4	GIR	TP.A-007	16,4
90 Sedan (89, 89Q, 8A, B3) 2,0	07/88 – 09/91	GIR	TP.A-003	19,4	GIR	TP.A-007	16,4
90 Sedan (89, 89Q, 8A, B3) 2,0 20 V	08/89 – 07/91	GIR	TP.A-003	19,4	GIR	TP.A-007	16,4
90 Sedan (89, 89Q, 8A, B3) 2,0 20 V Quattro	08/88 – 09/91	GIR	TP.A-003	19,4	GIR	TP.A-007	16,4
90 Sedan (89, 89Q, 8A, B3) 2,2 E	04/87 – 07/91	GIR	TP.A-003	19,4	GIR	TP.A-007	16,4
90 Sedan (89, 89Q, 8A, B3) 2,2 E Quattro	04/87 – 09/91	GIR	TP.A-003	19,4	GIR	TP.A-007	16,4
90 Sedan (89, 89Q, 8A, B3) 2,3 E	04/87 – 09/91	GIR	TP.A-003	19,4	GIR	TP.A-007	16,4
90 Sedan (89, 89Q, 8A, B3) 2,3 E 20V	08/88 – 07/91				GIR	TP.A-007	16,4
90 Sedan (89, 89Q, 8A, B3) 2,3 E 20V Quattro	06/88 – 09/91				GIR	TP.A-007	16,4
90 Sedan (89, 89Q, 8A, B3) 2,3 E Quattro	04/87 – 09/91	GIR	TP.A-003	19,4	GIR	TP.A-007	16,4
100 2,0 CC, CS, CD Turbo	82-	GIR	TP.A 003	16,5	GIR	TP.A 007	16,4
100 2,1 Turbo CS	86-9/90	ATE	TP.A 061	17,5	GIR	TP.A 007	16,4
100 2,2 CC, CS, CD, Avant (ABS)	82-90				GIR	TP.A 007	16,4
100 2,0 D	82-	GIR	TP.A 003	16,5	GIR	TP.A 007	16,4
100 2,0 D	90-				GIR	TP.A 007	16,4
100 2,0 TD (ABS)	82-	GIR	TP.A 003	16,5	GIR	TP.A 007	16,4
100 2,4 D (ABS)	82-	GIR	TP.A 003	16,5	GIR	TP.A 007	16,4
100 2,5 D ind. autom. (ABS)	82-	GIR	TP.A 003	16,5	GIR	TP.A 007	16,4
100 2,5 TDI, TDI Avant (ABS)	82-90				GIR	TP.A 007	16,4
100 (44, 44Q, C3) 1,8 KAT	03/85 – 11/90	GIR	TP.A-003	19,4			
100 (44, 44Q, C3) 1,8 Quattro KAT	08/85 – 11/90	GIR	TP.A-003	19,4			
100 (44, 44Q, C3) 2,3 E	10/86 – 11/90	GIR ATE	TP.A-003 TP.A-019	19,4 19,5	GIR	TP.A-007	16,4
100 (44, 44Q, C3) 2,3 Quattro	01/90 – 11/90	ATE	TP.A-019	19,5	GIR	TP.A-007	16,4
100 (4A, C4) 2,0	12/90 – 06/94	ATE	TP.A-019	19,5	GIR	TP.A-007	16,4

Марка автомобиля	Годы выпуска автомобиля	Передние колодки			Задние колодки		
		Тип тормозной системы	№ по каталогу	Толщина изделия, мм	Тип тормозной системы	№ по каталогу	Толщина изделия, мм
AUDI							
100 Avant (44, 44Q, C3) 2,3	03/90 – 11/90	ATE	TP.A-019	19,5	GIR	TP.A-007	16,4
100 Avant (44, 44Q, C3) 2,3 Quattro	01/90 – 11/90	ATE	TP.A-019	19,5	GIR	TP.A-007	16,4
100 Avant (44, 44Q, C3) 2,4 D	08/89 – 11/90				GIR	TP.A-007	16,4
100 Avant (44, 44Q, C3) 2,5 TDI	01/90 – 11/90				GIR	TP.A-007	16,4
100 Avant (4A, C4) 2,0 E	09/91 – 06/94	ATE	TP.A-019	19,5	GIR	TP.A-007	16,4
100 Avant (4A, C4) 2,0 E 16V	07/92 – 06/94	ATE	TP.A-019	19,5	GIR	TP.A-007	16,4
100 Avant (4A, C4) 2,4 D	12/90 – 06/94	ATE	TP.A-019	19,5	GIR	TP.A-007	16,4
100 Avant (4A, C4) 2,5 TDI	12/90 – 06/94	ATE	TP.A-019	19,5	GIR	TP.A-007	16,4
100 Avant (4A, C4) 2,6	03/92 – 06/94	ATE	TP.A-019	19,5	GIR	TP.A-007	16,4
100 Avant (4A, C4) 2,6 Quattro	07/92 – 06/94	ATE	TP.A-019	19,5	GIR	TP.A-007	16,4
100 Avant (4A, C4) S4 Turbo Quattro	09/91 – 06/94				GIR	TP.A-007	16,4
100 Avant (4A, C4) S4 V8 Quattro	10/92 – 06/94				GIR	TP.A-007	16,4
100 Avant Quattro 1,8 wheels 14"	85-90	GIR	TP.A 003	19,4			
100 Avant Quattro 2,0 E	90-	ATE	TP.A-019	19,5	GIR	TP.A 007	16,4
100 Avant Quattro 2.0i Sedan	84-86	GIR	TP.A 003	19,4			
100 Avant Quattro 2,2 (ABS)	84-				GIR	TP.A 007	16,4
100 Avant Quattro 2,2	84-	GIR	TP.A 003	16,5	GIR	TP.A 007	16,4
100 Avant Quattro 2,2 Wheels 15"	85-90	GIR	TP.A 003	19,4			
100 Avant Quattro 2,2 CS (ABS)	84-	GIR	TP.A 003	16,5	GIR	TP.A 007	16,4
100 Avant Quattro 2,2i CS (ABS)	84-	GIR	TP.A 003	16,5	GIR	TP.A 007	16,4
100 Avant Quattro 2,2 C4 (ABS)	90-				GIR	TP.A 007	16,4
100 Avant Quattro 2,3 CS (ABS)	84-	GIR	TP.A 003	16,5	GIR	TP.A 007	16,4
100 Avant Quattro 2,3 T (ABS)	90-	ATE	TP.A-019	19,5	GIR	TP.A 007	16,4
100 Avant Quattro 2,3i CS (ABS)	84-	GIR	TP.A 003	16,5	GIR	TP.A 007	16,4
100 Avant Quattro 2,3i Heavy Triper	88-91	GIR	TP.A 003	19,4			
100 Avant Quattro 2,3i Turbo (ABS)	84-	GIR	TP.A 003	16,5	GIR	TP.A 007	16,4
100 Avant Quattro 2,3i CD, CS	88-91	GIR	TP.A 003	19,4			
100 Avant TDi Diesel	90-91	ATE	TP.A 061	17,5	GIR	TP.A 007	16,4
100 Avant Quattro 2,6 E (ABS)	90-				GIR	TP.A 007	16,4
100 Avant Quattro 2,8i (ABS)	90-	ATE	TP.A-019	19,5	GIR	TP.A 007	16,4
100 Sedan (4A, C4) 2,0	12/90 – 06/94	ATE	TP.A-019	19,5	GIR	TP.A-007	16,4
100 Sedan (4A, C4) 2,0 E	12/90 – 06/94	ATE	TP.A-019	19,5	GIR	TP.A-007	16,4
100 Sedan (4A, C4) 2,0 E 16V	01/92 – 06/94	ATE	TP.A-019	19,5	GIR	TP.A-007	16,4

Марка автомобиля	Годы выпуска автомобиля	Передние колодки			Задние колодки		
		Тип тормозной системы	№ по каталогу	Толщина изделия, мм	Тип тормозной системы	№ по каталогу	Толщина изделия, мм
AUDI							
100 Sedan (4A, C4) 2,0 E Quattro	12/90 – 07/92	ATE	TP.A-019	19,5	GIR	TP.A-007	16,4
100 Sedan (4A, C4) 2,3 E	12/90 – 06/94	ATE	TP.A-019	19,5	GIR	TP.A-007	16,4
100 Sedan (4A, C4) 2,3 E Quattro	12/90 – 06/94	ATE	TP.A-019	19,5	GIR	TP.A-007	16,4
100 Sedan (4A, C4) 2,4 D	12/90 – 06/94	ATE	TP.A-019	19,5	GIR	TP.A-007	16,4
100 Sedan (4A, C4) 2,5 TDI	12/90 – 06/94	ATE	TP.A-019	19,5	GIR	TP.A-007	16,4
100 Sedan (4A, C4) 2,6	03/92 – 06/94	ATE	TP.A-019	19,5	GIR	TP.A-007	16,4
100 Sedan (4A, C4) 2,6 Quattro	04/92 – 06/94	ATE	TP.A-019	19,5	GIR	TP.A-007	16,4
100 Sedan (4A, C4) 2,8 E	12/90 – 06/94	ATE	TP.A-019	19,5	GIR	TP.A-007	16,4
100 Sedan (4A, C4) 2,8 E Quattro	12/90 – 06/94	ATE	TP.A-019	19,5	GIR	TP.A-007	16,4
100 Sedan (4A, C4) S4 Turbo Quattro	08/91 – 06/94				GIR	TP.A-007	16,4
200 Sedan (44, 44Q) 2,2 20V Turbo Quattro	03/89 – 12/90				GIR	TP.A-007	16,4
200 Sedan (44, 44Q) 2,2 Turbo	08/85 – 09/91	GIR	TP.A-003	19,4	GIR	TP.A-007	16,4
200 Sedan (44, 44Q) 2,2 Turbo Quattro	01/85 – 12/91				GIR	TP.A-007	16,4
200 Sedan (44, 44Q) 2,3	11/86 – 09/91				GIR	TP.A-007	16,4
200 Turbo	91-	ATE	TP.A 061	17,5	GIR	TP.A 007	16,4
200 Quattro/Sedan/Station Wagon	89-90	ATE	TP.A 061	17,5			
200 2,0 Avant (ABS)	83-90				GIR	TP.A 007	16,4
200 2,1 Turbo (ABS)	83-90	GIR	TP.A 003	19,4	GIR	TP.A 007	16,4
200 2,2i (ABS)	83-	GIR	TP.A 003	16,5	GIR	TP.A 007	16,4
200 2,2i 5E, 5T (ABS)	80-82	GIR	TP.A 003	19,4			
200 2,2i Turbo Avant, Turbo, Avant (ABS)	83-90	GIR	TP.A 003	19,4	GIR	TP.A 007	16,4
200 2,3i (ABS)	83-				GIR	TP.A 007	16,4
200 2,3 Avant (ABS)	83-90				GIR	TP.A 007	16,4
200 2,3i ind. autom (ABS)	83-				GIR	TP.A 007	16,4
200 2,3i Turbo (ABS)	79-	GIR	TP.A 003	16,5	GIR	TP.A 007	16,4
200 2,3i Turbo ind. autom (ABS)	79-83	GIR	TP.A 003	16,5	GIR	TP.A 007	16,4
200 2,3 ind. autom (ABS)	83-	GIR	TP.A 003	16,5	GIR	TP.A 007	16,4
200 2,0 TD (ABS)	83-	GIR	TP.A 003	16,5	GIR	TP.A 007	16,4
200 Quattro 2,1i Turbo, Avant (ABS)	86-	GIR	TP.A 003	19,4	GIR	TP.A 007	16,4
200 Quattro 2,2i Turbo, Avant (ABS)	86-	GIR	TP.A 003	19,4	GIR	TP.A 007	16,4
200 Quattro 2,3i Avant (ABS)	86-				GIR	TP.A 007	16,4
200 Quattro 2,8i E (ABS)	86-				GIR	TP.A 007	16,4

Марка автомобиля	Годы выпуска автомобиля	Передние колодки			Задние колодки		
		Тип тормозной системы	№ по каталогу	Толщина изделия, мм	Тип тормозной системы	№ по каталогу	Толщина изделия, мм
AUDI							
200 2,2i Turbo (ABS)	82-86	GIR	TP.A 003	19,4			
200 2,2i Turbo ind. autom (ABS)	83-	GIR	TP.A 003	16,5	GIR	TP.A 007	16,4
200 2,3i Turbo (ABS)	83-	GIR	TP.A 003	16,5	GIR	TP.A 007	16,4
200 Avant Quattro 2,2i (ABS)	85-86	GIR	TP.A 003	19,4	GIR	TP.A 007	16,4
200 Avant Quattro 2,3i (ABS)	85-86	GIR	TP.A 003	19,4	GIR	TP.A 007	16,4
200 Avant Quattro 2,3i 16V (ABS)	85-86	GIR	TP.A 003	19,4	GIR	TP.A 007	16,4
500 (44, 44Q, C3) 1,8 Quattro	10/84 – 07/90	GIR	TP.A-003	19,4	GIR	TP.A-007	16,4
500 (44, 44Q, C3) 1,8 Quattro KAT	08/85 – 11/90	GIR	TP.A-003	19,4	GIR	TP.A-007	16,4
500 (44, 44Q, C3) 2,0 D Turbo	08/82 – 11/90	GIR	TP.A-003	19,4	GIR	TP.A-007	16,4
500 (44, 44Q, C3) 2,0 KAT	01/88 – 11/90	GIR	TP.A-003	19,4	GIR	TP.A-007	16,4
500 (44, 44Q, C3) 2,2 E Turbo Quattro	08/86 – 11/90				GIR	TP.A-007	16,4
500 (44, 44Q, C3) 2,2 Quattro KAT	06/89 – 11/90				GIR	TP.A-007	16,4
500 (44, 44Q, C3) 2,3 E	10/86 – 11/90	ATE	TP.A-019	19,5	GIR	TP.A-007	16,4
500 (44, 44Q, C3) 2,3 Quattro	01/90 – 11/90	ATE	TP.A-019	19,5	GIR	TP.A-007	16,4
500 (44, 44Q, C3) 2,4 D	08/89 – 07/91	GIR	TP.A-003	19,4	GIR	TP.A-007	16,4
500 (44, 44Q, C3) 2,5 TDI	01/90 – 07/91				GIR	TP.A-007	16,4
A1 (8X1) 1,2 TFSI	05/10 –	ATE	TP.A-065	19,8			
A1 (8X1) 1,4 TFSI	05/10 –	ATE	TP.A-065	19,8			
A1 (8X1) 1,6 TDI	05/10 –	ATE	TP.A-065	19,8			
A1 (8X1) 2,0 TDI	09/11 –	ATE	TP.A-065	19,8			
A1 (8X1) 2,0 TFSI Quattro	03/12 –	ATE	TP.A-065	19,8			
A1 Sportback (8XA) 1,2 TFSI	01/12 –	ATE	TP.A-065	19,8			
A1 Sportback (8XA) 1,4 TFSI	11/11 –	ATE	TP.A-065	19,8			
A1 Sportback (8XA) 1,6 TDI	11/11 –	ATE	TP.A-065	19,8			
A1 Sportback (8XA) 2,0 TDI	09/11 –	ATE	TP.A-065	19,8			
A2 (870) 1,4 PR TOU, T1Q,T60, T94	0200-0805	ATE	TP.A-092	19,8			
A2 (870) 1,4 PR TDI, T1Q,T60, T94	0200-0805	ATE	TP.A-092	19,8			
A2 (870) 1,6 FSI TOU, T1Q,T60, T94	0502-0805	ATE	TP.A-092	19,8			
A3 1,8 4 cyl. 20v	96-	ATE	TP.A 065	19,8	GIR	TP.A 014	15,0
A3 1,9 TDI 4 cyl. 8v	96-	ATE	TP.A 065	19,8	GIR	TP.A 014	15,0
A3 TT 1,6	97-				GIR	TP.A 014	17,4
A3 TT 1,8i (ABS)	97-				GIR	TP.A 014	17,4
A3 TT 1,8i 20V (ABS)	97-	ATE	TP.A 019	19,5	GIR	TP.A 014	17,4
A3 TT 1,9 TDI (ABS)	97-				GIR	TP.A 014	17,4
A3 (8L1) 1,6 -06/99	09/96-	ATE	TP.A-092	19,8			
A3 (8L1) 1,8 -03/99	09/96-	ATE	TP.A-092	19,8			
A3 (8L1) 1,8 Quattro -03/99, PR 1LQ, 1LS	08/98-	ATE	TP.A-092	19,8			

Марка автомобиля	Годы выпуска автомобиля	Передние колодки			Задние колодки		
		Тип тормозной системы	№ по каталогу	Толщина изделия, мм	Тип тормозной системы	№ по каталогу	Толщина изделия, мм
AUDI							
A3 (8L1) 1,9 TDI -04/98, PR 1LQ, 1LS	09/96-	ATE	TP.A-092	19,8			
A3 (8L1) 1,6 -06/99	09/96-	ATE	TP.A-092	19,8			
A3 (8L1) 1,6 -08/00, PR 1LQ	09/96-	ATE	TP.A-092	19,8			
A3 (8L1) 1,8 -03/99	09/96-	ATE	TP.A-092	19,8			
A3 (8L1) 1,8 Quattro -03/99, PR 1LQ, 1LS	08/98-	ATE	TP.A-092	19,8			
A3 (8L1) 1,9 TDI -04/98, PR 1LQ, 1LS	09/96-	ATE	TP.A-092	19,8			
A3 (8L1) 1,6 07/99-	09/96-	ATE	TP.A-092	19,8			
A3 (8L1) 1,6 09/00-, PR 1LS, 1ZP	09/96-	ATE	TP.A-092	19,8			
A3 (8L1) 1,6 PR 1LQ, 1ZP	09/96-	ATE	TP.A-092	19,8			
A3 (8L1) 1,8 04/99-, PR 1LQ, 1ZP	09/96-	ATE	TP.A-092	19,8			
A3 (8L1) 1,8 Quattro 04/99-, PR 1LQ, 1ZP	08/98	ATE	TP.A-092	19,8			
A3 (8L1) 1,9 TDI 05/98-, PR 1LQ, 1ZP	09/96-	ATE	TP.A-092	19,8			
A3 (8L1) 1,9 TDI PR 1LE	09/96-	ATE	TP.A-092	19,8			
A3 (8L1) 1,9 TDI PR 1LQ, 1ZP	09/96-	ATE	TP.A-092	19,8			
A3 (8P1) 1,4 TFSI PR 1ZM	09/07-	ATE	TP.A-092	19,8			
A3 (8P1) 1,6 PR 1ZF, 1ZM	05/03-	ATE	TP.A-092	19,8			
A3 (8P1) 1,6 FSI PR 1ZF, 1ZM	08/03-	ATE	TP.A-092	19,8			
A3 (8P1) 1,8 TFSI PR 1ZF, 1ZM	11/06-	ATE	TP.A-092	19,8			
A3 (8P1) 1,9 TDI PR 1ZC, 1ZF, 1ZM	05/03-	ATE	TP.A-092	19,8			
A3 (8P1) 2,0 FSI PR 1ZF, 1ZM	05/03-	ATE	TP.A-092	19,8			
A3 (8P1) 2,0 TFSI 16", PR 1ZF, 1ZM, Ø280,0 mm	09/04-	ATE	TP.A-092	19,8			
A3 (8P1) 2,0 TFSI 16", PR 1ZF, 1ZM, Ø312,0 mm	09/04-	ATE	TP.A-092	19,8			
A3 (8P1) 2,0 TDI 16", PR 1ZF, 1ZM, Ø280,0 mm	05/03-	ATE	TP.A-092	19,8			
A3 (8P1) 2,0 TDI 16", PR 1ZF, 1ZM, Ø288,0 mm	05/03-	ATE	TP.A-092	19,8			
A3 (8P1) 3,2 V6 Quattro PR 1ZC, 1ZF, 1ZM	07/03-	ATE	TP.A-092	19,8			
A3 (8P1) 3,2 V6 Quattro PR 1ZC	07/03-	ATE	TP.A-092	19,8			
A3 Convertible 1,6 PR 1ZF	09/08-	ATE	TP.A-092	19,8			
A3 Convertible 1,8 TFSI PR 1ZF	04/08-	ATE	TP.A-092	19,8			
A3 Convertible 1,9 TDI PR 1ZF	04/08-	ATE	TP.A-092	19,8			
A3 Convertible 2,0 TFSI PR 1ZF	04/08-	ATE	TP.A-092	19,8			
A3 Convertible 2,0 TDI PR 1ZF	04/08-	ATE	TP.A-092	19,8			
A3 Hatchback (8PA) 1,4 TFSI PR 1ZF	09/07-	ATE	TP.A-092	19,8			
A3 Hatchback (8PA) 1,9 TDI PR 1ZC, 1ZF	09/04-	ATE	TP.A-092	19,8			
A3 Hatchback (8PA) 1,4 TFSI PR 1ZF, 1ZM	09/07-	ATE	TP.A-092	19,8			
A3 Hatchback (8PA) 1,6 1ZF, 1ZM	09/04-	ATE	TP.A-092	19,8			
A3 Hatchback (8PA) 1,6 FSI PR 1ZF, 1ZM	09/04-	ATE	TP.A-092	19,8			
A3 Hatchback (8PA) 1,8 TFSI PR 1ZF, 1ZM	11/06-	ATE	TP.A-092	19,8			
A3 Hatchback (8PA) 2,0 FSI PR 1ZF, 1ZM	09/04-	ATE	TP.A-092	19,8			
A3 Hatchback (8PA) 2,0 TFSI 16", PR 1ZF, 1ZM, Ø280,0 mm	09/04-	ATE	TP.A-092	19,8			
A3 Hatchback (8PA) 2,0 TFSI 16", PR 1ZF, 1ZM, Ø312,0 mm	09/04-	ATE	TP.A-092	19,8			
A3 Hatchback (8PA) 2,0 TFSI Quattro, 16", PR 1ZF, 1ZM	09/04-	ATE	TP.A-092	19,8			
A3 Hatchback (8PA) 2,0 TDI 16", PR 1ZF, 1ZM, Ø280,0 mm	09/04-	ATE	TP.A-092	19,8			
A3 Hatchback (8PA) 2,0 TDI 16", PR 1ZF, 1ZM, Ø288,0 mm	09/04-	ATE	TP.A-092	19,8			

Марка автомобиля	Годы выпуска автомобиля	Передние колодки			Задние колодки		
		Тип тормозной системы	№ по каталогу	Толщина изделия, мм	Тип тормозной системы	№ по каталогу	Толщина изделия, мм
AUDI							
A3 Hatchback (8PA) 2,0 TDI Quattro, 16", PR 1ZF, 1ZM	01/06-	ATE	TP.A-092	19,8			
A3 Hatchback (8PA) 3,2 V6 Quattro, 16", PR 1ZF, 1ZM	09/04-	ATE	TP.A-092	19,8			
A3 Hatchback (8PA) 2,0 TDI 16", PR 1ZF, 1ZM	09/04-	ATE	TP.A-092	19,8			
A3 Hatchback (8PA) 2,0 TDI Ø280,0 mm	09/04-	ATE	TP.A-092	19,8			
A3 Hatchback (8PA) 2,0 TDI Ø288,0 mm	09/04-	ATE	TP.A-092	19,8			
A3 Hatchback (8PA) 2,0 TDI Quattro, 16", PR 1ZF, 1ZM	01/06-	ATE	TP.A-092	19,8			
A3 Hatchback (8PA) 3,2 V6 Quattro, 16", PR 1ZF, 1ZM	09/04-	ATE	TP.A-092	19,8			
A3 Sportback (8PA) 1,2 TSI	04/10 –	ATE	TP.A-093	19,8			
A3 Sportback (8PA) 1,4 TFSI	09/07 –	ATE	TP.A-093	19,8			
A3 Sportback (8PA) 1,6	09/04 –	ATE	TP.A-093	19,8			
A3 Sportback (8PA) 1,6 FSI	09/04 –	ATE	TP.A-093	19,8			
A3 Sportback (8PA) 1,6 TDI	05/09 –	ATE	TP.A-093	19,8			
A3 Sportback (8PA) 1,8 TFSI	11/06 –	ATE	TP.A-093	19,8			
A3 Sportback (8PA) 1,8 TFSI Quattro	07/08 –	ATE	TP.A-093	19,8			
A3 Sportback (8PA) 1,9 TDI	09/04 – 05/10	ATE	TP.A-093	19,8			
A3 Sportback (8PA) 2,0 FSI	09/04 –	ATE	TP.A-093	19,8			
A3 Sportback (8PA) 2,0 TDI	06/05 –	ATE	TP.A-093	19,8			
A3 Sportback (8PA) 2,0 TDI 16V	09/04 –	ATE	TP.A-093	19,8			
A3 Sportback (8PA) 2,0 TDI 16V Quattro	11/05 –	ATE	TP.A-093	19,8			
A3 Sportback (8PA) 2,0 TFSI (Quattro)	09/04 –	ATE	TP.A-093	19,8			
A3 Sportback (8PA) 3,2 V6 Quattro	09/04 – 05/09	ATE	TP.A-093	19,8			
A4 1,6	94-				GIR	TP.A 007	16,4
A4 1,6i 16V (ABS)	94-	GIR	TP.A 003	19,4	GIR	TP.A 007	16,4
A4 1,8 (ABS)	94-	ATE	TP.A 019	19,5	GIR	TP.A 007	16,4
A4 1,8 20V Turbo, Quattro	94-	ATE	TP.A 019	19,5	GIR	TP.A 007	16,4
A4 1,8 20V, Quattro	94-	ATE	TP.A 019	19,5	GIR	TP.A 007	16,4
A4 1,8 Turbo 4x4 (ABS)	94-	ATE	TP.A 019	19,5	GIR	TP.A 007	16,4
A4 2,6i 4x4 (ABS)	94-	ATE	TP.A 019	19,5	GIR	TP.A 007	16,4
A4 2,6 V 6 Quattro	94-	ATE	TP.A 019	19,5	GIR	TP.A 007	16,4
A4 2,8i 4x4 (ABS)	94-	ATE	TP.A 019	19,5	GIR	TP.A 007	16,4
A4 2,8 V 6 Quattro	94-	ATE	TP.A 019	19,5	GIR	TP.A 007	16,4
A4 1,9 TDI (ABS)	94-	GIR	TP.A 003	19,4	GIR	TP.A 007	16,4
A4 Estate (8ED) 4,2 RS4 Quattro	09/05-				TRW	TP.A-111	17,5
A4 (8E2, B6) 4,2 S4 Quattro PR 1KE	03/03-12/04				TRW	TP.A-111	17,5
A4 (8E2, B6) 1,6	11/00 – 12/04				GIR	TP.A-014	17,4
A4 (8E2, B6) 1,8 T	11/00 – 12/04				GIR	TP.A-014	17,4
A4 (8E2, B6) 1,8 T Quattro	11/00 – 12/04				GIR	TP.A-014	17,4

Марка автомобиля	Годы выпуска автомобиля	Передние колодки			Задние колодки		
		Тип тормозной системы	№ по каталогу	Толщина изделия, мм	Тип тормозной системы	№ по каталогу	Толщина изделия, мм
AUDI							
A4 (8E2, B6) 1,9 TDI	11/00 – 12/04				GIR	TP.A-014	17,4
A4 (8E2, B6) 1,9 TDI Quattro	11/01 – 12/04				GIR	TP.A-014	17,4
A4 (8E2, B6) 2,0	11/00 – 12/04				GIR	TP.A-014	17,4
A4 (8E2, B6) 2,0 FSI	07/02 – 12/04				GIR	TP.A-014	17,4
A4 (8E2, B6) 2,4	09/01 – 12/04				GIR	TP.A-014	17,4
A4 (8E2, B6) 2,5 TDI	08/01 – 12/04				GIR	TP.A-014	17,4
A4 (8E2, B6) 2,5 TDI Quattro	11/00 – 12/04				GIR	TP.A-014	17,4
A4 (8E2, B6) 3,0	11/00 – 12/04				GIR	TP.A-014	17,4
A4 (8E2, B6) 3,0 Quattro	11/00 – 12/04				GIR	TP.A-014	17,4
A4 (8EC, B7) 1,6	11/04 – 06/08				GIR	TP.A-014	17,4
A4 (8EC, B7) 1,8 T	11/04 – 06/08				GIR	TP.A-014	17,4
A4 (8EC, B7) 1,9 TDI	11/04 – 06/08				GIR	TP.A-014	17,4
A4 (8EC, B7) 2,0	11/04 – 06/08				GIR	TP.A-014	17,4
A4 (8EC, B7) 2,0 TDI (16V)	11/04 – 06/08				GIR	TP.A-014	17,4
A4 (8EC, B7) 2,0 TDI Quattro	01/06 – 06/08				GIR	TP.A-014	17,4
A4 (8EC) 2,0 TFSI PR 1KE	11/04-				TRW	TP.A-111	17,5
A4 (8EC) 4,2 RS4 Quattro -05/07	09/05-				TRW	TP.A-111	17,5
A4 (8EC) 4,2 S4 Quattro	11/04-				TRW	TP.A-111	17,5
A4 Convertible (8H7, 8HE) 2,0 TFSI Quattro	11/05-				TRW	TP.A-111	17,5
A4 Convertible (8H7, 8HE) 3,2 FSI PR 1KE	01/06-				TRW	TP.A-111	17,5
A4 Convertible (8H7, 8HE) 3,2 FSI Quattro PR 1KE	01/06-				TRW	TP.A-111	17,5
A4 Convertible (8H7, 8HE) 4,2 RS4 Quattro	06/06-				TRW	TP.A-111	17,5
A4 Convertible (8H7, 8HE) S4 Quattro, -10/05, PR 1KE	03/04-				TRW	TP.A-111	17,5
A4 Avant (8D5, B5) 1,6	11/94 – 09/01	GIR	TP.A-003	19,4	GIR	TP.A-007	16,4
A4 Avant (8D5, B5) 1,8	07/95 – 09/01				GIR	TP.A-007	16,4
A4 Avant (8D5, B5) 1,8 Quattro	07/95 – 09/01				GIR	TP.A-007	16,4
A4 Avant (8D5, B5) 1,8 T	03/96 – 09/01				GIR	TP.A-007	16,4
A4 Avant (8D5, B5) 1,8 T Quattro	01/96 – 09/01				GIR	TP.A-007	16,4
A4 Avant (8D5, B5) 1,9 Di / TDI	02/96 – 09/01	GIR	TP.A-003	19,4	GIR	TP.A-007	16,4

Марка автомобиля	Годы выпуска автомобиля	Передние колодки			Задние колодки		
		Тип тормозной системы	№ по каталогу	Толщина изделия, мм	Тип тормозной системы	№ по каталогу	Толщина изделия, мм
AUDI							
A4 Avant (8D5, B5) 1,9 TDI Quattro	09/96 – 09/01				GIR	TP.A-007	16,4
A4 Avant (8D5, B5) 2,4 Quattro	03/97 – 09/01				GIR	TP.A-007	16,4
A4 Avant (8D5, B5) 2,5 TDI Quattro	09/97 – 09/01				GIR	TP.A-007	16,4
A4 Avant (8D5, B5) 2,6	02/96 – 09/01				GIR	TP.A-007	16,4
A4 Avant (8D5, B5) 2,6 Quattro	01/96 – 09/01				GIR	TP.A-007	16,4
A4 Avant (8D5, B5) 2,8	03/96 – 09/01				GIR	TP.A-007	16,4
A4 Avant (8D5, B5) 2,8 Quattro	10/96 – 09/01				GIR	TP.A-007	16,4
A4 Avant (8D5, B5) S4 Quattro	09/97 – 09/01				GIR	TP.A-007	16,4
A4 Avant (8E5, B6) 1,6	09/01 – 12/04				GIR	TP.A-014	17,4
A4 Avant (8E5, B6) 1,8 T	09/01 – 12/04				GIR	TP.A-014	17,4
A4 Avant (8E5, B6) 1,8 T Quattro	09/01 – 12/04				GIR	TP.A-014	17,4
A4 Avant (8E5, B6) 1,9 TDI	09/01 – 12/04				GIR	TP.A-014	17,4
A4 Avant (8E5, B6) 1,9 TDI Quattro	11/01 – 12/04				GIR	TP.A-014	17,4
A4 Avant (8E5, B6) 2,0	09/01 – 12/04				GIR	TP.A-014	17,4
A4 Avant (8E5, B6) 2,0 FSI	07/02 – 12/04				GIR	TP.A-014	17,4
A4 Avant (8E5, B6) 2,4	09/01 – 12/04				GIR	TP.A-014	17,4
A4 Avant (8E5, B6) 2,5 TDI	09/01 – 12/04				GIR	TP.A-014	17,4
A4 Avant (8E5, B6) 2,5 TDI Quattro	09/01 – 12/04				GIR	TP.A-014	17,4
A4 Avant (8E5, B6) 3,0	04/01 – 12/04				GIR	TP.A-014	17,4
A4 Avant (8E5, B6) 3,0 Quattro	04/01 – 12/04				GIR	TP.A-014	17,4
A4 Avant (8ED, B7) 1,6	11/04 – 06/08				GIR	TP.A-014	17,4
A4 Avant (8ED, B7) 1,8 T	11/04 – 06/08				GIR	TP.A-014	17,4
A4 Avant (8ED, B7) 1,8 T Quattro	11/04 – 06/08				GIR	TP.A-014	17,4
A4 Avant (8ED, B7) 1,9 TDI	11/04 – 06/08				GIR	TP.A-014	17,4
A4 Avant (8ED, B7) 2,0	11/04 – 06/08				GIR	TP.A-014	17,4
A4 Avant (8ED, B7) 2,0 TDI (16V)	11/04 – 06/08				GIR	TP.A-014	17,4
A4 Avant (8ED, B7) 2,0 TDI Quattro	01/06 – 06/08				GIR	TP.A-014	17,4
A4 Avant (8ED, B7) 2,0 TFSI	11/04 – 06/08				GIR	TP.A-014	17,4

Марка автомобиля	Годы выпуска автомобиля	Передние колодки			Задние колодки		
		Тип тормозной системы	№ по каталогу	Толщина изделия, мм	Тип тормозной системы	№ по каталогу	Толщина изделия, мм
AUDI							
A4 Avant (8ED, B7) 2,7 TDI	11/05 – 06/08				GIR	TP.A-014	17,4
A4 Estate (8E5, B6) 4,2 S4 Quattro, PR 1KE	03/03-12/04				TRW	TP.A-111	17,5
A4 Estate (8ED) 4,2 Quattro -05/07	09/05-				TRW	TP.A-111	17,5
A4 Estate (8ED) 4,2 Quattro	11/04-				TRW	TP.A-111	17,5
A4 Estate (8ED) 4,2 RS6	07/02-01/05				TRW	TP.A-111	17,5
A4 Convertible (8H7, B6, 8HE, B7) 1,8 T	07/02 – 03/09				GIR	TP.A-014	17,4
A4 Convertible (8H7, B6, 8HE, B7) 1,8 T Quattro	05/03 – 03/09				GIR	TP.A-014	17,4
A4 Convertible (8H7, B6, 8HE, B7) 2,0	09/04 – 12/05				GIR	TP.A-014	17,4
A4 Convertible (8H7, B6, 8HE, B7) 2,0 TDI	01/06 – 03/09				GIR	TP.A-014	17,4
A4 Convertible (8H7, B6, 8HE, B7) 2,0 TFSI 16V	01/06 – 03/09				GIR	TP.A-014	17,4
A4 Convertible (8H7, B6, 8HE, B7) 2,4	04/02 – 12/05				GIR	TP.A-014	17,4
A4 Convertible (8H7, B6, 8HE, B7) 2,5 TDI	08/02 – 12/05				GIR	TP.A-014	17,4
A4 Convertible (8H7, B6, 8HE, B7) 2,7 TDI	06/06 – 03/09				GIR	TP.A-014	17,4
A4 Convertible (8H7, B6, 8HE, B7) 3,0	04/02 – 12/05				GIR	TP.A-014	17,4
A4 Convertible (8H7, B6, 8HE, B7) 3,0 Quattro	05/03 – 12/05				GIR	TP.A-014	17,4
A4 Sedan (8D2, B5) 1,6	11/94 – 10/00	GIR	TP.A-003	19,4	GIR	TP.A-007	16,4
A4 Sedan (8D2, B5) 1,8	01/95 – 11/00				GIR	TP.A-007	16,4
A4 Sedan (8D2, B5) 1,8 Quattro	01/95 – 11/00				GIR	TP.A-007	16,4
A4 Sedan (8D2, B5) 1,8 T	01/95 – 11/00				GIR	TP.A-007	16,4
A4 Sedan (8D2, B5) 1,8 T Quattro	01/95 – 11/00				GIR	TP.A-007	16,4
A4 Sedan (8D2, B5) 1,9 Di / TDI	01/95 – 11/00	GIR	TP.A-003	19,4	GIR	TP.A-007	16,4
A4 Sedan (8D2, B5) 1,9 TDI Quattro	09/96 – 11/00				GIR	TP.A-007	16,4
A4 Sedan (8D2, B5) 2,4 Quattro	03/97 – 11/00				GIR	TP.A-007	16,4
A4 Sedan (8D2, B5) 2,5 TDI Quattro	09/97 – 11/00				GIR	TP.A-007	16,4
A4 Sedan (8D2, B5) 2,6	01/95 – 11/00				GIR	TP.A-007	16,4
A4 Sedan (8D2, B5) 2,6 Quattro	01/95 – 11/00				GIR	TP.A-007	16,4
A4 Sedan (8D2, B5) 2,8	09/95 – 11/00				GIR	TP.A-007	16,4
A4 Sedan (8D2, B5) 2,8 Quattro	01/95 – 08/01				GIR	TP.A-007	16,4
A4 Sedan (8D2, B5) S4 Quattro	09/97 – 09/01				GIR	TP.A-007	16,4

Марка автомобиля	Годы выпуска автомобиля	Передние колодки			Задние колодки		
		Тип тормозной системы	№ по каталогу	Толщина изделия, мм	Тип тормозной системы	№ по каталогу	Толщина изделия, мм
AUDI							
A4 Sedan (8EC, B7) 1,6	11/04 – 06/08				GIR	TP.A-014	17,4
A4 Sedan (8EC, B7) 1,8 T	11/04 – 06/08				GIR	TP.A-014	17,4
A4 Sedan (8EC, B7) 1,9 TDI	11/04 – 06/08				GIR	TP.A-014	17,4
A4 Sedan (8EC, B7) 2,0	11/04 – 06/08				GIR	TP.A-014	17,4
A4 Sedan (8EC, B7) 2,0 TDI Quattro	01/06 – 06/08				GIR	TP.A-014	17,4
A4 Sedan (8EC, B7) 2,0 TDI (16V)	11/04 – 06/08				GIR	TP.A-014	17,4
A4 Sedan (8EC, B7) 2,0 TFSI	06/05 – 06/08				TRW	TP.A-111	17,5
A4 Sedan (8EC, B7) 2,0 TFSI Quattro	06/05 – 06/08				TRW	TP.A-111	17,5
A4 Sedan (8EC, B7) 3,0 TDI Quattro	11/04 – 06/08				TRW	TP.A-111	17,5
A4 Sedan (8EC, B7) RS4 Quattro	09/05 – 06/08				TRW	TP.A-111	17,5
A4 Sedan (8EC, B7) S4 Quattro	11/04 – 06/08				TRW	TP.A-111	17,5
A6 1,8 all models (ABS)	95-	ATE	TP.A 019	19,5	GIR	TP.A 007	16,4
A6 1,8 T (ABS)	97-	ATE	TP.A 019	19,5	GIR	TP.A 014	17,4
A6 1,9 all models (ABS)	94-	ATE	TP.A 019	19,5	GIR	TP.A 007	16,4
A6 2,4 V 30 (ABS)	97-	ATE	TP.A 019	19,5	GIR	TP.A 014	17,4
A6 2,8 V 30 (ABS)	97-	ATE	TP.A 019	19,5	GIR	TP.A 014	17,4
A6 2,0 all models (ABS)	94-	ATE	TP.A 019	19,5	GIR	TP.A 007	16,4
A6 2,3i (ABS)	94-	ATE	TP.A 019	19,5	GIR	TP.A 007	16,4
A6 2,6i (ABS)	94-				GIR	TP.A 007	16,4
A6 2,8i (ABS)	94-				GIR	TP.A 007	16,4
A6 1,9 TDI (ABS)	97-	ATE	TP.A 019	19,5	GIR	TP.A 014	17,4
A6 2,5 TDI (ABS)	97-	ATE	TP.A 019	19,5	GIR	TP.A 014	17,4
A6 2,5 TDI (ABS)	94-	ATE	TP.A 019	19,5	GIR	TP.A 007	16,4
A6 Quattro 1,8 N (ABS)	97-	ATE	TP.A 019	19,5	GIR	TP.A 014	17,4
A6 Quattro 2,4 (ABS)	97-	ATE	TP.A 019	19,5	GIR	TP.A 014	17,4
A6 Quattro 2,8 (ABS)	97-	ATE	TP.A 019	19,5	GIR	TP.A 014	17,4
A6 (4F2) 2,8 FSI PR 1KW, 2EE	11/06-				TRW	TP.A-111	17,5
A6 (4F2) 3,0	08/04-05/06				TRW	TP.A-111	17,5
A6 (4F2) 3,2 FSI PR 1KW, 2EE	05/04-10/08				TRW	TP.A-111	17,5
A6 (4F2) 4,2 FSI Quattro PR 1KW, 2EE	05/04-10/08				TRW	TP.A-111	17,5
A6 (4F2) 4,2 Quattro PR 1KD, 2ED	05/04-05/06				TRW	TP.A-111	17,5
A6 (4F2) 4,2 Quattro PR 1KW, 2EE	05/04-05/06				TRW	TP.A-111	17,5
A6 (4F2) 5,0 RS6 Quattro PR 1KJ	09/08-				TRW	TP.A-111	17,5
A6 (4F2) 5,2 S6 Quattro PR 1KD, 2ED	03/06-				TRW	TP.A-111	17,5
A6 (4F2, C6) 2,0 TDI	07/04 – 03/11				TRW	TP.A-111	17,5
A6 (4F2, C6) 2,0 TFSI	06/05 – 03/11				TRW	TP.A-111	17,5

Марка автомобиля	Годы выпуска автомобиля	Передние колодки			Задние колодки		
		Тип тормозной системы	№ по каталогу	Толщина изделия, мм	Тип тормозной системы	№ по каталогу	Толщина изделия, мм
AUDI							
A6 (4F2, C6) 2,4	05/04 – 10/08				TRW	TP.A-111	17,5
A6 (4F2, C6) 2,4 Quattro	01/05 – 10/08				TRW	TP.A-111	17,5
A6 (4F2, C6) 2,7 TDI	11/04 – 03/11				TRW	TP.A-111	17,5
A6 (4F2, C6) 2,7 TDI Quattro	11/04 – 03/11				TRW	TP.A-111	17,5
A6 (4F2, C6) 2,8 FSI Quattro	06/07 – 03/11				TRW	TP.A-111	17,5
A6 (4F2, C6) 3,0 Quattro	05/04 – 05/06				TRW	TP.A-111	17,5
A6 (4F2, C6) 3,0 TDI Quattro	05/04 – 03/11				TRW	TP.A-111	17,5
A6 (4F2, C6) 3,0 TFSI Quattro	10/08 – 03/11				TRW	TP.A-111	17,5
A6 All road (4FH) 2,7 TDI Quattro, PR 1KW, 2EE	05/06-				TRW	TP.A-111	17,5
A6 All road (4FH) 3,0 TDI Quattro, PR 1KW	05/06-				TRW	TP.A-111	17,5
A6 All road (4FH) 4,2 FSI Quattro, PR 1KW	05/06-				TRW	TP.A-111	17,5
A6 All road (4FH, C6) 3,0 TFSI Quattro	10/08 – 08/11				TRW	TP.A-111	17,5
A6 All road (4FH, C6) 3,2 FSI Quattro	05/06 – 10/08				TRW	TP.A-111	17,5
A6 Avant (4A, C4) 1,8	12/95 – 12/97	ATE	TP.A-019	19,5	GIR	TP.A-007	16,4
A6 Avant (4A, C4) 1,8 Quattro	12/95 – 12/97	ATE	TP.A-019	19,5	GIR	TP.A-007	16,4
A6 Avant (4A, C4) 1,9 TDI	06/94 – 12/97	ATE	TP.A-019	19,5	GIR	TP.A-007	16,4
A6 Avant (4A, C4) 2,0	06/94 – 12/97	ATE	TP.A-019	19,5	GIR	TP.A-007	16,4
A6 Avant (4A, C4) 2,0 16V	06/94 – 12/97	ATE	TP.A-019	19,5	GIR	TP.A-007	16,4
A6 Avant (4A, C4) 2,0 16V Quattro	06/94 – 12/97	ATE	TP.A-019	19,5	GIR	TP.A-007	16,4
A6 Avant (4A, C4) 2,3	06/94 – 12/95	ATE	TP.A-019	19,5	GIR	TP.A-007	16,4
A6 Avant (4A, C4) 2,3 Quattro	06/94 – 12/95	ATE	TP.A-019	19,5	GIR	TP.A-007	16,4
A6 Avant (4A, C4) 2,5 TDI	06/94 – 12/97	ATE	TP.A-019	19,5	GIR	TP.A-007	16,4
A6 Avant (4A, C4) 2,5 TDI Quattro	07/95 – 12/97	ATE	TP.A-019	19,5	GIR	TP.A-007	16,4
A6 Avant (4A, C4) 2,6	06/94 – 12/97	ATE	TP.A-019	19,5	GIR	TP.A-007	16,4
A6 Avant (4A, C4) 2,6 Quattro	06/94 – 12/97	ATE	TP.A-019	19,5	GIR	TP.A-007	16,4
A6 Avant (4A, C4) 2,8	06/94 – 12/97	ATE	TP.A-019	19,5	GIR	TP.A-007	16,4
A6 Avant (4A, C4) 2,8 Quattro	06/94 – 12/97	ATE	TP.A-019	19,5	GIR	TP.A-007	16,4

Марка автомобиля	Годы выпуска автомобиля	Передние колодки			Задние колодки		
		Тип тормозной системы	№ по каталогу	Толщина изделия, мм	Тип тормозной системы	№ по каталогу	Толщина изделия, мм
AUDI							
A6 Avant (4A, C4) S6 4,2 Quattro	06/94 – 12/97				GIR	TP.A-007	16,4
A6 Avant (4A, C4) S6 Plus Quattro	04/96 – 12/97				GIR	TP.A-007	16,4
A6 Avant (4A, C4) S6 Turbo Quattro	06/94 – 12/97				GIR	TP.A-007	16,4
A6 Avant (4B, C5) 1,8 T	12/97 – 01/05				GIR	TP.A-014	17,4
A6 Avant (4B, C5) 1,8 T Quattro	12/97 – 01/05				GIR	TP.A-014	17,4
A6 Avant (4B, C5) 1,9 TDI	08/01 – 01/05				GIR	TP.A-014	17,4
A6 Avant (4B, C5) 2,0	08/01 – 01/05				GIR	TP.A-014	17,4
A6 Avant (4B, C5) 2,4	12/97 – 01/05				GIR	TP.A-014	17,4
A6 Avant (4B, C5) 2,4 Quattro	08/01 – 01/05				GIR	TP.A-014	17,4
A6 Avant (4B, C5) 2,5 TDI	02/00 – 01/05				GIR	TP.A-014	17,4
A6 Avant (4B, C5) 2,5 TDI Quattro	02/00 – 01/05				GIR	TP.A-014	17,4
A6 Avant (4B, C5) 2,7 T Quattro	08/01 – 01/05				GIR	TP.A-014	17,4
A6 Avant (4B, C5) 2,8	12/97 – 01/05				GIR	TP.A-014	17,4
A6 Avant (4B, C5) 3,0	08/01 – 01/05				GIR	TP.A-014	17,4
A6 Avant (4B, C5) 3,0 Quattro	08/01 – 01/05				GIR	TP.A-014	17,4
A6 Avant (4B, C5) 4,2 Quattro	11/98 – 01/05				GIR	TP.A-014	17,4
A6 Avant (4B, C5) S6 Quattro	09/99 – 01/05				GIR	TP.A-014	17,4
A6 Avant (4B, C5) RS6	07/02 – 01/05				TRW	TP.A-111	17,5
A6 Avant (4B, C5) RS6 Plus Quattro	04/04 – 01/05				TRW	TP.A-111	17,5
A6 Avant (4B, C5) RS6 Quattro	07/02 – 01/05				TRW	TP.A-111	17,5
A6 Avant (4F5, C6) 2,0 TDI	06/05 – 08/11				TRW	TP.A-111	17,5
A6 Avant (4F5, C6) 2,0 TFSI	06/05 – 08/11				TRW	TP.A-111	17,5
A6 Avant (4F5, C6) 2,4	03/05 – 10/08				TRW	TP.A-111	17,5
A6 Avant (4F5, C6) 2,4 Quattro	03/05 – 10/08				TRW	TP.A-111	17,5
A6 Avant (4F5, C6) 2,7 TDI	03/05 – 08/11				TRW	TP.A-111	17,5
A6 Avant (4F5, C6) 2,7 TDI Quattro	03/05 – 08/11				TRW	TP.A-111	17,5
A6 Avant (4F5, C6) 2,8 FSI	11/06 – 08/11				TRW	TP.A-111	17,5
A6 Avant (4F5, C6) 2,8 FSI Quattro	06/07 – 08/11				TRW	TP.A-111	17,5

Марка автомобиля	Годы выпуска автомобиля	Передние колодки			Задние колодки		
		Тип тормозной системы	№ по каталогу	Толщина изделия, мм	Тип тормозной системы	№ по каталогу	Толщина изделия, мм
AUDI							
A6 Avant (4F5, C6) 3,0	03/05 – 05/06				TRW	TP.A-111	17,5
A6 Avant (4F5, C6) 3,0 Quattro	03/05 – 05/06				TRW	TP.A-111	17,5
A6 Avant (4F5, C6) 3,0 TDI Quattro	03/05 – 08/11				TRW	TP.A-111	17,5
A6 Avant (4F5, C6) 3,0 TFSI Quattro	10/08 – 08/11				TRW	TP.A-111	17,5
A6 Avant (4F5, C6) 3,2 FSI	03/05 – 10/08				TRW	TP.A-111	17,5
A6 Avant (4F5, C6) 3,2 FSI Quattro	03/05 – 10/08				TRW	TP.A-111	17,5
A6 Avant (4F5, C6) 4,2 FSI Quattro	06/06 – 08/11				TRW	TP.A-111	17,5
A6 Avant (4F5, C6) 4,2 Quattro	03/05 – 05/06				TRW	TP.A-111	17,5
A6 Avant (4F5, C6) RS6 Quattro	04/08 – 08/10				TRW	TP.A-111	17,5
A6 Avant (4F5, C6) S6	03/06 – 08/11				TRW	TP.A-111	17,5
A6 Avant (4F5, C6) S6 Quattro	03/06 – 08/11				TRW	TP.A-111	17,5
A6 Estate (4B, C5) 4,2 RS6	07/02-01/05				TRW	TP.A-111	17,5
A6 Estate (4B, C5) 4,2 RS6 Plus	04/04-01/05				TRW	TP.A-111	17,5
A6 Estate (4B, C5) 4,2 Quattro	04/04-01/05				TRW	TP.A-111	17,5
A6 Estate (4F5) 3,2 FSI PR 1KW, 2EE	03/05-10/08				TRW	TP.A-111	17,5
A6 Estate (4F5) 3,2 FSI Quattro, PR 1KW, 2EE	03/05-10/08				TRW	TP.A-111	17,5
A6 Estate (4F5) 3,2 FSI Quattro, PR 1EE, 1KW	06/06-				TRW	TP.A-111	17,5
A6 Estate (4F5) 4,2 Quattro, PR 1KW, 2EE	03/05-				TRW	TP.A-111	17,5
A6 Estate (4F5) 5,0 RS6 Quattro, PR 1KW, 2EE	03/05-				TRW	TP.A-111	17,5
A6 Estate (4F5) 5,2 S6 Quattro, PR 1KW, 2EE	03/06-				TRW	TP.A-111	17,5
A6 Sedan (4A, C4) 1,8	12/95 – 10/97	ATE	TP.A-019	19,5	GIR	TP.A-007	16,4
A6 Sedan (4A, C4) 1,8 Quattro	12/95 – 10/97	ATE	TP.A-019	19,5	GIR	TP.A-007	16,4
A6 Sedan (4A, C4) 1,9 TDI	06/94 – 10/97	ATE	TP.A-019	19,5	GIR	TP.A-007	16,4
A6 Sedan (4A, C4) 2,0	06/94 – 10/97	ATE	TP.A-019	19,5	GIR	TP.A-007	16,4
A6 Sedan (4A, C4) 2,0 16V	06/94 – 10/97	ATE	TP.A-019	19,5	GIR	TP.A-007	16,4
A6 Sedan (4A, C4) 2,0 16V Quattro	06/94 – 10/97	ATE	TP.A-019	19,5	GIR	TP.A-007	16,4
A6 Sedan (4A, C4) 2,3	06/94 – 12/95	ATE	TP.A-019	19,5	GIR	TP.A-007	16,4
A6 Sedan (4A, C4) 2,3 Quattro	06/94 – 12/95	ATE	TP.A-019	19,5	GIR	TP.A-007	16,4
A6 Sedan (4A, C4) 2,5 TDI	06/94 – 10/97	ATE	TP.A-019	19,5	GIR	TP.A-007	16,4

Марка автомобиля	Годы выпуска автомобиля	Передние колодки			Задние колодки		
		Тип тормозной системы	№ по каталогу	Толщина изделия, мм	Тип тормозной системы	№ по каталогу	Толщина изделия, мм
AUDI							
A6 Sedan (4A, C4) 2,5 TDI Quattro	10/95 – 10/97	ATE	TP.A-019	19,5	GIR	TP.A-007	16,4
A6 Sedan (4A, C4) 2,6	06/94 – 10/97	ATE	TP.A-019	19,5	GIR	TP.A-007	16,4
A6 Sedan (4A, C4) 2,6 Quattro	06/94 – 10/97	ATE	TP.A-019	19,5	GIR	TP.A-007	16,4
A6 Sedan (4A, C4) 2,8	06/94 – 10/97	ATE	TP.A-019	19,5	GIR	TP.A-007	16,4
A6 Sedan (4A, C4) 2,8 Quattro	06/94 – 10/97	ATE	TP.A-019	19,5	GIR	TP.A-007	16,4
A6 Sedan (4A, C4) S6 4,2 Quattro	06/94 – 10/97				GIR	TP.A-007	16,4
A6 Sedan (4A, C4) S6 Plus Quattro	04/96 – 10/97				GIR	TP.A-007	16,4
A6 Sedan(4A, C4) S6 Turbo Quattro	06/94 – 10/97				GIR	TP.A-007	16,4
A6 Sedan (4B, C5) 1,8 T	01/97 – 01/05				GIR	TP.A-014	17,4
A6 Sedan (4B, C5) 1,8 T Quattro	02/97 – 01/05				GIR	TP.A-014	17,4
A6 Sedan (4B, C5) 1,9 TDI	08/01 – 01/05				GIR	TP.A-014	17,4
A6 Sedan (4B, C5) 2,0	08/01 – 01/05				GIR	TP.A-014	17,4
A6 Sedan (4B, C5) 2,4	02/97 – 01/05				GIR	TP.A-014	17,4
A6 Sedan (4B, C5) 2,4 Quattro	08/01 – 01/05				GIR	TP.A-014	17,4
A6 Sedan (4B, C5) 2,5 TDI	02/00 – 01/05				GIR	TP.A-014	17,4
A6 Sedan (4B, C5) 2,5 TDI Quattro	02/00 – 01/05				GIR	TP.A-014	17,4
A6 Sedan (4B, C5) 2,7 T Quattro	08/01 – 01/05				GIR	TP.A-014	17,4
A6 Sedan (4B, C5) 2,8	02/97 – 01/05				GIR	TP.A-014	17,4
A6 Sedan (4B, C5) 3,0	08/01 – 01/05				GIR	TP.A-014	17,4
A6 Sedan (4B, C5) 3,0 Quattro	08/01 – 01/05				GIR	TP.A-014	17,4
A6 Sedan (4B, C5) 4,2 Quattro	11/98 – 01/05				GIR	TP.A-014	17,4
A6 Sedan (4B, C5) S6 Quattro	09/99 – 01/05				GIR	TP.A-014	17,4
A6 Sedan (4B, C5) RS6 Quattro	07/02 – 01/05				TRW	TP.A-111	17,5
A6 Sedan (4F2, C6) 2,0 TDI	07/04 – 03/11				TRW	TP.A-111	17,5
A6 Sedan (4F2, C6) 2,0 TFSI	06/05 – 03/11				TRW	TP.A-111	17,5
A6 Sedan (4F2, C6) 2,4	05/04 – 10/08				TRW	TP.A-111	17,5
A6 Sedan (4F2, C6) 2,4 Quattro	01/05 – 10/08				TRW	TP.A-111	17,5
A6 Sedan (4F2, C6) 2,7 TDI	11/04 – 03/11				TRW	TP.A-111	17,5

Марка автомобиля	Годы выпуска автомобиля	Передние колодки			Задние колодки		
		Тип тормозной системы	№ по каталогу	Толщина изделия, мм	Тип тормозной системы	№ по каталогу	Толщина изделия, мм
AUDI							
A6 Sedan (4F2, C6) 2,7 TDI Quattro	11/04 – 03/11				TRW	TP.A-111	17,5
A6 Sedan (4F2, C6) 2,8 FSI	11/06 – 03/11				TRW	TP.A-111	17,5
A6 Sedan (4F2, C6) 2,8 FSI Quattro	06/07 – 03/11				TRW	TP.A-111	17,5
A6 Sedan (4F2, C6) 3,0 Quattro	05/04 – 05/06				TRW	TP.A-111	17,5
A6 Sedan (4F2, C6) 3,0 TDI Quattro	05/04 – 03/11				TRW	TP.A-111	17,5
A6 Sedan (4F2, C6) 3,0 TFSI Quattro	10/08 – 03/11				TRW	TP.A-111	17,5
A6 Sedan (4F2, C6) 3,2 FSI	05/04 – 05/09				TRW	TP.A-111	17,5
A6 Sedan (4F2, C6) 3,2 FSI Quattro	05/04 – 10/08				TRW	TP.A-111	17,5
A6 Sedan (4F2, C6) 4,2 FSI Quattro	06/06 – 03/11				TRW	TP.A-111	17,5
A6 Sedan (4F2, C6) 4,2 Quattro	05/04 – 05/06				TRW	TP.A-111	17,5
A6 Sedan (4F2, C6) RS6 Quattro	09/08 – 08/10				TRW	TP.A-111	17,5
A6 Sedan (4F2, C6) S6	03/06 – 03/11				TRW	TP.A-111	17,5
A6 Sedan (4F2, C6) S6 Quattro	03/06 – 03/11				TRW	TP.A-111	17,5
A8 2,8 all models (ABS)	94-				GIR	TP.A 007	16,4
A8 3,7 all models (ABS)	95-				GIR	TP.A 007	16,4
A8 4/2 all models (ABS)	94-				GIR	TP.A 007	16,4
A8 Sedan (4D2, 4D8) 2,5 TDI	01/97 – 04/00				GIR	TP.A-007	16,4
A8 Sedan (4D2, 4D8) 2,5 TDI Quattro	07/97 – 04/00				GIR	TP.A-007	16,4
A8 Sedan (4D2, 4D8) 2,8	03/94 – 09/02				GIR	TP.A-007	16,4
A8 Sedan (4D2, 4D8) 2,8 Quattro	03/94 – 09/02				GIR	TP.A-007	16,4
A8 Sedan (4D2, 4D8) 3,7	07/95 – 12/98				GIR	TP.A-007	16,4
A8 Sedan (4D2, 4D8) 3,7 Quattro	07/95 – 11/98				GIR	TP.A-007	16,4
A8 Sedan (4D2, 4D8) 4,2 Quattro	03/94 – 11/98				GIR	TP.A-007	16,4
A8 Sedan (4D2, 4D8) S 8 Quattro	07/96 – 06/99				GIR	TP.A-007	16,4
A8 Sedan (4E_) 2,8 FSI	08/07 – 07/10				TRW	TP.A-111	17,5
A8 Sedan (4E_) 3,0	07/03 – 05/06				TRW	TP.A-111	17,5
A8 Sedan (4E_) 3,0 TDI Quattro	08/03 – 07/10				TRW	TP.A-111	17,5
A8 Sedan (4E_) 3,2 FSI	06/05 – 07/10				TRW	TP.A-111	17,5

Марка автомобиля	Годы выпуска автомобиля	Передние колодки			Задние колодки		
		Тип тормозной системы	№ по каталогу	Толщина изделия, мм	Тип тормозной системы	№ по каталогу	Толщина изделия, мм
AUDI							
A8 Sedan (4E_) 3,2 FSI Quattro	06/05 – 07/10				TRW	TP.A-111	17,5
A8 Sedan (4E_) 3,7 Quattro	10/02 – 05/06				TRW	TP.A-111	17,5
A8 Sedan (4E_) 4,0 TDI Quattro	05/03 – 07/05				TRW	TP.A-111	17,5
A8 Sedan (4E_) 4,2 FSI Quattro	06/06 – 07/10				TRW	TP.A-111	17,5
A8 Sedan (4E_) 4,2 Quattro	10/02 – 07/10				TRW	TP.A-111	17,5
A8 Sedan (4E_) 4,2 TDI Quattro	01/05 – 07/10				TRW	TP.A-111	17,5
A8 Sedan (4E_) 6,0 W12 Quattro	12/03 – 07/10				TRW	TP.A-111	17,5
A8 Sedan (4E_) S8	06/06 – 07/10				TRW	TP.A-111	17,5
A8 Sedan (4E_) S8 Quattro	06/06 – 07/10				TRW	TP.A-111	17,5
A8 Space Frame 2,8 V 6 Quattro (ABS)	94-				GIR	TP.A 007	16,4
A8 Space Frame 3,7 V 8 (ABS)	94-				GIR	TP.A 007	16,4
A8 Space Frame 4,2 V 6 Quattro (ABS)	94-				GIR	TP.A 007	16,4
A8 (4E_) 4,2 TDI Quattro PR 1KE, 1KW, 1KY, 1KZ, Ø280,0 mm	10/02-				TRW	TP.A-111	17,5
A8 (4E_) 4,2 TDI Quattro PR 1KE, 1KW, 1KY, 1KZ, Ø310,0 mm	10/02-				TRW	TP.A-111	17,5
A8 (4E_) 6,0 W12 Quattro -03/05 Ch.→4E70300000, PR 1KE, 1KW, 1KY, 1KZ, Ø280,0 mm	12/03-				TRW	TP.A-111	17,5
A8 (4E_) 6,0 W12 Quattro -03/05 Ch.→4E70300000, PR 1KE, 1KW, 1KY, 1KZ, Ø310,0 mm	12/03-				TRW	TP.A-111	17,5
A8 (4E_) 5,2 S8 Quattro	06/06-				TRW	TP.A-111	17,5
A8 (4E_) 6,0 W12 Quattro -04/05, Ch.: 4FE8000001, →, PR 1KU	12/03-				TRW	TP.A-111	17,5
A8 (4E_) 2,8 FSI PR 1KE	08/07-				TRW	TP.A-111	17,5
A8 (4E_) 3,0 PR 1KE, 1KW, 1KJ, 1KZ, Ø280,0 mm	07/03-				TRW	TP.A-111	17,5
A8 (4E_) 3,0 PR 1KE, 1KW, 1KJ, 1KZ, Ø310,0 mm	07/03-				TRW	TP.A-111	17,5
A8 (4E_) 3,0 Long Quattro PR 1KE, 1KW, 1KJ, 1KZ, Ø310,0 mm	08/03-05/06				TRW	TP.A-111	17,5
A8 (4E_) 3,0 TDI Quattro PR 1KE, 1KW, 1KJ, 1KZ, Ø280,0 mm	08/03-				TRW	TP.A-111	17,5
A8 (4E_) 3,0 TDI Quattro PR 1KE, 1KW, 1KJ, 1KZ, Ø310,0 mm	08/03-				TRW	TP.A-111	17,5
A8 (4E_) 3,2 FSI PR 1KE, 1KW, 1KJ, 1KZ,	06/05-				TRW	TP.A-111	17,5
A8 (4E_) 3,2 FSI Quattro PR 1KE, 1KW, 1KJ, 1KZ	06/05-				TRW	TP.A-111	17,5
A8 (4E_) 3,7 Quattro PR 1KE, 1KW, 1KJ, 1KZ, Ø280,0 mm	10/02-				TRW	TP.A-111	17,5
A8 (4E_) 3,7 Quattro PR 1KE, 1KW, 1KJ, 1KZ, Ø310,0 mm	10/02-				TRW	TP.A-111	17,5
A8 (4E_) 4,0 TDI Quattro PR 1KE	03/03-				TRW	TP.A-111	17,5

Марка автомобиля	Годы выпуска автомобиля	Передние колодки			Задние колодки		
		Тип тормозной системы	№ по каталогу	Толщина изделия, мм	Тип тормозной системы	№ по каталогу	Толщина изделия, мм
BMW							
1500 1,5 S	69-71	ATE	TP.A 001	15,0			
1502 1,6 all models	-77	ATE	TP.A 001	15,0			
316i 1,6i	88-90	GIR	TP.A 020	17,0	ATE	TP.A-008	17,0
316i Compact 1,6i	94-				ATE	TP.A 042	17,0
316i Coupe (E36)	09/93 – 04/99				ATE	TP.A-042	17,0
316i Sedan (E30)	08/87 – 06/91	GIR	TP.A-020	17,0	ATE	TP.A-008	17,0
316i Sedan (E36)	09/90 – 02/98				ATE	TP.A-042	17,0
316i Touring (E30)	09/91 – 06/94	GIR	TP.A-020	17,0	ATE	TP.A-008	17,0
318 Diesel 1,7 all models	94-				ATE	TP.A 042	17,0
318i 1,8i 16 V S (ABS)	93-				ATE	TP.A 042	17,0
318i 1,8i SE, Executive (ABS)	93-				ATE	TP.A 042	17,0
318i Compact 1,8i	94-				ATE	TP.A 042	17,0
318i (E30)	09/82 – 06/91	GIR	TP.A-020	17,0	ATE	TP.A-008	17,0
318i Convertible (E30)	09/90 – 10/93	GIR	TP.A-020	17,0	ATE	TP.A-008	17,0
318i Sedan (E30)	09/82 – 06/91	GIR	TP.A-020	17,0	ATE	TP.A-008	17,0
318i Touring (E30)	09/87 – 06/94	GIR	TP.A-020	17,0	ATE	TP.A-008	17,0
318 is (E30)	09/89 – 08/91	GIR	TP.A-020	17,0	ATE	TP.A-008	17,0
318 is Coupe (E36)	03/92 – 04/99				ATE	TP.A-042	17,0
318 is Sedan (E30)	09/89 – 08/91	GIR	TP.A-020	17,0	ATE	TP.A-008	17,0
318 is (TDS) Sedan (E36)	01/95 – 02/98				ATE	TP.A-042	17,0
320i 2,0i (ABS)	90-	GIR	TP.A 020	17,0	ATE	TP.A 042	17,0
320i 2,0i 16 VS, 2,0i 24 V (ABS)	93-				ATE	TP.A 042	17,0
320i 2,0i 16 VS, 2,0i 24V Executive SE(ABS)	90-				ATE	TP.A 042	17,0
320i Convertible (E30)	04/86 – 10/93	GIR	TP.A-020	17,0	ATE	TP.A-008	17,0
320i Sedan (E30)	09/82 – 06/91	GIR	TP.A-020	17,0	ATE	TP.A-008	17,0
320i Touring (E30)	01/88 – 12/91	GIR	TP.A-020	17,0	ATE	TP.A-008	17,0
323i 2,3i	91-				ATE	TP.A 042	17,0
323i 2,3i Alpina	82-90	GIR	TP.A 020	17,0	ATE	TP.A-008	17,0
324 2,4 D, TD	86-	GIR	TP.A 020	17,0	ATE	TP.A-008	17,0
324 (D / TD) Sedan (E30)	09/85 – 08/91	GIR	TP.A-020	17,0	ATE	TP.A-008	17,0
324 TD Touring (E30)	01/88 – 06/93	GIR	TP.A-020	17,0	ATE	TP.A-008	17,0

Марка автомобиля	Годы выпуска автомобиля	Передние колодки			Задние колодки		
		Тип тормозной системы	№ по каталогу	Толщина изделия, мм	Тип тормозной системы	№ по каталогу	Толщина изделия, мм
BMW							
325 2,5 all models Diesel (ABS)	92-				ATE	TP.A 042	17,0
325i 2,5i	82-90	GIR	TP.A 020	17,0	ATE	TP.A-008	17,0
325i 2,5i 24 V, Executive SE (ABS)	89-				ATE	TP.A 042	17,0
325i 2,5i TD, TDSE, TDS Executive (ABS)	92-				ATE	TP.A 042	17,0
325i Convertible (E30)	12/85 – 10/93	GIR	TP.A-020	17,0	ATE	TP.A-008	17,0
325i (iX) Sedan (E30)	09/83 – 08/91	GIR	TP.A-020	17,0	ATE	TP.A-008	17,0
325i (iX) Touring (E30)	07/87 – 10/93	GIR	TP.A-020	17,0	ATE	TP.A-008	17,0
328i 2,8 all models (ABS)	94-				ATE	TP.A 042	17,0
518 1,8i	90-	ATE	TP.A 061	19,0			
518i 1,8i (ABS)	88-	ATE	TP.A 061	19,0	ATE	TP.A 042	17,0
518i 1,8; 1,8i, Executive (ABS)	92-				ATE	TP.A 042	17,0
518i Sedan (E34)	08/89 – 09/95	ATE	TP.A-061	19,0	ATE	TP.A-042	17,0
520i 2,0i (ABS)	88-				ATE	TP.A 042	17,0
520i 2,0i 24 V, Executive (ABS) (E 34)	90-	ATE	TP.A 061	19,0	ATE	TP.A 042	17,0
520i 2,0i, 24 V Touring (ABS)	88-				ATE	TP.A 042	17,0
520i (i 24V) Sedan (E34)	09/89 – 09/95	ATE	TP.A-061	19,0	ATE	TP.A-042	17,0
523i 2,5i	95-				ATE	TP.A 042	17,0
524 2,4 TD (ABS)	88-	ATE	TP.A 061	19,0	ATE	TP.A 042	17,0
524 TD Sedan (E34)	03/88 – 09/95	ATE	TP.A-061	19,0	ATE	TP.A-042	17,0
525 2,5 TD, TDS (ABS)	88-				ATE	TP.A 042	17,0
525 2,5 TD, TDS, Executive (ABS)	91-				ATE	TP.A 042	17,0
525 2,5 TDS 6 cyl	3/92		TP.A 061	19,0	ATE	TP.A 042	17,0
525i 2,5i	95-				ATE	TP.A 042	17,0
525i 2,5i 6 Cyl (E34)	88-2/90	ATE	TP.A 061	19,0	ATE	TP.A 042	17,0
525 2,5i 24v (E34)	3/90-	ATE	TP.A 061	19,0	ATE	TP.A 042	17,0
525i 2,7i E (ABS)	83-88				ATE	TP.A 042	17,0
525 2,7i E	88-2/90	ATE	TP.A 061	19,0	ATE	TP.A 042	17,0
525i (i 24V / iX 24V) Sedan (E34)	01/88 – 09/95	ATE	TP.A-061	19,0	ATE	TP.A-042	17,0
525 TD (TDS) Sedan (E34)	09/91 – 09/95	ATE	TP.A-061	19,0	ATE	TP.A-042	17,0
530i (i V8) Sedan (E34)	01/88 – 09/95	ATE	TP.A-061	19,0	ATE	TP.A-042	17,0
530i 3,0i (ABS)	88-				ATE	TP.A 042	17,0
530i 3,0i, 3,0i V8 Touring (E34)	88-	ATE	TP.A 061	19,0	ATE	TP.A 042	17,0
530 3,0i 8V Touring (E34)	2/88-	ATE	TP.A 061	19,0	ATE	TP.A 042	17,0
530 3,0i Combi (E34)	9/91-	ATE	TP.A 061	19,0	ATE	TP.A 042	17,0
531i 3,4i (ABS)	88-	ATE	TP.A 061	19,0	ATE	TP.A 042	17,0
535 3,5i Touring (E34)	2/90-	ATE	TP.A 061	19,0	ATE	TP.A 042	17,0

Марка автомобиля	Годы выпуска автомобиля	Передние колодки			Задние колодки		
		Тип тормозной системы	№ по каталогу	Толщина изделия, мм	Тип тормозной системы	№ по каталогу	Толщина изделия, мм
BMW							
535i Sedan (E34)	01/88 – 09/95	ATE	TP.A-061	19,0	ATE	TP.A-042	17,0
540i 4,0i V 8.32 (ABS)	88-				ATE	TP.A 042	17,0
540i V8 Sedan (E34)	09/92 – 09/95	ATE	TP.A-061	19,0	ATE	TP.A-042	17,0
540 4,0i 8V	3/92-	ATE	TP.A 061	19,0	ATE	TP.A 042	17,0
625 CS Coupe	78-85	ATE	TP.A 021	19,0	ATE	TP.A 042	17,0
628 CSi Coupe	82-87	ATE	TP.A 029	20,0	ATE	TP.A 008	17,0
633 CS Coupe	78-81	ATE	TP.A 021	19,0			
635 CSi Coupe	87-90	ATE	TP.A 029	20,0	ATE	TP.A 008	17,0
728 – 745i	77-86	ATE	TP.A 021	19,0	ATE	TP.A 001	15,0
728 – 745i	82-86	ATE	TP.A 021	19,0	ATE	TP.A 008	17,0
730i 3,0i V6 (ABS) (E32)	86-94	ATE	TP.A 061	19,0	ATE	TP.A 042	17,0
730i 3,0i V8 (ABS)	94-	ATE	TP.A 061	19,0	ATE	TP.A 042	17,0
730i (iL V8) Sedan (E32)	12/86 – 09/94	ATE	TP.A-061	19,0	ATE	TP.A-042	17,0
730 3,0i V8	4/92-	ATE	TP.A 061	19,0	ATE	TP.A 042	17,0
734 3,4i	86-	ATE	TP.A 061	19,0	ATE	TP.A 042	17,0
735i 3,5i (ABS)	86-				ATE	TP.A 042	17,0
735i, iL Sedan (E32)	09/86 – 09/92	ATE	TP.A-061	19,0	ATE	TP.A-042	17,0
740i 4,0i V8, 32L (ABS)	86-				ATE	TP.A 042	17,0
740i, iL V8 Sedan (E32)	04/92 – 09/94	ATE	TP.A-061	19,0	ATE	TP.A-042	17,0
740 4,0i V8	91-94	ATE	TP.A 061	19,0			
750 5,0i V8 (E32)	5/87-	ATE	TP.A 061	19,0			
750 5,0i (E32)	5/87-	ATE	TP.A 061	19,0	ATE	TP.A 042	17,0
750i 5,0i, 5,0i V 12, L, Executive (ABS)	86-				ATE	TP.A 042	17,0
750i, iL V12 Sedan (E32)	09/87 – 09/94	ATE	TP.A-061	19,0	ATE	TP.A-042	17,0
835 3,5i	2/90-	ATE	TP.A 061	19,0	ATE	TP.A 042	17,0
M3 1,8 all models	88-92	ATE	TP.A 029	17,0	ATE	TP.A 042	17,0
M3 2,3i 16 V, Sport	80-				ATE	TP.A 042	17,0
M3 3,0i 24 V	92-				ATE	TP.A 042	17,0
M3 3,0i 6 cyl Cabriolet	94-	ATE	TP.A 061	19,0	ATE	TP.A 042	17,0
M3 3,2 all models	94-				ATE	TP.A 042	17,0
M 3,6 (KAT) (E34)	10/88 – 05/92	ATE	TP.A-061	19,0	ATE	TP.A-042	17,0
M 3,6 (KAT) Sedan (E34)	10/88 – 05/92	ATE	TP.A-061	19,0	ATE	TP.A-042	17,0
M 3,8 Sedan (E34)	03/92 – 09/95	ATE	TP.A-061	19,0	ATE	TP.A-042	17,0
M KAT (E34)	10/88 – 05/92	ATE	TP.A-061	19,0	ATE	TP.A-042	17,0

Марка автомобиля	Годы выпуска автомобиля	Передние колодки			Задние колодки		
		Тип тормозной системы	№ по каталогу	Толщина изделия, мм	Тип тормозной системы	№ по каталогу	Толщина изделия, мм
BMW							
M KAT Sedan (E34)	10/88 – 05/92	ATE	TP.A-061	19,0	ATE	TP.A-042	17,0
M3 2,3 (E30)	07/86 – 06/91	ATE	TP.A-029	20,0	ATE	TP.A-042	17,0
M3 2,3 Convertible (E30)	06/88 – 06/91	ATE	TP.A-029	20,0			
M3 2,3 Sedan (E30)	07/86 – 06/91	ATE	TP.A-029	20,0	ATE	TP.A-042	17,0
M3 3,0 Coupe (E36)	10/92 – 10/95	ATE	TP.A-061	19,0	ATE	TP.A-042	17,0
M3 3,0 Sedan (E36)	08/94 – 09/95	ATE	TP.A-061	19,0	ATE	TP.A-042	17,0
M3 3,2 Coupe (E36)	10/95 – 04/99	ATE	TP.A-061	19,0	ATE	TP.A-042	17,0
M3 3,2 Sedan (E36)	09/95 – 02/98	ATE	TP.A-061	19,0	ATE	TP.A-042	17,0
M3 EVO I 2,3 (E30)	10/88 – 10/90	ATE	TP.A-029	20,0	ATE	TP.A-042	17,0
M3 EVO II 2,5 (E30)	01/90 – 01/92	ATE	TP.A-029	20,0	ATE	TP.A-042	17,0
M3 EVO I 2,3 Sedan (E30)	10/88 – 10/90	ATE	TP.A-029	20,0	ATE	TP.A-042	17,0
M3 EVO II 2,5 Sedan (E30)	01/90 – 01/92	ATE	TP.A-029	20,0	ATE	TP.A-042	17,0
M5 3,5i 24 V (ABS)	88-				ATE	TP.A 042	17,0
M5 3,8i 24 V Executive (ABS)	92-	ATE	TP.A 061	19,0	ATE	TP.A 042	17,0
M535 3,5i (E34)	88-8/89-	ATE	TP.A 061	19,0	ATE	TP.A 042	17,0
M535 3,5i (E34)	9/89-	ATE	TP.A 061	19,0	ATE	TP.A 042	17,0
Z1 2,5i (ABS)	89-	GIR	TP.A-020	17,0	ATE	TP.A 042	17,0
Z3 1,8	96-				ATE	TP.A 042	17,0
Z3 1,9	96-				ATE	TP.A 042	17,0
Z3 2,2 (E36)	08/00 – 01/03				ATE	TP.A-042	17,0
Z3 2,8 (E36)	04/97 – 06/00				ATE	TP.A-042	17,0
Z3 M Coupe (E36)	02/98 – 06/03	ATE	TP.A-061	19,0	ATE	TP.A-042	17,0
Z3 M 3,2 (E36)	03/97 – 01/03	ATE	TP.A-061	19,0	ATE	TP.A-042	17,0
BOVA							
Futura (340, 381, 428 л.с.)	2001 –	KNORR SB 7000	TP.A-115	30,0	KNORR SB 7000	TP.A-115	30,0
Futura (310, 360 л.с.)	2006 –	KNORR SB 7000	TP.A-115	30,0	KNORR SB 7000	TP.A-115	30,0
Lexio (310, 360 л.с.)	2005 –	KNORR SB 7000	TP.A-115	30,0	KNORR SB 7000	TP.A-115	30,0
Magiq (340, 381, 428 л.с.)	1999 –	KNORR SB 7000	TP.A-115	30,0	KNORR SB 7000	TP.A-115	30,0
Magiq (408 л.с.)	2006 –	KNORR SB 7000	TP.A-115	30,0	KNORR SB 7000	TP.A-115	30,0

Марка автомобиля	Годы выпуска автомобиля	Передние колодки			Задние колодки		
		Тип тормозной системы	№ по каталогу	Толщина изделия, мм	Тип тормозной системы	№ по каталогу	Толщина изделия, мм
BOVA							
Magiq (462 л.с.)	2007 –	KNORR SB 7000	TP.A-115	30,0	KNORR SB 7000	TP.A-115	30,0
Synergy (428, 483 л.с.)	2004 –	KNORR SB 7000	TP.A-115	30,0	KNORR SB 7000	TP.A-115	30,0
Synergy (462, 510 л.с.)	2007 –	KNORR SB 7000	TP.A-115	30,0	KNORR SB 7000	TP.A-115	30,0
CHEVROLET							
Nova 4.1	86-88	AKE	TP.A-005	15,0			
Nova 4.1	88-	AKE	TP.A-005	15,0			
Nova 5.0	88-	AKE	TP.A-005	15,0			
Nova 5.7	88-	AKE	TP.A-005	15,0			
Nova 5.7	86-88	AKE	TP.A-005	15,0			
Corsa Pick-Up 1,0	08/97 – 07/02	ATE	TP.A-038	16,5			
Corsa Pick-Up 1,4 GLS	08/94 – 07/97	ATE	TP.A-038	16,5			
Lanos Sedan 1,4	11/05 –	ATE	TP.A-038	16,5			
Lanos Sedan 1,6 16V	11/05 –	ATE	TP.A-017	18,0			
Matiz 0,8 (M200, M250)	03/05 –	AK	TP.A-088	16,7			
Matiz 0,8 LPG (M200, M250)	03/05 –	AK	TP.A-088	16,7			
Matiz 1,0 (M200, M250)	03/05 –	AK	TP.A-088	16,7			
Matiz 1,0 LPG (M200, M250)	03/05 –	AK	TP.A-088	16,7			
Spark 0,8	05/05 –	AK	TP.A-088	16,7			
Spark 0,8 (M200, M250)	03/05 –	AK	TP.A-088	16,7			
Spark 0,8 LPG (M200, M250)	03/05 –	AK	TP.A-088	16,7			
Spark 1,0 (M200, M250)	03/05 –	AK	TP.A-088	16,7			
Spark 1,0 LPG (M200, M250)	03/05 –	AK	TP.A-088	16,7			
Spark 1,0 SX	05/05 –	AK	TP.A-088	16,7			
Vectra 2,2	05/98 – 12/05				ATE	TP.A-010	15,5
CITROEN							
AX 11i	89-96	BDX	TP.A-011	18,0			
AX 14 GT	88-96	BDX	TP.A-011	18,0			
AX 14i	90-96	BDX	TP.A-011	18,0			
AX 14 Diesel	88-96	BDX	TP.A-011	18,0			
AX 15 D	94-	BDX	TP.A-011	18,0			
BX 11	86-88	BDX	TP.A-067	18,0			
BX 11 (TU Eng)	88-92	BDX	TP.A-067	18,0			
BX 14	83-88	BDX	TP.A-067	18,0			
BX 14 Break	85-92	BDX	TP.A-067	18,0			
BX 14E, RE	83-88	BDX	TP.A-067	18,0			
BX 14 RE Classic	89-93	BDX	TP.A-067	18,0			
BX 14i	88-91	BDX	TP.A-067	18,0			
BX 14i Break	88-92	BDX	TP.A-067	18,0			
BX 15	84-92	BDX	TP.A-067	18,0			

Марка автомобиля	Годы выпуска автомобиля	Передние колодки			Задние колодки		
		Тип тормозной системы	№ по каталогу	Толщина изделия, мм	Тип тормозной системы	№ по каталогу	Толщина изделия, мм
CITROEN							
BX 16 Break RE, TRE	88-89	BDX	TP.A-067	18,0			
BX 16 Break RS	83-93	BDX	TP.A-067	18,0			
BX 16 RE, TRE	88-89	BDX	TP.A-067	18,0			
BX 16 RS, TRS	83-93	BDX	TP.A-067	18,0			
BX 16 TGі Classic, TZi Tecnic	89-93	BDX	TP.A-067	18,0			
BX 16 Break TGі Classic	89-94	BDX	TP.A-067	18,0			
BX 16 TRi	86-88	BDX	TP.A-067	18,0			
BX 16 Break TRi	85-88	BDX	TP.A-067	18,0			
BX 16i	86-93	BDX	TP.A-067	18,0			
BX 17 D	85-93	BDX	TP.A-067	18,0			
BX 17 Break D	85-93	BDX	TP.A-067	18,0			
BX 18 Break Turbo Diesel TRD	88-94	BDX	TP.A-067	18,0			
BX 19 Break Tecnic 4WD	89-93	BDX	TP.A-067	18,0			
BX 19 Break Diesel RD	85-92	BDX	TP.A-067	18,0			
BX 19 Break TGD Classic Diesel	92-93	BDX	TP.A-067	18,0			
BX 19 TRi, TZi	88-92	BDX	TP.A-067	18,0			
BX 19 TOP	92-	BDX	TP.A-067	18,0			
BX 19 TRS	88-89	BDX	TP.A-067	18,0			
BX 19 TRS, GT	84-88	BDX	TP.A-067	18,0			
BX 19 4WD	89-93	BDX	TP.A-067	18,0			
BX 19 TRi, GTi	88-92	BDX	TP.A-067	18,0			
BX 19 GTi	86-88	BDX	TP.A-067	18,0			
BX 19 GTi	92-93	BDX	TP.A-067	18,0			
BX 19 GTi 4WD	89-93	BDX	TP.A-067	18,0			
BX 19 16V GT, GTi	88-92	BDX	TP.A-067	18,0			
BX 19 16V GTi	92-93	BDX	TP.A-067	18,0			
BX 19 GTi 16V	87-88	BDX	TP.A-067	18,0			
BX 19 Diesel RD, TRD	83-92	BDX	TP.A-067	18,0			
BX 19 TGD Classic, TZD Tecnic	92-93	BDX	TP.A-067	18,0			
BX 19 Diesel RD, TRD	87-93	BDX	TP.A-067	18,0			
BX 19 TZD Tecnic Auto	92-93	BDX	TP.A-067	18,0			
BX 19 Turbodiesel TRD	88-91	BDX	TP.A-067	18,0			
BX Break (XB-_) 15	10/87 – 05/92	BDX	TP.A-067	18,0			
BX Break (XB-_) 19 4x4	06/89 – 05/91	BDX	TP.A-067	18,0			
BX Break (XB-_) 19 KAT	07/86 – 12/94	BDX	TP.A-067	18,0			
BX Entreprise 14	85-88	BDX	TP.A-067	18,0			
BX Entreprise 16	85-93	BDX	TP.A-067	18,0			
BX Entreprise 19 D	85-93	BDX	TP.A-067	18,0			
Berlingo (MF) 1,1i -11/02	07/96-	BO	TP.A-095	18,8			
Berlingo (MF) 1,4 Ø245,0 mm	11/02-	BO	TP.A-095	18,8			
Berlingo (MF) 1,4 Ø266,0 mm	11/02-	BO	TP.A-095	18,8			
Berlingo (MF) 1,4 Bivalent Ø266,0 mm	11/02-	BO	TP.A-095	18,8			
Berlingo (MF) 1,4 Bivalent Ø283,0 mm	11/02-	BO	TP.A-095	18,8			
Berlingo (MF) 1,4 GNC Ø245,0 mm	11/02-	BO	TP.A-095	18,8			
Berlingo (MF) 1,4 GNC Ø266,0 mm	11/02-	BO	TP.A-095	18,8			
Berlingo (MF) 1,4i	07/96-	BO	TP.A-095	18,8			

Марка автомобиля	Годы выпуска автомобиля	Передние колодки			Задние колодки		
		Тип тормозной системы	№ по каталогу	Толщина изделия, мм	Тип тормозной системы	№ по каталогу	Толщина изделия, мм
CITROEN							
Berlingo (MF) 1,4i Bivalent	04/03-	BO	TP.A-095	18,8			
Berlingo (MF) 1,6 ESP (-)	11/02-	BO	TP.A-095	18,8			
Berlingo (MF) Electric	01/98 –	BO	TP.A-095	18,8			
Berlingo (MF) Electric	01/00 –	BO	TP.A-095	18,8			
Berlingo (MF) 1,6 16V	10/00-	BO	TP.A-095	18,8			
Berlingo (MF) 1,6 HDI 75,90	07/05-	BO	TP.A-095	18,8			
Berlingo (MF) 1,6 HDI 110 ESP (-)	07/05-	BO	TP.A-095	18,8			
Berlingo (MF) 1,9D	07/96-	BO	TP.A-095	18,8			
Berlingo (MF) 1,9D 11/02-10/02	07/96-	BO	TP.A-095	18,8			
Berlingo (MF) 1,9D 4WD 11/02-10/02	07/98-	BO	TP.A-095	18,8			
Berlingo (MF) 2,0 HDi ESP (-)	11/02-10/05	BO	TP.A-095	18,8			
Berlingo (MF) 2,0 HDI 90	12/99	BO	TP.A-095	18,8			
Berlingo (MF) 1,9 HDi 4x4	11/02-10/05	BO	TP.A-095	18,8			
Berlingo Box 1,6 HDi 110 ESP (-)	04/08-	BO	TP.A-095	18,8			
Berlingo Box (M_) 1,1i 11/02-10/02	07/96-	BO	TP.A-095	18,8			
Berlingo Box (M_) 1,4	11/02-	BO	TP.A-095	18,8			
Berlingo Box (M_) 1,4 Bivalent, Ø266,0 mm	11/02-	BO	TP.A-095	18,8			
Berlingo Box (M_) 1,4 Bivalent, Ø283,0 mm	11/02-	BO	TP.A-095	18,8			
Berlingo Box (M_) 1,4i 11/02-10/02	07/96-	BO	TP.A-095	18,8			
Berlingo Box (M_) 1,4i Bivalent	04/03-	BO	TP.A-095	18,8			
Berlingo Box (M_) 1,6 16V	10/00-	BO	TP.A-095	18,8			
Berlingo Box (M_) 1,6 HDI 75, 05/06-	07/05-	BO	TP.A-095	18,8			
Berlingo Box (M_) 1,6 HDI 90, ESP(-)	07/05-	BO	TP.A-095	18,8			
Berlingo Box (M_) 1,9D	07/96-	BO	TP.A-095	18,8			
Berlingo Box (M_) 1,9 D70	04/99-	BO	TP.A-095	18,8			
Berlingo Box (M_) 1,9 D70 4WD, 11/01-10/02	07/98-	BO	TP.A-095	18,8			
Berlingo Box (M_) 2,0 HDI -10/02	12/99-	BO	TP.A-095	18,8			
Berlingo Box (M_) 2,0 HDI 11/02-, ESP(-)	12/99-	BO	TP.A-095	18,8			
Berlingo Box (M_) 2,0 HDI 90 4WD	11/00-	BO	TP.A-095	18,8			
C2 (JM_) 1,4 16V	06/06 –				GIR	TP.A-014	17,4
C2 (JM_) 1,6 06/06-, Ch. 10801→	09/03-	BO	TP.A-095	18,8			
C2 (JM_) 1,6 VTS	01/05-	BO	TP.A-095	18,8			
C2 (JM_) 1,6 HDi	09/05-	BO	TP.A-095	18,8			
C3 (FC_) 1,4 16V	12/03 –	BO	TP.A-095	18,8			
C3 (FC_) 1,6 16V	02/02 –	BO	TP.A-095	18,8			
C3 (FC_) 1,6 16V HDi	10/05 –	BO	TP.A-095	18,8			
C4 (LC_) 1,4 16V 06/07-, Ch. 11193→	11/04	BO	TP.A-095	18,8			
C4 (LC_) 1,6 16V 06/07-, Ch. 11193→	11/04	BO	TP.A-095	18,8			
C4 (LC_) 1,6 16V Bio-Flex -07/08, Ch. 11193→	07/07	BO	TP.A-095	18,8			
C4 (LC_) 1,6 VTi 120 MTM	07/08-	BO	TP.A-095	18,8			
C4 (LC_) 1,6 HDi 06/07-, Ch. 11193→	11/04	BO	TP.A-095	18,8			
C4 Coupe (LA_) 1,4 16V 06/07-, Ch. 11193→	11/04	BO	TP.A-095	18,8			

Марка автомобиля	Годы выпуска автомобиля	Передние колодки			Задние колодки		
		Тип тормозной системы	№ по каталогу	Толщина изделия, мм	Тип тормозной системы	№ по каталогу	Толщина изделия, мм
CITROEN							
C4 Coupe (LA_) 1,4 VTi 120 MTM	07/08-	BO	TP.A-095	18,8			
C4 Coupe (LA_) 1,6 VTi 120	07/08 –	BO	TP.A-095	18,8			
C4 Coupe (LA_) 1,6 HDi 06/07-, Ch. 11193→	11/04-	BO	TP.A-095	18,8			
C4 (LC_) 1,4 16V 10/05-05/07, Ch. 10551→11192	11/04	BO	TP.A-095	18,8			
C4 (LC_) 1,6 16V 10/05-05/07, Ch. 10551→11192	11/04	BO	TP.A-095	18,8			
C4 (LC_) 1,6 HDi 10/05-05/07, Ch. 10551→11192	11/04	BO	TP.A-095	18,8			
C4 Coupe (LA_) 1,4 16V EDS(-)	11/04-	BO	TP.A-095	18,8			
C4 Coupe (LA_) 1,6 16V 10/05-05/07, Ch. 10551→11192	11/04	BO	TP.A-095	18,8			
C4 Coupe (LA_) 1,6 HDi 10/05-05/07, Ch. 10551→11192	11/04	BO	TP.A-095	18,8			
C15 (VD_) 1,1	10/84 – 12/96	BDX	TP.A-011	18,0			
C15 (VD_) 1,1i	07/88 – 12/96	BDX	TP.A-011	18,0			
C15 (VD_) 1,4	07/87 – 12/96	BDX	TP.A-011	18,0			
C15 (VD_) 1,4 E	05/87 – 12/96	BDX	TP.A-011	18,0			
C15 (VD_) 1,4i	05/91 – 12/96	BDX	TP.A-011	18,0			
C15 (VD_) 1,9 D	12/00 – 12/05	BDX	TP.A-011	18,0			
C15 Estate 1,1	08/88 – 07/96	BDX	TP.A-011	18,0			
C15 Estate 1,4	05/87 – 07/96	BDX	TP.A-011	18,0			
C-Crosser (EP_) 2,0	11/10 –	AKE	TP.A-063	15,7			
C-Crosser (EP_) 2,2 HDi	02/07 –	AKE	TP.A-063	15,7			
C-Crosser (EP_) 2,4 16V	08/08 –	AKE	TP.A-063	15,7			
C-Crosser Enterprise 2,4 16V	01/09 –	AKE	TP.A-063	15,7			
Jumper Box (230L) 2,0 02/02-, Ø280,0 mm	03/94-04/02	BR	TP.A-100	19,0			
Jumper Box (230L) 2,0 02/02-, Ø300,0 mm	03/94-04/02	BR	TP.A-100	19,0			
Jumper Box (230L) 2,0 HDi Ø280,0 mm	11/01-04/02	BR	TP.A-100	19,0			
Jumper Box (230L) 2,0 HDi Ø300,0 mm	11/01-04/02	BR	TP.A-100	19,0			
Jumper Box (230L) 2,8 HDi 02/02-, Ø280,0 mm	09/00-04/02	BR	TP.A-100	19,0			
Jumper Box (230L) 2,8 HDi 02/02-, Ø300,0 mm	09/00-04/02	BR	TP.A-100	19,0			
Jumper Box (230L) 2,8 HDi 4x4 02/02-, Ø280,0 mm	09/00-04/02	BR	TP.A-100	19,0			
Jumper Box (230L) 2,8 HDi 4x4 02/02-, Ø300,0 mm	09/00-04/02	BR	TP.A-100	19,0			
Jumper Box (244) 2,0 Ø280,0 mm	04/02-	BR	TP.A-100	19,0			
Jumper Box (244) 2,0 Ø300,0 mm	04/02-	BR	TP.A-100	19,0			
Jumper Box (244) 2,0 Bivalent, Ø280,0 mm	02/03-	BR	TP.A-100	19,0			

Марка автомобиля	Годы выпуска автомобиля	Передние колодки			Задние колодки		
		Тип тормозной системы	№ по каталогу	Толщина изделия, мм	Тип тормозной системы	№ по каталогу	Толщина изделия, мм
CITROEN							
Jumper Box (244) 2,0 Bivalent, Ø300,0 mm	02/03-	BR	TP.A-100	19,0			
Jumper Box (244) 2,0 HDi Ø280,0 mm	04/02-	BR	TP.A-100	19,0			
Jumper Box (244) 2,0 HDi Ø300,0 mm	04/02-	BR	TP.A-100	19,0			
Jumper Box (244) 2,2 HDi Ø280,0 mm	04/02-	BR	TP.A-100	19,0			
Jumper Box (244) 2,2 HDi Ø300,0 mm	04/02-	BR	TP.A-100	19,0			
Jumper Box (244) 2,8 HDi -06/06, Ø280,0 mm	04/02-	BR	TP.A-100	19,0			
Jumper Box (244) 2,8 HDi -06/06, Ø300,0 mm	04/02-	BR	TP.A-100	19,0			
Jumper Box (244) 2,8 HDi Ø280,0 mm	04/02-	BR	TP.A-100	19,0			
Jumper Box (244) 2,8 HDi Ø300,0 mm	04/02-	BR	TP.A-100	19,0			
Jumper Box (244) 2,8 HDi 4x4 Ø280,0 mm	04/02-	BR	TP.A-100	19,0			
Jumper Box (244) 2,8 HDi 4x4 Ø300,0 mm	04/02-	BR	TP.A-100	19,0			
Jumper Bus (230P) 2,0 02/02-, Ø280,0 mm	02/94-04/02	BR	TP.A-100	19,0			
Jumper Bus (230P) 2,0 02/02-, Ø300,0 mm	02/94-04/02	BR	TP.A-100	19,0			
Jumper Bus (230P) 2,8 HDi 4x4, 02/02-, Ø280,0 mm	09/00-04/02	BR	TP.A-100	19,0			
Jumper Bus (230P) 2,8 HDi 4x4, 02/02-, Ø300,0 mm	09/00-04/02	BR	TP.A-100	19,0			
Jumper Bus (244, Z_) 2,0 Ø280,0 mm	04/02-	BR	TP.A-100	19,0			
Jumper Bus (244, Z_) 2,0 Ø300,0 mm	04/02-	BR	TP.A-100	19,0			
Jumper Bus (244, Z_) 2,0 Bivalent, Ø280,0 mm	02/03-	BR	TP.A-100	19,0			
Jumper Bus (244, Z_) 2,0 Bivalent, Ø300,0 mm	02/03-	BR	TP.A-100	19,0			
Jumper Bus (244, Z_) 2,0 HDi, Ø280,0 mm	04/02-	BR	TP.A-100	19,0			
Jumper Bus (244, Z_) 2,0 HDi, Ø300,0 mm	04/02-	BR	TP.A-100	19,0			
Jumper Bus (244, Z_) 2,2 HDi, Ø280,0 mm	04/02-	BR	TP.A-100	19,0			
Jumper Bus (244, Z_) 2,2 HDi, Ø300,0 mm	04/02-	BR	TP.A-100	19,0			
Jumper Bus (244, Z_) 2,8 HDi, Ø280,0 mm	04/02-	BR	TP.A-100	19,0			
Jumper Bus (244, Z_) 2,8 HDi, Ø300,0 mm	04/02-	BR	TP.A-100	19,0			
Jumper Flatbed/Classis (230) 2,0 02/02-, Ø280,0 mm	03/94-04/02	BR	TP.A-100	19,0			
Jumper Flatbed/Classis (230) 2,0 02/02-, Ø300,0 mm	03/94-04/02	BR	TP.A-100	19,0			
Jumper Flatbed/Classis (230) 2,8 HDi, 02/02-, Ø280,0 mm	09/00-04/02	BR	TP.A-100	19,0			
Jumper Flatbed/Classis (230) 2,8 HDi, 02/02-, Ø300,0 mm	09/00-04/02	BR	TP.A-100	19,0			
Jumper Flatbed/Classis (244) 2,0 HDi, 06/06-, Ø280,0 mm	04/02-	BR	TP.A-100	19,0			
Jumper Flatbed/Classis (244) 2,0 HDi, 06/06-, Ø300,0 mm	04/02-	BR	TP.A-100	19,0			
Jumper Flatbed/Classis (244) 2,2 HDi, 06/06-, Ø280,0 mm	02/02-06/06	BR	TP.A-100	19,0			

Марка автомобиля	Годы выпуска автомобиля	Передние колодки			Задние колодки		
		Тип тормозной системы	№ по каталогу	Толщина изделия, мм	Тип тормозной системы	№ по каталогу	Толщина изделия, мм
CITROEN							
Jumper Flatbed/Classis (244) 2,2 HDi, 06/06-, Ø300,0 mm	0202-0606	BR	TP.A-100	19,0			
Jumper Flatbed/Classis (244) 2,2 HDi, 16V, Ø280,0 mm	04/02-	BR	TP.A-100	19,0			
Jumper Flatbed/Classis (244) 2,2 HDi, 16V, Ø300,0 mm	04/02-	BR	TP.A-100	19,0			
Jumper Flatbed/Classis (244) 2,8 HDi, 06/06-, Ø280,0 mm	04/02-	BR	TP.A-100	19,0			
Jumper Flatbed/Classis (244) 2,8 HDi, 06/06-, Ø300,0 mm	04/02-	BR	TP.A-100	19,0			
Jumper Flatbed/Classis (244) 2,8 HDi, Ø280,0 mm	04/02-	BR	TP.A-100	19,0			
Jumper Flatbed/Classis (244) 2,8 HDi, Ø300,0 mm	04/02-	BR	TP.A-100	19,0			
LN 0,6	77-79	BDX	TP.A-033	15,0			
LNA 0,6	78-85	BDX	TP.A-033	15,0			
Relay Box (230L) 2,0 HDi	11/01 – 04/02	BR	TP.A-100	19,0			
Relay Box (230L) 2,8 D	01/99 – 02/02	BR	TP.A-100	19,0			
Relay Box (230L) 2,8 HDi (HDi 4x4)	09/00 – 04/02	BR	TP.A-100	19,0			
Relay Box (244) 2,0	04/02 –	BR	TP.A-100	19,0			
Relay Box (244) 2,0 Bivalent	02/03 –	BR	TP.A-100	19,0			
Relay Box (244) 2,0 HDi	04/02 –	BR	TP.A-100	19,0			
Relay Box (244) 2,2 HDi	04/02 –	BR	TP.A-100	19,0			
Relay Box (244) 2,8 HDi (HDi 4x4)	04/02 –	BR	TP.A-100	19,0			
Relay Bus (230P) 2,8 D	01/99 – 02/02	BR	TP.A-100	19,0			
Relay Bus (230P) 2,8 HDi 4x4	09/00 – 04/02	BR	TP.A-100	19,0			
Relay Bus (244) 2,0	04/02 –	BR	TP.A-100	19,0			
Relay Bus (244) 2,0 Bivalent	02/03 –	BR	TP.A-100	19,0			
Relay Bus (244) 2,0 HDi	04/02 –	BR	TP.A-100	19,0			
Relay Bus (244) 2,2 HDi	04/02 –	BR	TP.A-100	19,0			
Relay Bus (244) 2,8 HDi	04/02 –	BR	TP.A-100	19,0			
Relay Flatbed / Chassis (230) 2,0	03/94 – 04/02	BR	TP.A-100	19,0			
Relay Flatbed / Chassis (230) 2,8 D	01/99 – 02/02	BR	TP.A-100	19,0			
Relay Flatbed / Chassis (230) 2,8 HDi	09/00 – 04/02	BR	TP.A-100	19,0			
Relay Flatbed / Chassis (244) 2,0 HDi	04/02 –	BR	TP.A-100	19,0			
Relay Flatbed / Chassis (244) 2,2 HDi (16V)	02/02 – 06/06	BR	TP.A-100	19,0			
Relay Flatbed / Chassis (244) 2,8 HDi (HDi 4x4)	02/02 –	BR	TP.A-100	19,0			
Saxo 1,0 i	96-	BDX	TP.A-011	18,0			
Saxo 1,1 i	96-	BDX	TP.A-011	18,0			
Saxo 1,4 i	96-	BDX	TP.A-011	18,0			
Saxo 1,5 Diesel	96-	BDX	TP.A-011	18,0			

Марка автомобиля	Годы выпуска автомобиля	Передние колодки			Задние колодки		
		Тип тормозной системы	№ по каталогу	Толщина изделия, мм	Тип тормозной системы	№ по каталогу	Толщина изделия, мм
CITROEN							
Saxo (S0, S1) 1,6	02/96 – 04/04	BDX	TP.A-011	18,0	BDX	TP.A-067	11,0
Saxo (S0, S1) 1,6 VTL, VTR, VTS	05/96 – 09/03	BDX	TP.A-011	18,0	BDX	TP.A-067	11,0
Visa 0,6 Club	80-88	BDX	TP.A-033	14,0			
Visa 0,6 Special	79-81	BDX	TP.A-033	14,0			
Visa 1,1 Cabrio Plein Air	83-	BDX	TP.A-033	14,0			
XSARA Picasso (N68) 1,6 ESP(-)	12/99-	BO	TP.A-095	18,8			
XSARA Picasso (N68) 1,6 16V, ESP(-)	09/05-	BO	TP.A-095	18,8			
XSARA Picasso (N68) 1,6 Chrono, ESP(-)	04/01-10/04	BO	TP.A-095	18,8			
XSARA Picasso (N68) 1,6 HDi, ESP(-)	05/04-	BO	TP.A-095	18,8			
XSARA Picasso (N68) 1,8 16V, ESP(-)	02/00-	BO	TP.A-095	18,8			
XSARA Picasso (N68) 1,8 SX, ESP(-)	06/00-08/05	BO	TP.A-095	18,8			
XSARA Picasso (N68) 2,0 16V, ESP(-)	01/03-	BO	TP.A-095	18,8			
XSARA Picasso (N68) 2,0 HDi, ESP(-)	12/99-	BO	TP.A-095	18,8			
XSARA (N1) 1,4i	04/97 – 03/05	BO	TP.A-103	18,0			
XSARA (N1) 1,5 D	04/97 – 09/00	BO	TP.A-103	18,0			
XSARA (N1) 1,6 16V	09/00 – 03/05				BDX	TP.A-067	11,0
XSARA (N1) 1,6i	04/97 – 09/00				BDX	TP.A-067	11,0
XSARA (N1) 1,8i 16V (i Aut)	04/97 – 09/00				BDX	TP.A-067	11,0
XSARA (N1) 2,0 16V	04/97 – 03/05				BDX	TP.A-067	11,0
XSARA (N1) 2,0 HDi (90, 109)	02/99 – 03/05				BDX	TP.A-067	11,0
XSARA Break (N2) 1,4i	10/97 – 08/05				BDX	TP.A-067	11,0
XSARA Break (N2) 1,5 D	10/97 – 09/00	BO	TP.A-103	18,0			
XSARA Break (N2) 1,6 16V	09/00 – 08/05				BDX	TP.A-067	11,0
XSARA Break (N2) 1,6i	10/97 – 09/00				BDX	TP.A-067	11,0
XSARA Break (N2) 1,8i 16V (Aut)	10/97 – 09/00				BDX	TP.A-067	11,0
XSARA Break (N2) 1,9 TD	10/97 – 09/00				BDX	TP.A-067	11,0
XSARA Break (N2) 2,0 16V	07/98 – 08/05				BDX	TP.A-067	11,0
XSARA Break (N2) 2,0 HDi (90, 109)	02/99 – 08/05				BDX	TP.A-067	11,0
XSARA Coupe (N0) 1,4i	03/98 – 03/05	BO	TP.A-103	18,0			
XSARA Coupe (N0) 1,6 16V	09/00 – 03/05				BDX	TP.A-067	11,0
XSARA Coupe (N0) 1,6i	02/98 – 09/00				BDX	TP.A-067	11,0
XSARA Coupe (N0) 1,8i (16V)	02/98 – 09/00				BDX	TP.A-067	11,0

Марка автомобиля	Годы выпуска автомобиля	Передние колодки			Задние колодки		
		Тип тормозной системы	№ по каталогу	Толщина изделия, мм	Тип тормозной системы	№ по каталогу	Толщина изделия, мм
CITROEN							
XSARA Coupe (N0) 1,9 TD	02/98 – 09/00				BDX	TP.A-067	11,0
XSARA Coupe (N0) 2,0 16V	02/98 – 03/05				BDX	TP.A-067	11,0
XSARA Coupe (N0) 2,0 HDi (90, 109)	02/99 – 03/05				BDX	TP.A-067	11,0
XSARA Estate (N2) 1,4i	10/97 – 08/05				BDX	TP.A-067	11,0
XSARA Estate (N2) 1,5 D	10/97 – 09/00	BO	TP.A-103	18,0			
XSARA Estate (N2) 1,6 16V	09/00 – 08/05				BDX	TP.A-067	11,0
XSARA Estate (N2) 1,6i	10/97 – 09/00				BDX	TP.A-067	11,0
XSARA Estate (N2) 1,8i 16V (Aut)	10/97 – 09/00				BDX	TP.A-067	11,0
XSARA Estate (N2) 1,9 TD	10/97 – 09/00				BDX	TP.A-067	11,0
XSARA Estate (N2) 2,0 16V	07/98 – 08/05				BDX	TP.A-067	11,0
XSARA Estate (N2) 2,0 HDi (90, 109)	02/99 – 08/05				BDX	TP.A-067	11,0
ZX 1,1	91-	BDX	TP.A-011	18,0	BDX	TP.A-067	11,0
ZX 1,1 Reflex	91-	BDX	TP.A-011	18,0			
ZX 1,4	91-92	BDX	TP.A-011	18,0			
ZX 1,4i Avantage, Reflex	91-	BDX	TP.A-011	18,0	BDX	TP.A-067	11,0
ZX 1,4i Break	94-	BDX	TP.A-011	18,0			
ZX 1,6i Avantage	91-						
ZX 1,8i Aura Furio (16V)	93-97	BDX	TP.A-011	18,0	BDX	TP.A-067	11,0
ZX 1,9i Volkane	91-	BDX	TP.A-011	18,0	BDX	TP.A-067	11,0
ZX 2,0i Volance	92-				BDX	TP.A-067	11,0
ZX 2,0i 16V	93-				BDX	TP.A-067	11,0
ZX 1,9 D, Avantage, Reflex	92-	BDX	TP.A-011	18,0			
ZX 1,9 Turbo D	92-				BDX	TP.A-067	11,0
ZX Break (N2) 1,6i	10/93 – 10/97				BDX	TP.A-067	11,0
ZX Break (N2) 1,8 D	10/93 – 10/97	BDX	TP.A-011	18,0	BDX	TP.A-067	11,0
ZX Break (N2) 1,8i (16V)	10/93 – 02/98				BDX	TP.A-067	11,0
ZX Break (N2) 1,9 D / TD	10/93 – 10/97				BDX	TP.A-067	11,0
ZX Entreprise 1,1	93-	BDX	TP.A-011	18,0			
ZX Entreprise 1,4 i	91-	BDX	TP.A-011	18,0			
ZX Entreprise 1,8 D	94-	BDX	TP.A-011	18,0			
ZX Entreprise 1,9 D	93-	BDX	TP.A-011	18,0			
ZX Estate (N2) 1,6i	10/93 – 10/97				BDX	TP.A-067	11,0
ZX Estate (N2) 1,8 D	10/93 – 10/97	BDX	TP.A-011	18,0	BDX	TP.A-067	11,0

Марка автомобиля	Годы выпуска автомобиля	Передние колодки			Задние колодки		
		Тип тормозной системы	№ по каталогу	Толщина изделия, мм	Тип тормозной системы	№ по каталогу	Толщина изделия, мм
CITROEN							
ZX Estate (N2) 1,8i (16V)	10/93 – 02/98				BDX	TP.A-067	11,0
ZX Estate (N2) 1,9 D / TD	10/93 – 10/97				BDX	TP.A-067	11,0
DACIA							
Logan (LS_) 1,2 16V	02/06 –	TRW	TP.A-090	18,0			
Logan (LS_) 1,2 16V LPG	02/06 –	TRW	TP.A-090	18,0			
Logan (LS_) 1,4 (LSOA, LSOC, LSOE, LSOG)	09/04 –	TRW	TP.A-090	18,0			
Logan (LS_) 1,4 MPI LPG (LS0C)	02/06 –	TRW	TP.A-090	18,0			
Logan (LS_) 1,5 dCi (LS04, LS0W)	09/07 –	TRW	TP.A-090	18,0			
Logan (LS_) 1,6 (LSOB, LSOD, LSOE, LSOH)	09/04 –	TRW	TP.A-090	18,0			
Logan (LS_) 1,6 16V (LS0M)	02/06 –	TRW	TP.A-090	18,0			
Logan (LS_) 1,6 16V Flexi fuel	07/10 –	TRW	TP.A-090	18,0			
Logan (LS_) 1,6 BiFuel	05/10 –	TRW	TP.A-090	18,0			
Logan (LS_) 1,6 MPI 85	05/10 –	TRW	TP.A-090	18,0			
Logan Express 1,5 dCi (FS0K)	03/09 –	TRW	TP.A-090	18,0			
Logan MCV (KS_) 1,4	02/07 –	TRW	TP.A-090	18,0			
Logan MCV (KS_) 1,5 dCi (KS0K, KS0W)	02/07 –	TRW	TP.A-090	18,0			
Logan MCV (KS_) 1,5 dCi (KS04)	05/10 –	TRW	TP.A-090	18,0			
Logan MCV (KS_) 1,6	02/07 –	TRW	TP.A-090	18,0			
Logan MCV (KS_) 1,6 MPI 85	05/10 –	TRW	TP.A-090	18,0			
Sandero 1,2 16V	11/08 –	TRW	TP.A-090	18,0			
Sandero 1,2 16V LPG	11/08 –	TRW	TP.A-090	18,0			
Sandero 1,5 dCi	11/08 –	TRW	TP.A-090	18,0			
Sandero 1,6	06/08 –	TRW	TP.A-090	18,0			
Sandero 1,6 16V	07/11 –	TRW	TP.A-090	18,0			
Sandero 1,6 MPI 85	05/10 –	TRW	TP.A-090	18,0			
Sandero II 1,2 LPG	01/13 –	TRW	TP.A-090	18,0			
D.A.F.							
65 CF (181, 212, 241 л.с.)	1998 – 2000	KNORR SB 7000	TP.A-115	30,0	KNORR SB 7000	TP.A-115	30,0
75 CF (249, 288, 320 л.с.)	1998 – 2000	KNORR SB 7000	TP.A-115	30,0	KNORR SB 7000	TP.A-115	30,0
85 CF (340, 381, 428 л.с.)	1998 – 2000	KNORR SB 7000	TP.A-115	30,0	KNORR SB 7000	TP.A-115	30,0
95 XF (381, 428, 483, 530 л.с.)	1997 – 2002	KNORR SB 7000	TP.A-115	30,0	KNORR SB 7000	TP.A-115	30,0
400 Serie Van - 428-435 2,5 D	04/89 – 08/93	AP	TP.A-043	18,0			
400 Serie Van - 428-435 2,5 TD	04/89 – 08/93	AP	TP.A-043	18,0			
CF 65 (185, 220, 250 л.с.)	2001 –	KNORR SB 7000	TP.A-115	30,0	KNORR SB 7000	TP.A-115	30,0
CF 75 (249, 310, 360 л.с.)	2001 –	KNORR SB 7000	TP.A-115	30,0	KNORR SB 7000	TP.A-115	30,0

Марка автомобиля	Годы выпуска автомобиля	Передние колодки			Задние колодки		
		Тип тормозной системы	№ по каталогу	Толщина изделия, мм	Тип тормозной системы	№ по каталогу	Толщина изделия, мм
D.A.F.							
CF 85 (340, 381, 428, 483 л.с.)	2001 –	KNORR SB 7000	TP.A-115	30,0	KNORR SB 7000	TP.A-115	30,0
LF 55 (167, 185, 220, 250 л.с.)	2001 –	KNORR SB 7000	TP.A-115	30,0	KNORR SB 7000	TP.A-115	30,0
LF 55 (180, 224, 286 л.с.)	2006 –	KNORR SB 7000	TP.A-115	30,0	KNORR SB 7000	TP.A-115	30,0
XF 95 (381, 428, 483, 530 л.с.)	2002 – 2006	KNORR SB 7000	TP.A-115	30,0	KNORR SB 7000	TP.A-115	30,0
XF 105 (408, 462, 510 л.с.)	2005 –	KNORR SB 7000	TP.A-115	30,0	KNORR SB 7000	TP.A-115	30,0
Shepra 250, 280 Combi	8/82-	AP	TP.A-043	18,0			
Shepra 285, 310	8/83-	AP	TP.A-043	18,0			
Shepra 350	83-85	AP	TP.A-043	18,0			
DAEWOO							
Aranos 1,8 CD, CDX	95-	ATE	TP.A-017	18,0			
Cielo (KLETN) 1,5	02/95 – 08/97	ATE	TP.A-038	16,5			
Cielo (KLETN) 1,5 16V	02/95 – 08/97	ATE	TP.A-017	18,0			
Cielo Sedan (KLETN) 1,5	02/95 – 08/97	ATE	TP.A-038	16,5			
Cielo Sedan (KLETN) 1,5 16V	02/95 – 08/97	ATE	TP.A-017	18,0			
Espero 1,5 All Models	95-	ATE	TP.A-017	18,0			
Espero 1,8 All Models	95-	ATE	TP.A-017	18,0			
Espero 2,0 All Models	95-	ATE	TP.A-017	18,0			
Lanos (KLAT) 1,4	05/97-	AK	TP.A-088	16,7			
Lanos (KLAT) 1,5	05/97-	AK	TP.A-088	16,7			
Lanos (KLAT) 1,6 16V	05/97-	AK	TP.A-088	16,7			
Lanos Saloon 1,4 (KLAT)	05/97-	AK	TP.A-088	16,7			
Lanos Saloon 1,5 (KLAT)	05/97-	AK	TP.A-088	16,7			
Lanos Saloon 1,6 16V (KLAT)	05/97-	AK	TP.A-088	16,7			
Matiz 0,8	09/98-	AK	TP.A-088	16,7			
Matiz 1,0	01/03-	AK	TP.A-088	16,7			
Matiz Box (KLA4)	08/98-	AK	TP.A-088	16,7			
Matiz 0,8	03/05	AK	TP.A-088	16,7			
Matiz 1,0	03/05-	AK	TP.A-088	16,7			
Nexia 1,5 GL, GLE	95-	ATE	TP.A-038	16,5			
Nexia 1,5 GTX, GLX	95-	ATE	TP.A-038	16,5			
Nexia 1,5 16V GLX, Sedan, GTX	95-	ATE	TP.A-038	16,5			
Nexia (KLETN) 1,5 16V	02/95 – 08/97	ATE	TP.A-017	18,0			
Nexia Sedan (KLETN) 1,5 16V	02/95 – 08/97	ATE	TP.A-017	18,0			
Polonez Atu 1,6 Gli	91-	GIR	TP.A-012	17,0			

Марка автомобиля	Годы выпуска автомобиля	Передние колодки			Задние колодки		
		Тип тормозной системы	№ по каталогу	Толщина изделия, мм	Тип тормозной системы	№ по каталогу	Толщина изделия, мм
DAIMLER							
Daimler XJ (X30_) Six 4,0	10/94 – 06/03	ATE	TP.A-061	17,5			
Daimler XJ 40, 81 Sovereign 4,0	09/89 – 09/94	ATE	TP.A-061	17,5			
Daimler XJ 40, 81 Sedan Sovereign 4,0	09/89 – 09/94	ATE	TP.A-061	17,5			
DENNIS							
Olympus (260 л.с.)	2009 –	KNORR SB 7000	TP.A-115	30,0	KNORR SB 7000	TP.A-115	30,0
Olympus (301 л.с.)	2009 –	KNORR SB 7000	TP.A-115	30,0	KNORR SB 7000	TP.A-115	30,0
EAGLE							
Talon 2,0: Tsi/TS; 4ND	93-	AKE	TP.A 063	15,7			
Summit 1,5 4 cyl Coupe	93-	SUM	TP.A 054	15,0			
Summit 1,8 4 cyl Break	93-	SUM	TP.A 054	15,0			
Summit 2,3 4 cyl Break	93-	SUM	TP.A 054	15,0			
FIAT							
147 1,0	10/76 – 12/95	BDX	TP.A-033	18,0	GIR	TP.A-007	16,4
Croma 2,0 CHT (ABS)	85-				GIR	TP.A-007	16,4
Croma 2,0i i.e S, SL (ABS)	87-88				GIR	TP.A-007	16,4
Croma 2,0i Turbo i.e (ABS)	87-88				GIR	TP.A-007	16,4
Croma 2,0 i.e Turbo Super (ABS)	83-				GIR	TP.A-007	16,4
Croma 2,0 i.e Turbo Super, E (ABS)	85-				GIR	TP.A-007	16,4
Croma 2,0 i.e Turbo Super, S, SL (ABS)	85-				GIR	TP.A-007	16,4
Croma 2,5 D Turbo (ABS)	85-				GIR	TP.A-007	16,4
Croma 1,9i D, Super D	85-				GIR	TP.A-007	16,4
Croma 1,9i D, TD, DS, ID (ABS)	85-				GIR	TP.A-007	16,4
Croma 2,4 D Turbo (ABS)	85-				GIR	TP.A-007	16,4
Croma 2,5 D TD Super (ABS)	83-				GIR	TP.A-007	16,4
Daily 40 2,4 All Models	83-87	PER	TP.A-034	18,0			
Daily 45 45 10 All Models	86-	PER	TP.A-034	18,0			
Daily 49 49 10 All Models	86-	PER	TP.A-034	18,0			
Daily 65 65 12 Turbo All Models	86-	PER	TP.A-034	18,0			
Daily 79 79 10 All Models	86-	PER	TP.A-034	18,0			
Daily 79 79 12 Turbo All Models	86-	PER	TP.A-034	18,0			
Daily 79 79 13 All Models	86-	PER	TP.A-034	18,0			
Daily 79 79 14 All Models	86-	PER	TP.A-034	18,0			
Ducato Box (230L) 2,8 JTD 12/01-, 18	1100-0402	BR	TP.A-100	19,0			
Ducato Box (230L) 2,8 JTD 4x4, 12/01-, 18	1100-0402	BR	TP.A-100	19,0			
Ducato Box (230L) 2,8 TDI 09/01-11/01, 18	1097-0402	BR	TP.A-100	19,0			
Ducato Box (230L) 2,8 TDI 4x4, 09/01-11/01, 18	0699-0402	BR	TP.A-100	19,0			
Ducato Box (244) 2,0 18	04/02-	BR	TP.A-100	19,0			
Ducato Box (244) 2,0 4x4 ST	0502-0706	BR	TP.A-100	19,0			

Марка автомобиля	Годы выпуска автомобиля	Передние колодки			Задние колодки		
		Тип тормозной системы	№ по каталогу	Толщина изделия, мм	Тип тормозной системы	№ по каталогу	Толщина изделия, мм
FIAT							
Ducato Box (244) 2,0 Bipower, 18	11/02-	BR	TP.A-100	19,0			
Ducato Box (244) 2,3 JTD, 18	04/02-	BR	TP.A-100	19,0			
Ducato Box (244) 2,8 JTD	04/02-	BR	TP.A-100	19,0			
Ducato Box (244) 2,8 JTD 4x4, 18	07/02-	BR	TP.A-100	19,0			
Ducato Box (244) 2,8 JTD Power, 18	05/04-	BR	TP.A-100	19,0			
Ducato Box (244) 2,8 TD 18, ST	11/03-07/06	BR	TP.A-100	19,0			
Ducato Box (244) 2,8 TD 4x4, 18, ST	11/03-07/06	BR	TP.A-100	19,0			
Ducato Bus (230) 2,0 Panorama/Combinato, 09/01-, 18	03/94-04/02	BR	TP.A-100	19,0			
Ducato Bus (230) 2,8 09/01-, 18	02/98-04/02	BR	TP.A-100	19,0			
Ducato Bus (230) 2,8 JTD 11/01-	11/00-04/02	BR	TP.A-100	19,0			
Ducato Bus (230) 2,8 JTD 4x4. 12/01-, 18	11/00-04/02	BR	TP.A-100	19,0			
Ducato Bus (230) 2,8 TDI 09/01-11/01, 18	10/97-04/02	BR	TP.A-100	19,0			
Ducato Bus (230) 2,8 TDI 4x4, 09/01-11/01, 18	07/99-04/02	BR	TP.A-100	19,0			
Ducato Bus (244, Z_) 2,0 18	04/02-	BR	TP.A-100	19,0			
Ducato Bus (244, Z_) 2,0 4x4	05/02-07/06	BR	TP.A-100	19,0			
Ducato Bus (244, Z_) 2,0 Bipower, 18	11/02-	BR	TP.A-100	19,0			
Ducato Bus (244, Z_) 2,3 JTD, 18	04/02-	BR	TP.A-100	19,0			
Ducato Bus (244, Z_) 2,8 JTD, 18, Ø280,0 mm	04/02	BR	TP.A-100	19,0			
Ducato Bus (244, Z_) 2,8 JTD, 18, Ø300,0 mm	04/02	BR	TP.A-100	19,0			
Ducato Bus (244, Z_) 2,8 JTD 4x4, 18	07/02-	BR	TP.A-100	19,0			
		BR	TP.A-100	19,0			
Ducato Flatbed/Classis (230) 2,8D, 09/01-11/01, 18	02/98-04/02	BR	TP.A-100	19,0			
Ducato Flatbed/Classis (230) 2,8 JTD, 12/01, 18, Ø280,0 mm	11/00-04/02	BR	TP.A-100	19,0			
Ducato Flatbed/Classis (230) 2,8 JTD, 12/01, 18, Ø300,0 mm	11/00-04/02	BR	TP.A-100	19,0			
Ducato Flatbed/Classis (230) 2,8 TDI, 09/01-11/01, 18	12/98-04/02	BR	TP.A-100	19,0			
Ducato Flatbed/Classis (244) 2,3 JTD, 18	04/02-	BR	TP.A-100	19,0			
Ducato Flatbed/Classis (244) 2,8 JTD, 18	04/02-	BR	TP.A-100	19,0			
Ducato Flatbed/Classis (244) 2,8 JTD 4x4, 18, Ø280,0 mm	10/02-	BR	TP.A-100	19,0			
Ducato Flatbed/Classis (244) 2,8 JTD 4x4, 18, Ø300,0 mm	10/02-	BR	TP.A-100	19,0			
Ducato Flatbed/Classis (244) JTD Power, 18	05/04-	BR	TP.A-100	19,0			
Panda (141A_) 1000	01/85 – 12/92	GIR BDX	TP.A-012 TP.A-033	17,0 18,0			
Panda (141A_) 1000 4x4	01/86 – 12/94	GIR BDX	TP.A-012 TP.A-033	17,0 18,0			
Panda (141A_) 1000 i.e. KAT	10/87 – 08/98	GIR BDX	TP.A-012 TP.A-033	17,0 18,0			
Panda (141A_) 1100	05/91 – 09/03	GIR BDX	TP.A-012 TP.A-033	17,0 18,0			
Panda (141A_) 1100 4x4	02/95 – 07/04	GIR BDX	TP.A-012 TP.A-033	17,0 18,0			
Panda (141A_) 1100 Trekking 4x4	10/91 – 07/04	GIR BDX	TP.A-012 TP.A-033	17,0 18,0			

Марка автомобиля	Годы выпуска автомобиля	Передние колодки			Задние колодки		
		Тип тормозной системы	№ по каталогу	Толщина изделия, мм	Тип тормозной системы	№ по каталогу	Толщина изделия, мм
FIAT							
Panda (141A_) 1300 D	04/86 – 12/92	BDX	TP.A-033	18,0			
Panda (141A_) 650	01/82 – 07/04	BDX	TP.A-033	18,0			
Panda (141A_) 750 (141AA)	01/86 – 01/95	BDX	TP.A-033	18,0			
Panda (141A_) 750 (141AM) KAT	01/95 – 10/03	BDX	TP.A-033	18,0			
Panda (141A_) 900	10/80 – 12/96	BDX	TP.A-033	18,0			
Panda Box (141_) 1000 i.e.	08/92 – 02/04	GIR BDX	TP.A-012 TP.A-033	17,0 18,0			
Panda Box (141_) 750	01/86 – 07/92	BDX	TP.A-033	18,0			
Panda 0,6	81-85	BDX	TP.A-033	18,0			
Panda 0,7 Kombi	91-92	BDX	TP.A-033	18,0			
Panda 0,7	95-	BDX	TP.A-033	18,0			
Panda 0,8	81-91	BDX	TP.A-033	18,0			
Panda 0,9, CL, Super	81-92	BDX	TP.A-033	18,0			
Panda 0,9i, E	92-	BDX	TP.A-033	18,0			
Panda 1,0 All Models	86-91	BDX	TP.A-033	18,0			
Panda 1,1 All Models	86-95	BDX	TP.A-033	18,0			
Panda 0,9 CL SS Dance, SS Cafe	92-	BDX	TP.A-012	17,0			
Panda 1,0 CL Chris, Selecta, CLX	92-	BDX	TP.A-012	17,0			
Regata 60, 70, 75, 85 Super, 90 Super i.E, 100 Super i.E, 1,7 Diesel (Weekend)	85-89	BDX	TP.A-033	18,0			
Regata Sedan (138) (60, 65 Diesel; 70, 75, 80 Turbo Diesel, 85, 90 i.e., 100 Super) all models	09/83 – 12/90	BDX	TP.A-033	18,0			
Ritmo all models	85-87	BDX	TP.A-033	18,0			
Spazio 1,0	10/76 – 12/95	BDX	TP.A-033	18,0			
Strada I, II (138A) (55, 60, 65, 70, 75 i.e., 85, 90 i.e., 100, 105, 125, 130) all models	01/78 – 12/88	BDX	TP.A-033	18,0			
Talento 1,4	89-	GIR	TP.A-012	17,0			
Tempra 1,4i.e S, SX, L, Selecta (ABS)	90-	GIR	TP.A-012	17,0			
Tempra 1,6i.e S, SX, Liberty, SLX (ABS)	90-	GIR	TP.A-012	17,0			
Tempra 1,6i.e SX	90-	GIR	TP.A-012	17,0			
Tipo 1,1 DGT; Fire (ABS)	88-	GIR	TP.A-012	17,0			
Tipo 1,4i.e DGT,CL,AGT,SX,Selecta (ABS)	88-	GIR	TP.A-012	17,0			
Tipo 1,4i.e DGST, Selecta Estivale (ABS)	88-	GIR	TP.A-012	17,0			
Tipo 1,6i.e 16V DGT, AGT (ABS)	88-	GIR	TP.A-012	17,0			
Tipo 1,6i.e AGT, Super, DGT, SX (ABS)	88-	GIR	TP.A-012	17,0			
Tipo 1,8i.e 16 V GT (ABS)	92-	GIR	TP.A-012	17,0			
Tipo 1,9 Turbo DSX Sport, GT	88-	GIR	TP.A-012	17,0			
Tipo 1,7 D, DS	88-	GIR	TP.A-012	17,0			

Марка автомобиля	Годы выпуска автомобиля	Передние колодки			Задние колодки		
		Тип тормозной системы	№ по каталогу	Толщина изделия, мм	Тип тормозной системы	№ по каталогу	Толщина изделия, мм
FIAT							
Uno 1,3i Turbo S i.e (ABS)	83-	GIR	TP.A-012	17,0			
Uno 1,4i Turbo i.e Racing (ABS)	83-	GIR	TP.A-012	17,0			
Uno 1,5i 75 i.e SL, Selecta, SX	89-	GIR	TP.A-012	17,0			
Uno 45ES 0,9; Sting 0,9; Fire 1,0; 45Si.E 1,0	83-89	ATE	TP.A-033	18,0			
Uno 45iE; Van i.E	89-	ATE	TP.A-033	18,0			
Uno 50 all models	83-90	ATE	TP.A-033	18,0			
Uno 55 all models	01/83-	ATE	TP.A-033	18,0			
Uno 60; Super; C, L	85-92	ATE	TP.A-033	18,0			
Uno 70 all models (exc. Selecta)	83-92	ATE	TP.A-033	18,0			
Uno 75i.E; S; SL; SX; SiE; SXi; E	85-93	ATE	TP.A-033	18,0			
Uno 1,0i.E; 1,1i.E	92-	ATE	TP.A-033	18,0			
Uno 1,4i.E	91-	ATE	TP.A-033	18,0			
Uno 1,3 Diesel; Diesel Super	83-	ATE	TP.A-033	18,0			
Vivace 1,0	10/76 – 12/95	BDX	TP.A-033	18,0			
FORD							
Aspire 1,3 (USA)	93-	SUM	TP.A-058	15,0			
Capri 1,3 Coupe	78-81	GIR	TP.A-070	15,1			
Capri 1,6 Coupe	72-74	GIR	TP.A-070	15,1			
Capri 1,6 L, GL Coupe	74-80	GIR	TP.A-070	15,1			
Capri 1,6 L, GL, GT Coupe	79-85	GIR	TP.A-070	15,1			
Capri 2,0 L, GL, S, Chia Coupe	74-79	GIR	TP.A-070	15,1			
Capri 2,0 L, GL, S, Coupe	79-81	GIR	TP.A-070	15,1			
Capri 2,0 L, GL, GT, S, Coupe	79-85	GIR	TP.A-070	15,1			
Capri 2,3 S, Chia Coupe	74-79	GIR	TP.A-070	15,1			
Capri 2,3 Super GT, S, Chia Coupe	79-85	GIR	TP.A-070	15,1			
Capri 2,8 Injektion Coupe	81-84	GIR	TP.A-070	15,1			
Capri 2,8i Turbo Coupe	82-87	GIR	TP.A-070	15,1			
Capri 3,0 S, Chia Coupe	74-81	GIR	TP.A-070	15,1			
Cortina 1,3	70-79	GIR	TP.A-070	15,1			
Cortina 1,6	73-79	GIR	TP.A-070	15,1			
Cortina 2,0	70-82	GIR	TP.A-070	15,1			
Cortina 2,3	77-82	GIR	TP.A-070	15,1			
Cortina Turnier 1,3	70-73	GIR	TP.A-070	15,1			
Cortina Turnier 1,6	70-82	GIR	TP.A-070	15,1			
Cortina Turnier 2,0	70-82	GIR	TP.A-070	15,1			
Cortina Turnier 2,3	77-82	GIR	TP.A-070	15,1			
Courier Box (F3L, F5L) 1,3	09/91 – 02/96	ATE	TP.A-009	18,0			
Courier Box (F3L, F5L) 1,8 D	09/91 – 02/96	ATE	TP.A-009	18,0			
Escort 1,1 C, CL, Bravo, Laser	82-85	ATE	TP.A-009	18,0			
Escort 1,1 C, CL, Bravo, Laser (ABS)	85-88	ATE	TP.A-009	18,0			
Escort 1,1 C, CL, Bravo, Laser	86-90	ATE	TP.A-009	18,0			
Escort 1,1 L, CL	82-85	ATE	TP.A-009	18,0			
Escort 1,1 L, CL, Laser, Ghia, Turnier	82-85	ATE	TP.A-009	18,0			
Escort 1,1 (Fiesta Model)	9/90-	BEN	TP.A-057	18,6			
Escort 1,1 L, GL, Ghia	75-79	GIR	TP.A-070	15,1			

Марка автомобиля	Годы выпуска автомобиля	Передние колодки			Задние колодки		
		Тип тормозной системы	№ по каталогу	Толщина изделия, мм	Тип тормозной системы	№ по каталогу	Толщина изделия, мм
FORD							
Escort 1,3 C, CL, Bravo, Ghia	86-90	ATE	TP.A-009	18,0			
Escort 1,3 L, CL, Laser, Ghia, Turnier	80-85	ATE	TP.A-009	18,0			
Escort Turnier 1,3 C, CL	86-90	ATE	TP.A-009	18,0			
Escort Cabrio 1,3 Ghia	83-85	ATE	TP.A-009	18,0			
Escort 1,3 L, CL, Laser, Ghia, Turnier (ABS)	86-91	ATE	TP.A-009	18,0			
Escort 1,3 L, GL, Ghia	75-80	ATE	TP.A-070	15,1			
Escort 1,3i CLX Melody/CLX Clipper	93-	BEN	TP.A-057	18,6			
Escort 1,3 Delivery Van	9/90-	BEN	TP.A-057	18,6			
Escort 1,3 Koerier 55	3/91-	BEN	TP.A-057	18,6			
Escort 1,4 C, CL	80-85	ATE	TP.A-009	18,0			
Escort 1,4 C, CL, Bravo, Ghia	86-90	ATE	TP.A-009	18,0			
Escort 1,4 C, CL, Bravo, Ghia (ABS)	86-90	ATE	TP.A-009	18,0			
Escort 1,4 Cabrio Ghia	86-	ATE	TP.A-009	18,0			
Escort Turnier 1,4 C/CL/Ghia	86-90	ATE	TP.A-009	18,0			
Escort 1,4i Koerier 55	3/91-	BEN	TP.A-057	18,6			
Escort 1,4i Van Wagon	9/90-	BEN	TP.A-057	18,6			
Escort 1,4i C, CL, CLX, Ghia (ABS)	86-88	ATE	TP.A-009	18,0			
Escort 1,4i; C/CL/CLX/Ghia	91-12/94	BEN	TP.A-057	18,6			
Escort 1,4i; C Cabrio/L/LX/Laser	93-12/94	BEN	TP.A-057	18,6			
Escort 1,6 C, CL, Bravo, Ghia	86-90	ATE	TP.A-009	18,0			
Escort 1,6 C, Ghia GL	83-	ATE	TP.A-009	18,0			
Escort 1,6 Ghia	75-80	GIR	TP.A-070	15,1			
Escort 1,6 L, CL, Ghia, Laser	80-85	ATE	TP.A-009	18,0			
Escort 1,6 RS, Turbo	80-85	ATE	TP.A-009	18,0			
Escort 1,6 XR3	80-85	ATE	TP.A-009	18,0			
Escort 1,6 XR3 (ABS)	83-	ATE	TP.A-009	18,0			
Escort 1,6 XR3i (ABS)	83-	ATE	TP.A-009	18,0			
Escort 1,6 XR3i, RS	80-93	ATE	TP.A-009	18,0			
Escort 1,6; CL/CLX/Ghia /GT/S	5/91	BEN	TP.A-057	18,6			
Escort 1,6i L/LX	93-12/94	BEN	TP.A-057	18,6			
Escort 1,6 Mexiko	76-78	GIR	TP.A-070	15,1			
Escort 1,6; Nomade	93-	BEN	TP.A-057	18,6			
Escort 1,6i; S	91-12/91	BEN	TP.A-057	18,6			
Escort 1,8 RS	75-77	GIR	TP.A-070	15,1			
Escort 1,8i CL/CLD/CLX/CLXD	91-12/91	BEN	TP.A-057	18,6			
Escort 1,8i; Celebration/GLX	1/93	BEN	TP.A-057	18,6			
Escort 1,8i Ghia	4/91-	BEN	TP.A-057	18,6			
Escort 1,8i GT	93-94	BEN	TP.A-057	18,6			
Escort 1,8 L/Laser/LX	4/93-	BEN	TP.A-057	18,6			
Escort 1,8i Nomade	5/91-	BEN	TP.A-057	18,6			
Escort 1,8 TD/XLD Diesel	4/91-	BEN	TP.A-057	18,6			
Escort 1,8i XR3i	93-	BEN	TP.A-057	18,6			
Escort 2,0 RS 2000	73-80	GIR	TP.A-070	15,1			
Escort 1,6 D	80-90	ATE	TP.A-009	18,0			
Escort Cabrio 1,6 All Models	83-85	ATE	TP.A-009	18,0			
Escort Cabrio 1,6 All Models	85-	ATE	TP.A-009	18,0			
Escort Cabrio 1,6 Ghias	86-	ATE	TP.A-009	18,0			
Escort Cabrio 1,6i All Models	83-85	ATE	TP.A-009	18,0			

Марка автомобиля	Годы выпуска автомобиля	Передние колодки			Задние колодки		
		Тип тормозной системы	№ по каталогу	Толщина изделия, мм	Тип тормозной системы	№ по каталогу	Толщина изделия, мм
FORD							
Escort Cabrio 1,6 XR3i	86-	ATE	TP.A-009	18,0			
Escort Cosworth 2,0i Turbo 16V	92-				GIR	TP.A-016	13,5
Escort Express 1,6 35	80-86	ATE	TP.A-009	18,0			
Escort Express 1,6 55	80-86	ATE	TP.A-009	18,0			
Escort Express 1,6 D 35, 55	83-86	ATE	TP.A-009	18,0			
Escort Turnier 1,6 CL	86-90	ATE	TP.A-009	18,0			
Escort Turnier 1,6 D, C, CL	86-90	ATE	TP.A-009	18,0			
Escort Turnier 1,8 D C (ABS)	86-91	ATE	TP.A-009	18,0			
Escort Turnier 1,8 D, C, CL (ABS)	86-90	ATE	TP.A-009	18,0			
Escort 1,8 D C/CL/Bravo/Ghia	86-90	ATE	TP.A-009	18,0			
Escort 1,8 D Hardy Van/ D Koreier 55/ D Van/Wagan	9/90-	BEN	TP.A-057	18,6			
Escort 2,0i RS/RS Turbo	85-	ATE	TP.A-057	18,6			
Escort '91 Courier (AVL) 1,3	07/90 – 12/94	BEN	TP.A-057	18,6			
Escort '91 Courier (AVL) 1,4	07/90 – 12/94	BEN	TP.A-057	18,6			
Escort '91 Courier (AVL) 1,8 D	07/90 – 12/94	BEN	TP.A-057	18,6			
Escort '91 Express (AVL) 1,3	07/90 – 12/94	BEN	TP.A-057	18,6			
Escort '91 Express (AVL) 1,4	07/90 – 12/94	BEN	TP.A-057	18,6			
Escort '91 Express (AVL) 1,8 D	07/90 – 12/94	BEN	TP.A-057	18,6			
Escort IV Break (AWF, AVF) 1,1	10/85 – 09/90	ATE	TP.A-009	18,0			
Escort IV Break (AWF, AVF) 1,3	01/86 – 07/90	ATE	TP.A-009	18,0			
Escort IV Break (AWF, AVF) 1,4	01/86 – 07/90	ATE	TP.A-009	18,0			
Escort IV Break (AWF, AVF) 1,6 D	01/86 – 07/90	ATE	TP.A-009	18,0			
Escort IV Break (AWF, AVF) 1,8 D	01/89 – 07/90	ATE	TP.A-009	18,0			
Escort IV Estate (AWF, AVF) 1,1	10/85 – 09/90	ATE	TP.A-009	18,0			
Escort IV Estate (AWF, AVF) 1,3	01/86 – 07/90	ATE	TP.A-009	18,0			
Escort IV Estate (AWF, AVF) 1,4	01/86 – 07/90	ATE	TP.A-009	18,0			
Escort IV Estate (AWF, AVF) 1,6 D	01/86 – 07/90	ATE	TP.A-009	18,0			
Escort IV Estate (AWF, AVF) 1,8 D	01/89 – 07/90	ATE	TP.A-009	18,0			
Escort V (GAL) 1,3	07/90 – 09/92	BEN	TP.A-057	18,6			
Escort V (GAL) 1,4	07/90 – 09/92	BEN	TP.A-057	18,6			
Escort V (GAL) 1,6	07/90 – 12/92	BEN	TP.A-057	18,6			

Марка автомобиля	Годы выпуска автомобиля	Передние колодки			Задние колодки		
		Тип тормозной системы	№ по каталогу	Толщина изделия, мм	Тип тормозной системы	№ по каталогу	Толщина изделия, мм
FORD							
Escort V (GAL) 1,8 D (16V XR3i)	07/90 – 12/92	ATE BEN	TP.A-022 TP.A-057	17,5 18,6			
Escort V (GAL) RS 2000	05/91 – 12/92	ATE	TP.A-022	17,5			
Escort V Break (GAL, AVL) 1,3	09/91 – 09/92	BEN	TP.A-057	18,6			
Escort V Break (GAL, AVL) 1,4	07/90 – 09/92	BEN	TP.A-057	18,6			
Escort V Break (GAL, AVL) 1,6	07/90 – 09/92	BEN	TP.A-057	18,6			
Escort V Break (GAL, AVL) 1,8 D (16V)	07/90 – 12/92	ATE BEN	TP.A-022 TP.A-057	17,5 18,6			
Escort V Cabrio (ALL) 1,4	07/90 – 12/92	BEN	TP.A-057	18,6			
Escort V Cabrio (ALL) 1,6	07/90 – 12/92	BEN	TP.A-057	18,6			
Escort V Cabrio (ALL) 1,8 16V XR3i	02/92 – 12/92	ATE BEN	TP.A-022 TP.A-057	17,5 18,6			
Escort V Estate (GAL, AVL) 1,3	09/91 – 09/92	BEN	TP.A-057	18,6			
Escort V Estate (GAL, AVL) 1,4	07/90 – 09/92	BEN	TP.A-057	18,6			
Escort V Estate (GAL, AVL) 1,6	07/90 – 09/92	BEN	TP.A-057	18,6			
Escort V Estate (GAL, AVL) 1,8 D (16V)	07/90 – 12/92	ATE BEN	TP.A-022 TP.A-057	17,5 18,6			
Escort VI (GAL) 1,3	09/92 – 01/95	BEN	TP.A-057	18,6			
Escort VI (GAL) 1,4	09/92 – 01/95	BEN	TP.A-057	18,6			
Escort VI (GAL) 1,6i 16V	09/92 – 01/95	BEN	TP.A-057	18,6			
Escort VI (GAL) 1,8 D / TD	09/92 – 01/95	BEN	TP.A-057	18,6			
Escort VI (GAL) 1,8i 16V (XR3i 16V 4x4)	09/92 – 01/95	ATE BEN	TP.A-022 TP.A-057	17,5 18,6			
Escort VI (GAL) RS 2000	09/92 – 01/95	ATE	TP.A-022	17,5			
Escort VI (GAL) RS 2000 4x4	08/93 – 01/95	ATE	TP.A-022	17,5			
Escort VI (GAL) RS Cosworth 4x4	09/92 – 01/95						
Escort VI Break (GAL) 1,3	09/92 – 01/95	BEN	TP.A-057	18,6			
Escort VI Break (GAL) 1,4	09/92 – 01/95	BEN	TP.A-057	18,6			
Escort VI Break (GAL) 1,6i 16V	09/92 – 01/95	BEN	TP.A-057	18,6			
Escort VI Break (GAL) 1,8 D / TD	09/92 – 01/95	BEN	TP.A-057	18,6			
Escort VI Break (GAL) 1,8i 16V	01/93 – 01/95	ATE BEN	TP.A-022 TP.A-057	17,5 18,6			
Escort VI Cabrio (ALL) 1,4i	12/92 – 01/95	ATE BEN	TP.A-022 TP.A-057	17,5 18,6			
Escort VI Cabrio (ALL) 1,6i 16V (16V XR3i)	12/92 – 01/95	BEN	TP.A-057	18,6			

Марка автомобиля	Годы выпуска автомобиля	Передние колодки			Задние колодки		
		Тип тормозной системы	№ по каталогу	Толщина изделия, мм	Тип тормозной системы	№ по каталогу	Толщина изделия, мм
FORD							
Escort VI Cabrio (ALL) 1,8 16V XR3i	12/92 – 01/95	ATE BEN	TP.A-022 TP.A-057	17,5 18,6			
Escort VI Estate (GAL) 1,3	09/92 – 01/95	BEN	TP.A-057	18,6			
Escort VI Estate (GAL) 1,4	09/92 – 01/95	BEN	TP.A-057	18,6			
Escort VI Estate (GAL) 1,6i 16V	09/92 – 01/95	BEN	TP.A-057	18,6			
Escort VI Estate (GAL) 1,8 D / TD	09/92 – 01/95	BEN	TP.A-057	18,6			
Escort VI Estate (GAL) 1,8i 16V	01/93 – 01/95	BEN	TP.A-057	18,6			
Escort VI Sedan (GAL) 1,3	08/93 – 01/95	BEN	TP.A-057	18,6			
Escort VI Sedan (GAL) 1,4	08/93 – 01/95	ATE BEN	TP.A-022 TP.A-057	17,5 18,6			
Escort VI Sedan (GAL) 1,6i 16V	08/93 – 01/95	BEN	TP.A-057	18,6			
Escort VI Sedan (GAL) 1,8 D / TD	08/93 – 01/95	BEN	TP.A-057	18,6			
Escort VI Sedan (GAL) 1,8i 16V	08/93 – 01/95	ATE BEN	TP.A-022 TP.A-057	17,5 18,6			
Escort VII (GAL, AAL, ABL) 1,3	01/95 – 10/98	BEN	TP.A-057	18,6			
Escort VII (GAL, AAL, ABL) 1,4	01/95 – 10/98	ATE BEN	TP.A-022 TP.A-057	17,5 18,6			
Escort VII (GAL, AAL, ABL) 1,6 16V (4x4)	01/95 – 10/98	ATE BEN	TP.A-022 TP.A-057	17,5 18,6			
Escort VII (GAL, AAL, ABL) 1,8 D (16V)	01/95 – 10/98	ATE BEN	TP.A-022 TP.A-057	17,5 18,6			
Escort VII (GAL, AAL, ABL) 1,8 TD (Turbo D)	01/95 – 10/98	BEN	TP.A-057	18,6			
Escort VII (GAL, AAL, ABL) RS 2000	02/95 – 02/98	ATE	TP.A-022	17,5			
Escort VII (GAL, AAL, ABL) RS 2000 4x4	02/95 – 10/98	ATE	TP.A-022	17,5			
Escort VII (GAL, AAL, ABL) RS Cosworth 4x4	02/95 – 10/98						
Escort VII Cabrio (AAL) 1,4	02/95 – 08/98	BEN	TP.A-057	18,6			
Escort VII Cabrio (AAL) 1,8 16V XR3i	02/95 – 08/00	ATE BEN	TP.A-022 TP.A-057	17,5 18,6			
Escort VII Cabrio (AAL) 1,8 TD (Turbo D)	09/95 – 08/99	BEN	TP.A-057	18,6			
Escort VII Clipper (GAL, ANL) 1,3	01/95 – 01/99	BEN	TP.A-057	18,6			
Escort VII Clipper (GAL, ANL) 1,4	01/95 – 02/99	ATE BEN	TP.A-022 TP.A-057	17,5 18,6			
Escort VII Clipper (GAL, ANL) 1,6 i 16V	01/95 – 02/99	ATE BEN	TP.A-022 TP.A-057	17,5 18,6			
Escort VII Clipper (GAL, ANL) 1,8 D (16V)	01/95 – 02/99	ATE BEN	TP.A-022 TP.A-057	17,5 18,6			
Escort VII Clipper (GAL, ANL) 1,8 TD (Turbo D)	01/95 – 02/99	BEN	TP.A-057	18,6			
Escort VII Estate (GAL, ANL) 1,3	01/95 – 01/99	BEN	TP.A-057	18,6			

Марка автомобиля	Годы выпуска автомобиля	Передние колодки			Задние колодки		
		Тип тормозной системы	№ по каталогу	Толщина изделия, мм	Тип тормозной системы	№ по каталогу	Толщина изделия, мм
FORD							
Escort VII Estate (GAL, ANL) 1,4	01/95 – 02/99	ATE BEN	TP.A-022 TP.A-057	17,5 18,6			
Escort VII Estate (GAL, ANL) 1,6i 16V	01/95 – 02/99	ATE BEN	TP.A-022 TP.A-057	17,5 18,6			
Escort VII Estate (GAL, ANL) 1,8 D (16V)	01/95 – 02/99	ATE BEN	TP.A-022 TP.A-057	17,5 18,6			
Escort VII Estate (GAL, ANL) 1,8 TD (Turbo D)	01/95 – 02/99	BEN	TP.A-057	18,6			
Escort VII Sedan (GAL, AFL) 1,3	01/95 – 02/99	BEN	TP.A-057	18,6			
Escort VII Sedan (GAL, AFL) 1,4	01/95 – 02/99	ATE BEN	TP.A-022 TP.A-057	17,5 18,6			
Escort VII Sedan (GAL, AFL) 1,6i 16V	01/95 – 02/99	ATE BEN	TP.A-022 TP.A-057	17,5 18,6			
Escort VII Sedan (GAL, AFL) 1,8 D (TD, Turbo D)	01/95 – 02/99	ATE BEN	TP.A-022 TP.A-057	17,5 18,6			
Escort Classic (AAL, ABL) 1,6 16V	10/98 – 07/00	ATE BEN	TP.A-022 TP.A-057	17,5 18,6			
Escort Classic (Turnier) (AAL, ABL, ANL) 1,8 TD	10/98 – 07/00	BEN	TP.A-057	18,6			
Fiesta 1,0 C, L (ABS)	89-91	ATE	TP.A-009	18,0			
Fiesta 1,0 C, L	89-93	ATE	TP.A-009	18,0			
Fiesta 1,0 C, L (ABS)	91-93	ATE	TP.A-009	18,0			
Fiesta 1,1 CTX, CLX, Cheers, Ghia (ABS)	91-	ATE	TP.A-009	18,0			
Fiesta 1,1 CTX, CLX, Cheers, Ghia (ABS)	91-	ATE	TP.A-009	18,0			
Fiesta 1,1i CTX, CLX, Cheers, Ghia	89-91	ATE	TP.A-009	18,0			
Fiesta 1,3 CTX, CLX, Cheers, Ghia (ABS)	91-	ATE	TP.A-009	18,0			
Fiesta 1,3 Laurent (ABS)	93-	ATE	TP.A-009	18,0			
Fiesta 1,3i Newport, Bonus, Cheers, Ghia (ABS)	93-	ATE	TP.A-009	18,0			
Fiesta 1,3i Smokestohe CTX (ABS)	89	ATE	TP.A-009	18,0			
Fiesta 1,3 Laser, S, CTX (ABS)	89-91	ATE	TP.A-009	18,0			
Fiesta 1,3 Laser, S, CTX	89-91	ATE	TP.A-009	18,0			
Fiesta 1,4 CTX, CLX, Cheers, Ghia (ABS)	91-	ATE	TP.A-009	18,0			
Fiesta 1,4i CL, S (ABS)	89-91	ATE	TP.A-009	18,0			
Fiesta 1,4i Laurent (ABS)	93-	ATE	TP.A-009	18,0			
Fiesta 1,4i Smokestohe CTX (ABS)	89	ATE	TP.A-009	18,0			
Fiesta 1,6i 16V Ghia, RS, S (ABS)	93-	ATE	TP.A-009	18,0			
Fiesta 1,6i 16V Ghia, RS, S (ABS)	93-	ATE	TP.A-009	18,0			
Fiesta 1,6i 16V GT, RS, Si, XR2i, Magic (ABS)	93-	ATE	TP.A-009	18,0			
Fiesta 1,6i 16V S, XR2i (ABS)	89-	ATE	TP.A-009	18,0			
Fiesta 1,6 Supersport (ABS)	81-83	ATE	TP.A-009	18,0			
Fiesta 1,6 RX2	76-83	ATE	TP.A-009	18,0			
Fiesta 1,6 RX2 (ABS)	81-84	ATE	TP.A-009	18,0			
Fiesta 1,6 RX2	83-89	ATE	TP.A-009	18,0			
Fiesta 1,8i 16V RS, S, Si (ABS)	93-	ATE	TP.A-009	18,0			
Fiesta 1,8i 16V XR2, XR2i (ABS)	93-	ATE	TP.A-009	18,0			

Марка автомобиля	Годы выпуска автомобиля	Передние колодки			Задние колодки		
		Тип тормозной системы	№ по каталогу	Толщина изделия, мм	Тип тормозной системы	№ по каталогу	Толщина изделия, мм
FORD							
Fiesta 1,8 D All Models (ABS)	93-	ATE	TP.A-009	18,0			
Fiesta 1,8 D C, CL (ABS)	91-	ATE	TP.A-009	18,0			
Fiesta 1,8 D C, CL, Fineese, L, Laser	82-89	ATE	TP.A-009	18,0			
Fiesta 1,8 D Ghia (ABS)	93-	ATE	TP.A-009	18,0			
Fiesta 1,8 D Turbo DS (ABS)	91-	ATE	TP.A-009	18,0			
Fiesta Courier 1,3	96-	ATE	TP.A-009	18,0			
Fiesta Courier 1,4i	96-	ATE	TP.A-009	18,0			
Fiesta Courier 1,8 D	96-	ATE	TP.A-009	18,0			
Focus (DAW, DBW) 1,4 16V	10/98-11/04	ATE	TP.A-087	18,8			
Focus (DAW, DBW) 1,6 16V	10/98-11/04	ATE	TP.A-087	18,8			
Focus (DAW, DBW) 1,6 16V Flex fuel	01/02-11/04	ATE	TP.A-087	18,8			
Focus (DAW, DBW) 1,8 16V	10/98-11/04	ATE	TP.A-087	18,8			
Focus (DAW, DBW) 1,8 DI/TDDi 06/00-07/04	08/99-11/04	ATE	TP.A-087	18,8			
Focus (DAW, DBW) 1,8 TDCi	03/01-11/04	ATE	TP.A-087	18,8			
Focus (DAW, DBW) 1,8 Turbo DI/TDDi	10/98-11/04	ATE	TP.A-087	18,8			
Focus (DAW, DBW) 2,0 16V	10/98-11/04	ATE	TP.A-087	18,8			
Focus (DAW, DBW) 2,0 RS -07/04	10/02-11/04	ATE	TP.A-087	18,8			
Focus Clipper (DNW) 1,4 16V	02/99 – 11/04	ATE	TP.A-087	18,8			
Focus Clipper (DNW) 1,6 16V	02/99 – 11/04	ATE	TP.A-087	18,8			
Focus Clipper (DNW) 1,8 16V	02/99 – 11/04	ATE	TP.A-087	18,8			
Focus Clipper (DNW) 1,8 DI / TDDi	08/99 – 11/04	ATE	TP.A-087	18,8			
Focus Clipper (DNW) 1,8 TDCi	03/01 – 11/04	ATE	TP.A-087	18,8			
Focus Clipper (DNW) 1,8 Turbo DI / TDDi	02/99 – 11/04	ATE	TP.A-087	18,8			
Focus Clipper (DNW) 2,0 16V	02/99 – 11/04	ATE	TP.A-087	18,8			
Focus Estate (DNW) 1,4 16V	02/99-11/04	ATE	TP.A-087	18,8			
Focus Estate (DNW) 1,6 16V	02/99-11/04	ATE	TP.A-087	18,8			
Focus Estate (DNW) 1,6 16V Flex fuel	01/02-11/04	ATE	TP.A-087	18,8			
Focus Estate (DNW) 1,8 16V	02/99-11/04	ATE	TP.A-087	18,8			
Focus Estate (DNW) 1,8 Mi Fuel	02/03-01/05	ATE	TP.A-087	18,8			
Focus Estate (DNW) 1,8 DI/TDDi	08/99-11/04	ATE	TP.A-087	18,8			

Марка автомобиля	Годы выпуска автомобиля	Передние колодки			Задние колодки		
		Тип тормозной системы	№ по каталогу	Толщина изделия, мм	Тип тормозной системы	№ по каталогу	Толщина изделия, мм
FORD							
Focus Estate (DNW) 1,8 TDCi	03/01-11/04	ATE	TP.A-087	18,8			
Focus Estate (DNW) 1,8 Turbo DI/TDDi	02/99-11/04	ATE	TP.A-087	18,8			
Focus Estate (DNW) 2,0 16V	02/99-11/04	ATE	TP.A-087	18,8			
Focus Saloon (DFW) 1,4 16V	02/99-11/04	ATE	TP.A-087	18,8			
Focus Saloon (DFW) 1,6 16V	02/99-11/04	ATE	TP.A-087	18,8			
Focus Saloon (DFW) 1,8 16V -07/04	02/99-11/04	ATE	TP.A-087	18,8			
Focus Saloon (DFW) 1,8 TDCi	03/01-11/04	ATE	TP.A-087	18,8			
Focus Saloon (DFW) 1,8 TDdi	08/01-03/05	ATE	TP.A-087	18,8			
Focus Saloon (DFW) 1,8 Turbo DI/TDDi	02/99-11/04	ATE	TP.A-087	18,8			
Focus Saloon (DFW) 2,0 16V	02/99-11/04	ATE	TP.A-087	18,8			
Galaxy 1,9 TDi CLX	95-	ATE	TP.A-019	19,5	GIR	TP.A-014	17,4
Galaxy 2,0 CLX	95-	ATE	TP.A-019	19,5	GIR	TP.A-014	17,4
Galaxy 2,8i V6 GLX	95-	ATE	TP.A-019	19,5	GIR	TP.A-014	17,4
Galaxy 1,8 TDCi	05/06-	ATE	TP.A-079	19,0/20,0			
Galaxy 2,0	05/06-	ATE	TP.A-079	19,0/20,0			
Galaxy 2,0 TDCi	05/06	ATE	TP.A-079	19,0/20,0			
Galaxy 2,2 TDCi	03/08-	ATE	TP.A-079	19,0/20,0			
Galaxy 2,3	07/07-	ATE	TP.A-079	19,0/20,0			
Galaxy 1,6 TDCi	02/11 –	ATE ATE	TP.A-079 TP.A-091	19,0/20,0 18,2			
Galaxy 2,0 TDCi	03/10 –	ATE	TP.A-091	18,2			
Galaxy 2,2 TDCi	07/10 –	ATE	TP.A-091	18,2			
Galaxy 2,3 16V (WGR)	01/97 – 05/06	ATE	TP.A-019	19,5			
Granada I (GAE, GGE) 1,8	04/85 – 02/92	ATE	TP.A-022	17,5	GIR	TP.A-016	13,5
Granada I (GAE, GGE) 2,5 TD	08/93 – 09/94	ATE	TP.A-022	17,5	GIR	TP.A-016	13,5
Granada I Estate (GGE) 2,0i	09/91 – 09/94	ATE	TP.A-022	17,5	GIR	TP.A-016	13,5
Granada I Estate (GGE) 2,5 D	10/90 – 08/92	ATE	TP.A-022	17,5	GIR	TP.A-016	13,5
Granada I Estate (GGE) 2,5 TD	08/93 – 09/94	ATE	TP.A-022	17,5	GIR	TP.A-016	13,5
Granada I Estate (GGE) 2,9i	09/91 – 09/94				GIR	TP.A-016	13,5
Granada I Estate (GGE) 2,9i 4x4	05/88 – 02/93	ATE	TP.A-022	17,5	GIR	TP.A-016	13,5
Granada 1,7L	77-81	GIR	TP.A-070	15,1			
Granada 2,0 CL, GL, L (ABS)	84-92	ATE	TP.A-022	17,5	GIR	TP.A-016	13,5
Granada 2,1 Diesel L, GL	77-81	GIR	TP.A-070	15,1			
Granada 2,3 CL, GL, L (ABS)	84-92	ATE	TP.A-022	17,5	GIR	TP.A-016	13,5

Марка автомобиля	Годы выпуска автомобиля	Передние колодки			Задние колодки		
		Тип тормозной системы	№ по каталогу	Толщина изделия, мм	Тип тормозной системы	№ по каталогу	Толщина изделия, мм
FORD							
Granada 2,4i CL, GL, L (ABS)	84-92	ATE	TP.A-022	17,5	GIR	TP.A-016	13,5
Granada 2,9i 24V Scorpio (ABS)	92-	ATE	TP.A-022	17,5	GIR	TP.A-016	13,5
Granada 2,9i CL, GL, L (ABS)	84-92	ATE	TP.A-022	17,5	GIR	TP.A-016	13,5
Granada 2,9i Executive (ABS)	92-	ATE	TP.A-022	17,5	GIR	TP.A-016	13,5
Granada 2,5 D CL, GL, L (ABS)	84-92	ATE	TP.A-022	17,5	GIR	TP.A-016	13,5
Granada 2,5 D Turbo CLX (ABS)	89-92	ATE	TP.A-022	17,5	GIR	TP.A-016	13,5
Granada Turnier 2,0 L, GL	79-81	GIR	TP.A-070	15,1			
Granada Turnier 2,0 L, GL	80-85	GIR	TP.A-070	15,1			
Granada Turnier 2,3 L, LS, GL, GLS	79-81	GIR	TP.A-070	15,1			
Granada Turnier 2,5 Doesel L, GL	83-85	GIR	TP.A-070	15,1			
Mondeo 1,6i 16V CLX, Lxi	93-				GIR	TP.A-016	13,5
Mondeo 1,8i 16V CLX, Lxi	93-				GIR	TP.A-016	13,5
Mondeo 1,8i 16V CLX, Lxi (ABS)	93-				GIR	TP.A-016	13,5
Mondeo IV 1,6 TI	03/07-	ATE	TP.A-079	19,0/20,0			
Mondeo IV 1,8 TDCi	03/07-	ATE	TP.A-079	19,0/20,0			
Mondeo IV 2,0	03/07-	ATE	TP.A-079	19,0/20,0			
Mondeo IV 2,0 Flex fuel	03/07-	ATE	TP.A-079	19,0/20,0			
Mondeo IV 2,0 TDCi	03/07-	ATE	TP.A-079	19,0/20,0			
Mondeo IV 2,2 TDCi	03/08-	ATE	TP.A-079	19,0/20,0			
Mondeo IV 2,3	07/07	ATE	TP.A-079	19,0/20,0			
Mondeo IV 2,5	03/07	ATE	TP.A-079	19,0/20,0			
Mondeo IV Estate 1,6 TI	03/07	ATE	TP.A-079	19,0/20,0			
Mondeo IV Estate 1,8 TDCi	03/07	ATE	TP.A-079	19,0/20,0			
Mondeo IV Estate 2,0	03/07-	ATE	TP.A-079	19,0/20,0			
Mondeo IV Estate 2,0 Flex fuel	03/07-	ATE	TP.A-079	19,0/20,0			
Mondeo IV Estate 2,0 TDCi	03/07-	ATE	TP.A-079	19,0/20,0			
Mondeo IV Estate 2,2 TDCi	03/08-	ATE	TP.A-079	19,0/20,0			
Mondeo IV Estate 2,3	07/07-	ATE	TP.A-079	19,0/20,0			
Mondeo IV Estate 2,5	03/07-	ATE	TP.A-079	19,0/20,0			
Mondeo IV Saloon 2,0	03/07-	ATE	TP.A-079	19,0/20,0			
Mondeo IV Saloon 2,0 TDCi	03/07-	ATE	TP.A-079	19,0/20,0			
Mondeo IV Saloon 2,2 TDCi	03/08-	ATE	TP.A-079	19,0/20,0			
Mondeo IV Saloon 2,3	07/07-	ATE	TP.A-079	19,0/20,0			
Mondeo IV Saloon 2,5	03/07-	ATE	TP.A-079	19,0/20,0			
Mondeo IV 1,6 TDCi	02/11 –	ATE	TP.A-079 TP.A-091	19,0/20,0 18,2			
Mondeo IV 1,6 Ti	07/10 –	ATE	TP.A-091	18,2			
Mondeo IV 2,0 EcoBoost	07/10 –	ATE	TP.A-079 TP.A-091	19,0/20,0 18,2			
Mondeo IV 2,0 LPG	07/09 –	ATE	TP.A-079 TP.A-091	19,0/20,0 18,2			
Mondeo IV 2,0 SCTi	03/10 –	ATE	TP.A-079 TP.A-091	19,0/20,0 18,2			
Mondeo IV Saloon 1,6 Ti	03/07 –	ATE	TP.A-079 TP.A-091	19,0/20,0 18,2			
Mondeo IV Saloon 1,8 TDCi	03/07 –	ATE	TP.A-079 TP.A-091	19,0/20,0 18,2			
Mondeo IV Saloon 2,0 Flexi fuel	03/09 –	ATE	TP.A-091	18,2			
Mondeo IV Saloon 2,0 LPG	07/09 –	ATE	TP.A-091	18,2			
Mondeo IV Turnier 1,6 TDCi	02/11 –	ATE	TP.A-079 TP.A-091	19,0/20,0 18,2			

Марка автомобиля	Годы выпуска автомобиля	Передние колодки			Задние колодки		
		Тип тормозной системы	№ по каталогу	Толщина изделия, мм	Тип тормозной системы	№ по каталогу	Толщина изделия, мм
FORD							
Mondeo IV Turnier 1,6 Ti	03/07 –	ATE	TP.A-079 TP.A-091	19,0/20,0 18,2			
Mondeo IV Turnier 1,8 TDCi	03/07 –	ATE	TP.A-079 TP.A-091	19,0/20,0 18,2			
Mondeo IV Turnier 2,0	03/07 –	ATE	TP.A-079 TP.A-091	19,0/20,0 18,2			
Mondeo IV Turnier 2,0 EcoBoost	07/10 –	ATE	TP.A-079 TP.A-091	19,0/20,0 18,2			
Mondeo IV Turnier 2,0 Flexi fuel	03/09 –	ATE	TP.A-079 TP.A-091	19,0/20,0 18,2			
Mondeo IV Turnier 2,0 LPG	07/09 –	ATE	TP.A-079 TP.A-091	19,0/20,0 18,2			
Mondeo IV Turnier 2,0 SCTi	03/10 –	ATE	TP.A-079 TP.A-091	19,0/20,0 18,2			
Mondeo IV Turnier 2,0 TDCi	03/07 –	ATE	TP.A-079 TP.A-091	19,0/20,0 18,2			
Mondeo IV Turnier 2,2 TDCi	03/08 –	ATE	TP.A-079 TP.A-091	19,0/20,0 18,2			
Mondeo IV Turnier 2,3	07/07 –	ATE	TP.A-079 TP.A-091	19,0/20,0 18,2			
Mondeo IV Turnier 2,5	03/07 –	ATE	TP.A-079 TP.A-091	19,0/20,0 18,2			
Orion 1,3 CL, Bravo, Ghia	86-90	ATE	TP.A-009	18,0			
Orion 1,3 L, GL	83-85	BEN	TP.A-057	18,6			
Orion 1,3 L, GL (ABS)	85	ATE	TP.A-009	18,0			
Orion 1,4 Cli, Bravo, Ghia	86-90	ATE	TP.A-009	18,0			
Orion 1,4i All Models	9/90	BEN	TP.A-057	18,6			
Orion 1,6 CL, Bravo, Ghia, Gli, Laser	86-90	ATE	TP.A-009	18,0			
Orion 1,6 DL, GL (ABS)	85-	ATE	TP.A-009	18,0			
Orion 1,6 D, CL, Bravo, Ghia	86-90	ATE	TP.A-009	18,0			
Orion 1,6 DL, L, GL	83-85	ATE	TP.A-009	18,0			
Orion 1,6i Ghia Gli	86-90	ATE	TP.A-009	18,0			
Orion 1,6i Ghia Si	83-85	ATE	TP.A-009	18,0			
Orion 1,6i Ghia Si (ABS)	85-	ATE	TP.A-009	18,0			
Orion 1,6i L, GL	85-	ATE	TP.A-009	18,0			
Orion 1,6i L, GL	83-85	ATE	TP.A-009	18,0			
Orion 1,6i All Models	9/90-	BEN	TP.A-057	18,6			
Orion 1,8 D, CL, Bravo, Ghia (ABS)	86-90	ATE	TP.A-009	18,0			
Orion 1,8i 16V All Models	2/92-	BEN	TP.A-057	18,6			
Orion 1,8i Diesel XLD/Turbo Diesel	9/90-	BEN	TP.A-057	18,6			
Orion III (GAL) 1,3	07/90 – 12/93	BEN	TP.A-057	18,6			
Orion III (GAL) 1,4	07/90 – 12/93	BEN	TP.A-057	18,6			
Orion III (GAL) 1,6i (16V)	07/90 – 12/93	BEN	TP.A-057	18,6			
Orion III (GAL) 1,8 D (TD / i 16V)	11/90 – 12/93	BEN	TP.A-057	18,6			
P 100 1,8 All Models	3/87-93	BEN	TP.A-056	18,6			
P 100 2,0 All Models	3/87-93	BEN	TP.A-056	18,6			

Марка автомобиля	Годы выпуска автомобиля	Передние колодки			Задние колодки		
		Тип тормозной системы	№ по каталогу	Толщина изделия, мм	Тип тормозной системы	№ по каталогу	Толщина изделия, мм
FORD							
Probe 2,0i 16V	93-	SUM	TP.A-049	15,5 16,5	AKE	TP.A-064	14,0
Probe 2,5i 24V	93-	SUM	TP.A-049	15,5 16,5	AKE	TP.A-064	14,0
Scorpio 1,8 CL, GL (ABS)	85-	ATE	TP.A-022	17,5	GIR	TP.A-016	13,5
Scorpio 2,3 All Models (ABS)	96-				GIR	TP.A-016	13,5
Scorpio 2,9 All Models (ABS)	94-96				GIR	TP.A-016	13,5
Scorpio 2,0 CL, GL, CLX, GLX, Ghia (ABS)	85-92	ATE	TP.A-022	17,5	GIR	TP.A-016	13,5
Scorpio 2,0i CL, GL, Ghia (ABS)	94-				GIR	TP.A-016	13,5
Scorpio 2,0i CL, GL, Ghia (ABS)	85-94	ATE	TP.A-022	17,5	GIR	TP.A-016	13,5
Scorpio 2,4i GLX, Ghia, Excellence (ABS)	85-94	ATE	TP.A-022	17,5	GIR	TP.A-016	13,5
Scorpio 2,8i 4x4 GL, Ghia (ABS)	85-				GIR	TP.A-016	13,5
Scorpio 2,8i CL, Ghia (ABS)	85-92	ATE	TP.A-022	17,5	GIR	TP.A-016	13,5
Scorpio 2,9i 24V	96-				GIR	TP.A-016	13,5
Scorpio 2,9i 24V Cosworth, Executive (ABS)	92-				GIR	TP.A-016	13,5
Scorpio 2,9i 24V GL, GLX, Ghia (ABS)	85-	ATE	TP.A-022	17,5	GIR	TP.A-016	13,5
Scorpio 2,9i Ghia, 4x4, 24V, Excellence	92-				GIR	TP.A-016	13,5
Scorpio 2,9i GL, Ghia (ABS)	85-92	ATE	TP.A-022	17,5	GIR	TP.A-016	13,5
Scorpio 3,0 V6 4x4 GL, GLX, Ghia (ABS)	85-	ATE	TP.A-022	17,5	GIR	TP.A-016	13,5
Scorpio 3,0 V6 ind. Turnier (ABS)	85-92	ATE	TP.A-022	17,5	GIR	TP.A-016	13,5
Scorpio 2,5 D TD CLX, GLTD, TD GLX (ABS)	85-	ATE	TP.A-022	17,5	GIR	TP.A-016	13,5
Scorpio 2,5 D, CL, GL (ABS)	85-	ATE	TP.A-022	17,5	GIR	TP.A-016	13,5
Scorpio 2,5 D, CLX, GLX, TD (ABS)	92-				GIR	TP.A-016	13,5
Scorpio 2,5 D, CLX, GLX, TD (ABS)	94-				GIR	TP.A-016	13,5
Scorpio I Break (GGE) 2,0i	09/91 – 09/94	ATE	TP.A-022	17,5	GIR	TP.A-016	13,5
Scorpio I Break (GGE) 2,5 D	10/90 – 08/92	ATE	TP.A-022	17,5	GIR	TP.A-016	13,5
Scorpio I Break (GGE) 2,5 TD	08/93 – 09/94	ATE	TP.A-022	17,5	GIR	TP.A-016	13,5
Scorpio I Break (GGE) 2,9i	09/91 – 09/94				GIR	TP.A-016	13,5
Scorpio I Break (GGE) 2,9i 4x4	05/88 – 02/93	ATE	TP.A-022	17,5	GIR	TP.A-016	13,5
Scorpio I Estate (GGE) 2,0i	09/91 – 09/94	ATE	TP.A-022	17,5	GIR	TP.A-016	13,5
Scorpio I Estate (GGE) 2,5 D	10/90 – 08/92	ATE	TP.A-022	17,5	GIR	TP.A-016	13,5
Scorpio I Estate (GGE) 2,5 TD	08/93 – 09/94	ATE	TP.A-022	17,5	GIR	TP.A-016	13,5
Scorpio I Estate (GGE) 2,9i	09/91 – 09/94				GIR	TP.A-016	13,5
Scorpio I Estate (GGE) 2,9i 4x4	05/88 – 02/93	ATE	TP.A-022	17,5	GIR	TP.A-016	13,5
Scorpio I Sedan (GGE) 2,0i	05/89 – 09/94	ATE	TP.A-022	17,5	GIR	TP.A-016	13,5
Scorpio I Sedan (GGE) 2,4i	10/88 – 10/94	ATE	TP.A-022	17,5	GIR	TP.A-016	13,5

Марка автомобиля	Годы выпуска автомобиля	Передние колодки			Задние колодки		
		Тип тормозной системы	№ по каталогу	Толщина изделия, мм	Тип тормозной системы	№ по каталогу	Толщина изделия, мм
FORD							
Scorpio I Sedan (GGE) 2,5 D	12/89 – 12/94	ATE	TP.A-022	17,5	GIR	TP.A-016	13,5
Scorpio I Sedan (GGE) 2,5 TD	06/88 – 09/94	ATE	TP.A-022	17,5	GIR	TP.A-016	13,5
Scorpio I Sedan (GGE) 2,9i	09/86 – 12/94	ATE	TP.A-022	17,5			
Scorpio I Sedan (GGE) 2,9i 24V	04/91 – 09/94				GIR	TP.A-016	13,5
Scorpio II Break (GNR, GGR) 2,0i	10/94 – 08/98				GIR	TP.A-016	13,5
Scorpio II Break (GNR, GGR) 2,0i 16V	10/94 – 08/98				GIR	TP.A-016	13,5
Scorpio II Break (GNR, GGR) 2,3i 16V	06/96 – 08/98				GIR	TP.A-016	13,5
Scorpio II Break (GNR, GGR) 2,5 TD	10/94 – 08/98				GIR	TP.A-016	13,5
Scorpio II Break (GNR, GGR) 2,9i	02/95 – 08/98				GIR	TP.A-016	13,5
Scorpio II Break (GNR, GGR) 2,9i 24V	10/94 – 08/98				GIR	TP.A-016	13,5
Scorpio II Estate (GNR, GGR) 2,0i	10/94 – 08/98				GIR	TP.A-016	13,5
Scorpio II Estate (GNR, GGR) 2,0i 16V	10/94 – 08/98				GIR	TP.A-016	13,5
Scorpio II Estate (GNR, GGR) 2,3i 16V	06/96 – 08/98				GIR	TP.A-016	13,5
Scorpio II Estate (GNR, GGR) 2,5 TD	10/94 – 08/98				GIR	TP.A-016	13,5
Scorpio II Estate (GNR, GGR) 2,9i	02/95 – 08/98				GIR	TP.A-016	13,5
Scorpio II Estate (GNR, GGR) 2,9i 24V	10/94 – 08/98				GIR	TP.A-016	13,5
S-Max 1,6 TDCi	02/11 –	ATE	TP.A-079 TP.A-091	19,0 20,0 18,2			
Sierra 1,2 L, Coustom	82-87	GIR	TP.A-013	17,5			
Sierra 1,2 L, LG, Ghia	82-87	GIR	TP.A-013	17,5			
Sierra 1,6 Azur, L, CL, E, GLLX, Ghia	87-	ATE	TP.A-009	18,0			
Sierra 1,6 Azur, L,CL, E, GLLX, Ghia (ABS)	87-	ATE	TP.A-009	18,0			
Sierra 1,6i CL, CLX	89-91	ATE	TP.A-009	18,0			
Sierra 1,6i CL, CLX (ABS)	89-93	ATE	TP.A-022	17,5	GIR	TP.A-016	13,5
Sierra 1,6i CL, CLX	91-93	ATE	TP.A-009	18,0			
Sierra 1,6 L, CL, Lasser E, Ghia	82-87	GIR	TP.A-013	17,5			
Sierra 1,6 Van	5/91	BEN	TP.A-056	18,6			
Sierra 1,8 L, CL, Coupe, LX, L, Lasser Ghia	87-	ATE	TP.A-009	18,0			
Sierra 1,8 L, CL, Coupe, LX, L, Lasser Ghia (ABS)	87-	ATE	TP.A-009	18,0	GIR	TP.A-016	13,5
Sierra 1,8 L, CL, Lasser, Ghia	82-87	ATE	TP.A-009	18,0			
Sierra 1,8 LT, Lasser, TT, CL, Ghia LX (ABS)	87-89	ATE	TP.A-022	17,5	GIR	TP.A-016	13,5
Sierra 1,8 L, CL, Lasser, Ghia	82-87	ATE	TP.A-013	17,5			
Sierra 1,8 Van Diesel	4/90-	ATE	TP.A-056	18,6			
Sierra 2,0 CL, CLX, GL, GLS, GLX, Ghia (ABS)	82-87				GIR	TP.A-016	13,5
Sierra 2,0i All Models (ABS)	82-87				GIR	TP.A-016	13,5

Марка автомобиля	Годы выпуска автомобиля	Передние колодки			Задние колодки		
		Тип тормозной системы	№ по каталогу	Толщина изделия, мм	Тип тормозной системы	№ по каталогу	Толщина изделия, мм
FORD							
Sierra 2,0i CLX, XR (ABS)	89-93	ATE	TP.A-022	17,5	GIR	TP.A-016	13,5
Sierra 2,0i GL, Ghia, S, CL	87-	ATE	TP.A-009	18,0			
Sierra 2,0i GL, Ghia, S, CL (ABS)	87-	ATE	TP.A-009	18,0	GIR	TP.A-016	13,5
Sierra 2,0i S, GL, Ghia	82-87	ATE	TP.A-009	18,0			
Sierra 2,0i S, GL, Ghia (ABS)	82-87	ATE	TP.A-009	18,0	GIR	TP.A-016	13,5
Sierra 2,0 L, CL, GL, Ghia	87-	ATE	TP.A-009	18,0			
Sierra 2,0 L, CL, GL, Ghia (ABS)	87-	ATE	TP.A-009	18,0	GIR	TP.A-016	13,5
Sierra 2,0 L, GL, Ghia	82-87	ATE	TP.A-009	18,0			
Sierra 2,0 L, GL, Ghia (ABS)	82-87	ATE	TP.A-009	18,0	GIR	TP.A-016	13,5
Sierra 2,0i S, GL, Ghia	82-87	ATE	TP.A-013	17,5			
Sierra 2,0 L, GL, Ghia	82-87	ATE	TP.A-013	17,5			
Sierra 2,3 GL, GLS, L, Ghia	82-87	ATE	TP.A-009	18,0			
Sierra 2,3 Laser, inc. Turnier	82-87	ATE	TP.A-009	18,0			
Sierra 2,8i ES, Ghia, XR (ABS)	85-				GIR	TP.A-016	13,5
Sierra 2,8i XR 4x4 (ABS)	82-	ATE	TP.A-022	17,5	GIR	TP.A-016	13,5
Sierra 2,8i XR 4x4	85-	GIR	TP.A-013	17,5	GIR	TP.A-016	13,5
Sierra 2,8i XR4i (ABS)	82-				GIR	TP.A-016	13,5
Sierra 2,9i 4x4, XR 4x4 (ABS)	88-	ATE	TP.A-022	17,5	GIR	TP.A-016	13,5
Sierra 1,8 D Turbo (ABS)	88-90	ATE	TP.A-022	17,5	GIR	TP.A-016	13,5
Sierra 1,8 D Turbo Azu (ABS)	88-90				GIR	TP.A-016	13,5
Sierra 2,3 DL, GL	82-87	ATE	TP.A-009	18,0			
Sierra 2,3 DL, GL Laser inc. Turnier	82-87	ATE	TP.A-009	18,0			
Sierra 2,3 DL, GL Laser inc. Turnier	88-90				GIR	TP.A-016	13,5
Sierra 2,3 D Laser L, GL, CL	87	ATE	TP.A-009	18,0			
Sierra Combi 1,6 EM, Laser	81-87	GIR	TP.A-013	17,5			
Sierra Combi 1,8 CL, GL, GLX, LT, Laser (ABS)	88-89				GIR	TP.A-016	13,5
Sierra Combi 1,8 D Turbo, CL, CLX	90-91	ATE	TP.A-009	18,0			
Sierra Combi 1,8 D Turbo, CL, CLX (ABS)	92-93				GIR	TP.A-016	13,5
Sierra Combi 2,0 CL, GL, Ghia	84-87	ATE	TP.A-009	18,0			
Sierra Combi 2,3 D Turbo, CL, CLX	90-91	ATE	TP.A-009	18,0			
Sierra Combi 1,8 D Turbo, CL, CLX (ABS)	92-93				GIR	TP.A-016	13,5
Sierra 2,0i 16V RS Cosworth 4x4 (ABS)	90-93	GIR	TP.A-013	17,5	GIR	TP.A-016	13,5
Sierra 2,0i 16V Turbo Cosworth 4x4 (ABS)	85-93				GIR	TP.A-016	13,5
Sierra 2,0i Cosworth RS	82-	GIR	TP.A-013	17,5	GIR	TP.A-016	13,5
Sierra 2,0i RS Cosworth	81-86	ATE	TP.A-009	18,0			
Sierra 2,0i RS Cosworth 4x4 (ABS)	88-90				GIR	TP.A-016	13,5
Sierra 2,0i RS Cosworth 4x4 (ABS)	92-93				GIR	TP.A-016	13,5
Sierra Turnier 1,8	82-87	GIR	TP.A-013	17,5			
Sierra Turnier 1,8	82-87	ATE	TP.A-009	18,0			
Sierra Turnier 2,0	82-87	ATE	TP.A-009	18,0			
Sierra Turnier 2,0	82-87	GIR	TP.A-013	17,5			
Sierra Turnier 2,3	82-87	ATE	TP.A-009	18,0			
Sierra Turnier 2,8i Ghia 4x4 (ABS)	82-				GIR	TP.A-016	13,5
Sierra Turnier 2,9i V6Ghia 4x4 (ABS)	82-				GIR	TP.A-016	13,5
Sierra Turnier 3,0i 4x4 (ABS)	82-				GIR	TP.A-016	13,5
S-Max 1,8 TDCi	05/06-	ATE	TP.A-079	19,0/20,0			

Марка автомобиля	Годы выпуска автомобиля	Передние колодки			Задние колодки		
		Тип тормозной системы	№ по каталогу	Толщина изделия, мм	Тип тормозной системы	№ по каталогу	Толщина изделия, мм
FORD							
S-Max 2,0	05/06-	ATE	TP.A-079	19,0/20,0			
S-Max 2,0 Flex fuel	05/06-	ATE	TP.A-079	19,0/20,0			
S-Max 2,0 TDCi	05/06-	ATE	TP.A-079	19,0/20,0			
S-Max 2,2 TDCi	03/08-	ATE	TP.A-079	19,0/20,0			
S-Max 2,3	07/07-	ATE	TP.A-079	19,0/20,0			
S-Max 2,5 ST	05/06-	ATE	TP.A-079	19,0/20,0			
Taurus All Models	-73	ATE	TP.A-001	15,0			
Taurus 1,3 L	76-82	GIR	TP.A-070	15,1			
Taurus 1,6 L, GL, Ghia	76-82	GIR	TP.A-070	15,1			
Taurus 2,0 L, LS, GL, GLS, Ghia	76-82	GIR	TP.A-070	15,1			
Taurus 2,3 LS, GLS, Ghia	76-82	GIR	TP.A-070	15,1			
Transit 80 2,0 Bus (ABS)	91-	BDX	TP.A-036	18,7			
Transit 80 2,5 All Models (ABS)	91-	BDX	TP.A-036	18,7			
Transit 80 Combi 2,0 (ABS)	91-	BDX	TP.A-036	18,7			
Transit 80 2,5 Diesel	85-3/91	BDX	TP.A-056	18,6			
Transit 100 1,6	85-88	BDX	TP.A-056	18,6			
Transit 100 2,0 All Models	9/85-91	BDX	TP.A-056	18,6			
Transit 100 2,0 L, S, Topline Euroline (ABS)	91-	BDX	TP.A-036	18,7			
Transit 100 2,5 Diesel	9/85-91	BDX	TP.A-056	18,6			
Transit 100 2,5 DL,S,Topline Euroline (ABS)	91-	BDX	TP.A-036	18,7			
Transit 120 2,5 Diesel	85-6/91	BDX	TP.A-056	18,6			
Transit FT 100 (MKII) (72E2A) 1,5;1,6;2,0	70-78	AP	TP.A-043	18,0			
Transit FT 100 (MKII) (VLS/VVS) 1,6;2,0\$2,3	78-86	AP	TP.A-043	18,0			
Transit FT 100L (MKII) (VUL) 2,0;2,4 Diesel; 2,5 Diesel	76-86	AP	TP.A-043	18,0			
Transit FT 120 (MKII) (VLS/VDS/VVS) 2,0;4,4 Diesel	78-85	AP	TP.A-043	18,0			
Transit FT 130 (MKII) 2,0;2,5 Diesel (2835 кр)	70-86	AP	TP.A-043	18,0			
Transit FT 130 (MKII) (TEL) 2,0;2,0 Cfi; 2,5 Diesel; 2,5 Turbodiesel	86-91	AP	TP.A-043	18,0			
Transit FT 150 (MKII) 2,0	72-78	AP	TP.A-043	18,0			
Transit FT 160 (MKII) 2,0/2,4 Diesel/ 2,5 Diesel	78-91	AP	TP.A-043	18,0			
Transit FT 175 (MKII) 2,0/2,4 Diesel	70-78	AP	TP.A-043	18,0			
Transit FT 190 (MKII) 2,0/2,4 Diesel/2,5 Diesel	76-86	AP	TP.A-043	18,0			
Transit FT 190 (MKII) 2,0/2,0 Cfi/2,5 Di/2,5 Di Turbo	86-	AP	TP.A-043	18,0			
Transit 150 (MKIII) 2,5 DL/S	91-	BDX	TP.A-044	18,7			
Transit 150 (MKIII) 2,9i	91-	BDX	TP.A-044	18,7			
Transit 190 (MKIII)	91-	BDX	TP.A-044	18,7			
Transit 190 (MKIII) 2,5 D Turbo	91-	BDX	TP.A-044	18,7			
Transit Box 2,2 TDCi 330, 350, Ø280,0 mm	07/06-	BO	TP.A-089	18,8			
Transit Box 2,2 TDCi 330, 350, Ø300,0 mm	07/06-	BO	TP.A-089	18,8			
Transit Box 2,2 TDCi Ø280,0 mm	07/06-	BO	TP.A-089	18,8			
Transit Box 2,2 TDCi Ø300,0 mm	07/06-	BO	TP.A-089	18,8			
Transit Box 2,3 16V Ø280,0 mm	07/06-	BO	TP.A-089	18,8			
Transit Box 2,3 16V Ø300,0 mm	07/06-	BO	TP.A-089	18,8			
Transit Box 2,4 TDCi	07/06-	BO	TP.A-089	18,8			

Марка автомобиля	Годы выпуска автомобиля	Передние колодки			Задние колодки		
		Тип тормозной системы	№ по каталогу	Толщина изделия, мм	Тип тормозной системы	№ по каталогу	Толщина изделия, мм
FORD							
Transit Box 3,2 TDCi 350	09/07-	BO	TP.A-089	18,8			
Transit Box (FA_) 2,0 DI	08/00-05/06	BO	TP.A-085	18,4			
Transit Box (FA_) 2,3	03/01-03/06	BO	TP.A-085	18,4			
Transit Box (FA_) 2,3 300	03/01-03/06	BO	TP.A-085	18,4			
Transit Box (FA_) 2,3 350	03/01-03/06	BO	TP.A-085	18,4			
Transit Box (FA_) 2,3 16V	03/01-03/06	BO	TP.A-085	18,4			
Transit Box (FA_) 2,4 DI	04/01-05/06	BO	TP.A-085	18,4			
Transit Box (FA_) 2,4 DI (RWD)	01/00-05/06	BO	TP.A-085	18,4			
Transit Box (FA_) 2,4 TD	01/00-05/06	BO	TP.A-085	18,4			
Transit Box (FA_) 2,4 TD, 330	08/00-08/03	BO	TP.A-085	18,4			
Transit Box (FA_) 2,4 TDCi	08/00-08/03	BO	TP.A-085	18,4			
Transit Box (FA_) 2,4 TDDi	03/04-05/06	BO	TP.A-085	18,4			
Transit Box (FA_) 2,4 TDE	08/00-08/03	BO	TP.A-085	18,4			
Transit Box (FA_) 2,4 TDE, -08/03, 330	07/01-05/06	BO	TP.A-085	18,4			
Transit Box (FA_) 2,4 TDE, 08/03, 350	07/01-05/06	BO	TP.A-085	18,4			
Transit Box (FA_) 2,4 TDE, 300	07/01-05/06	BO	TP.A-085	18,4			
Transit Box 2,2 TDCi [RWD]	10/11 –	BO	TP.A-089	19,0			
Transit Box (E_) 2,0 (EAL, EAS)	09/91 – 03/00	BDX	TP.A-036 TP.A-044	18,7			
Transit Box (E_) 2,0i (EAL, EAS)	09/91 – 06/94	BDX	TP.A-036 TP.A-044	18,7			
Transit Box (E_) 2,5 DI (TD / TDI) (EAL, EAS)	05/91 – 03/00	BDX	TP.A-036 TP.A-044	18,7			
Transit Box (T_) 1,6 (TAS)	09/85 – 09/92	BDX	TP.A-056	18,6			
Transit Box (T_) 2,0 (TAL, TAS, TGL, TWS)	09/85 – 09/92	AP BDX	TP.A-043 TP.A-056	18,0 18,6			
Transit Box (T_) 2,5 D (TAL, TAS, TGL, TWS)	01/86 – 09/91	AP BDX	TP.A-044 TP.A-056	18,7 18,6			
Transit Bus 2,2 TDCi [RWD]	10/11 –	BO	TP.A-089	19,0			
Transit Bus (E_) 2,0 (EBL, EBS, ECL, EDS, EDL, EGL, ESS, ESL, EUS)	09/91 – 03/00	BDX	TP.A-036 TP.A-044	18,7			
Transit Bus (E_) 2,0i (EBL, EDL, EGL, ESS, EUS)	09/91 – 07/94	BDX	TP.A-036 TP.A-044	18,7			
Transit Bus (E_) 2,0 CNG	06/94 – 03/00	BDX	TP.A-036 TP.A-044	18,7			
Transit Bus (E_) 2,5 DI / TD (EBS, EDS, EDL, ESS, EUS)	08/91 – 06/00	BDX	TP.A-036 TP.A-044	18,7			
Transit Bus (E_) 2,9i	01/91 – 09/94	BDX	TP.A-036	18,7			
Transit Bus (T_) 2,0 (KAT) (TBS, TCL, TCS, TEL, TES)	11/85 – 09/92	AP BDX	TP.A-043 TP.A-056	18,0 18,6			
Transit Bus (T_) 2,5 D (TBS, TCL, TCS, TEL, TES)	12/85 – 01/89	AP BDX	TP.A-043 TP.A-056	18,0 18,6			
Transit Bus 2,2 TDCi 300, 350, Ø280,0 mm	07/06-	BO	TP.A-089	18,8			
Transit Bus 2,2 TDCi 300, 350, Ø300,0 mm	07/06-	BO	TP.A-089	18,8			
Transit Bus 2,2 TDCi Ø280,0 mm	07/06-	BO	TP.A-089	18,8			
Transit Bus 2,2 TDCi Ø300,0 mm	07/06-	BO	TP.A-089	18,8			
Transit Bus 2,4 TDCi	07/06-	BO	TP.A-089	18,8			
Transit Bus 3,2 TDCi	02/08-	BO	TP.A-089	18,8			

Марка автомобиля	Годы выпуска автомобиля	Передние колодки			Задние колодки		
		Тип тормозной системы	№ по каталогу	Толщина изделия, мм	Тип тормозной системы	№ по каталогу	Толщина изделия, мм
FORD							
Transit Bus (FD_, FB_, FS_, FZ_, FC_) (2,0 DI) 2,3 16V [RWD], 330	0800-0506	ВО	TP.A-085	18,4			
Transit Bus (FD_, FB_, FS_, FZ_, FC_) 2,3 16V [RWD], 350	0800-0506	ВО	TP.A-085	18,4			
Transit Bus (FD_, FB_, FS_, FZ_, FC_) 2,4 DI, -09/01, 330	0100-0506	ВО	TP.A-085	18,4			
Transit Bus (FD_, FB_, FS_, FZ_, FC_) 2,4 DI, -10/01, 300	0100-0506	ВО	TP.A-085	18,4			
Transit Bus (FD_, FB_, FS_, FZ_, FC_) 2,4 DI, 350	0100-0506	ВО	TP.A-085	18,4			
Transit Bus (FD_, FB_, FS_, FZ_, FC_) 2,4 DL [RWD], -08/03, 330	0100-0506	ВО	TP.A-085	18,4			
Transit Bus (FD_, FB_, FS_, FZ_, FC_) 2,4 DL [RWD], 330, 350	0100-0506	ВО	TP.A-085	18,4			
Transit Bus (FD_, FB_, FS_, FZ_, FC_) 2,4 DL [RWD], 350	0100-0506	ВО	TP.A-085	18,4			
Transit Bus (FD_, FB_, FS_, FZ_, FC_) 2,4 TD	0800-0803	ВО	TP.A-085	18,4			
Transit Bus (FD_, FB_, FS_, FZ_, FC_) 2,4 TDCi	0304-0506	ВО	TP.A-085	18,4			
Transit Bus (FD_, FB_, FS_, FZ_, FC_) 2,4 TDDi	0800-0306	ВО	TP.A-085	18,4			
Transit Bus (FD_, FB_, FS_, FZ_, FC_) 2,4 TDE	0701-0506	ВО	TP.A-085	18,4			
Transit Bus (FD_, FB_, FS_, FZ_, FC_) 2,4 TDE, -08/03, 330	0701-0506	ВО	TP.A-085	18,4			
Transit Bus (FD_, FB_, FS_, FZ_, FC_) 2,4 TDE, -08/03, 350	0701-0506	ВО	TP.A-085	18,4			
Transit Bus (FD_, FB_, FS_, FZ_, FC_) 2,4 TDE, 300	0701-0506	ВО	TP.A-085	18,4			
Transit Flatbed/ Shassis (FM_, FN_) 2,3, 350	0301-0306	ВО	TP.A-085	18,4			
Transit Flatbed/ Shassis (FM_, FN_) 2,3 16V, 330	0401-0506	ВО	TP.A-085	18,4			
Transit Flatbed/ Shassis (FM_, FN_) 2,3 16V, 350	0401-0506	ВО	TP.A-085	18,4			
Transit Flatbed/ Shassis (FM_, FN_) 2,4 DI, -08/03, 425	0100-0506	ВО	TP.A-085	18,4			
Transit Flatbed/ Shassis (FM_, FN_) 2,4 DI, 330	0100-0506	ВО	TP.A-085	18,4			
Transit Flatbed/ Shassis (FM_, FN_) 2,4 DI, 350	0100-0506	ВО	TP.A-085	18,4			
Transit Flatbed/ Shassis (FM_, FN_) 2,4 TDCi	0304-0506	ВО	TP.A-085	18,4			
Transit Flatbed/ Shassis (FM_, FN_) 2,4 TDDi	0800-0506	ВО	TP.A-085	18,4			
Transit Flatbed/ Shassis (FM_, FN_) 2,4 TDE	0701-0506	ВО	TP.A-085	18,4			
Transit Flatbed/ Shassis (FM_, FN_) 2,4 TDE, -08/03, 330	0701-0506	ВО	TP.A-085	18,4			
Transit Flatbed/ Shassis (FM_, FN_) 2,4 TDE, -08/03, 350	0701-0506	ВО	TP.A-085	18,4			
Transit Flatbed/ Shassis (FM_, FN_) 2,4 TDE, -08/03, 410	0701-0506	ВО	TP.A-085	18,4			
Transit Flatbed/ Shassis (FM_, FN_) 2,4 TDE, -08/03, 425	0701-0506	ВО	TP.A-085	18,4			

Марка автомобиля	Годы выпуска автомобиля	Передние колодки			Задние колодки		
		Тип тормозной системы	№ по каталогу	Толщина изделия, мм	Тип тормозной системы	№ по каталогу	Толщина изделия, мм
HONDA							
Civic V Hatchback (MB) 1,4 16V, -10/98, ABS(+), Ø240,0 mm	01/97-02/01	TRW	TP.A-074	18,0			
Civic V Hatchback (MB) 1,4 16V, -10/98, ABS(+), Ø259,6 mm	01/97-02/01	TRW	TP.A-074	18,0			
Civic V Hatchback (MB) 1,4 16V, -10/98, ABS(+), Ø262,0 mm	01/97-02/01	TRW	TP.A-074	18,0			
Civic V Hatchback (MB) 1,4 16V, ABS(+), Ø259,6 mm	01/97-02/01	TRW	TP.A-074	18,0			
Civic V Hatchback (MB) 1,4 16V, ABS(+), Ø262,0 mm	01/97-02/01	TRW	TP.A-074	18,0			
Civic V Hatchback (MB) 1,5	01/97-02/01	TRW	TP.A-074	18,0			
Civic V Hatchback (MB) 1,6	11/98-10/00	TRW	TP.A-074	18,0			
Civic V Hatchback (MB) 1,6 16V, -10/00, ABS(+)	01/97-02/01	TRW	TP.A-074	18,0			
Civic V Hatchback (MB) 2,0 iTD, -10/00	01/97-02/01	TRW	TP.A-074	18,0			
Civic V Hatchback (MB) 2,0 TDiC	11/98-10/00	TRW	TP.A-074	18,0			
Concerto (HW) 1,4	08/89-10/92	TRW	TP.A-074	18,0			
Concerto (HW) 1,5i 16V ABS(+)	08/89-10/92	TRW	TP.A-074	18,0			
Concerto (HW) 1,6	10/89-10/92	TRW	TP.A-074	18,0			
Concerto (HW) 1,6 16V	08/89-03/95	TRW	TP.A-074	18,0			
Concerto (HW) 1,6 16V i	08/89-03/95	TRW	TP.A-074	18,0			
Concerto (HW) 1,8 TD, ABS(+)	08/94-10/96	TRW	TP.A-074	18,0			
Concerto Saloon (HWW) 1,4	08/89-10/92	TRW	TP.A-074	18,0			
Concerto Saloon (HWW) 1,5 i16V, ABS(+)	08/89-05/95	TRW	TP.A-074	18,0			
Concerto Saloon (HWW) 1,6	10/89-10/92	TRW	TP.A-074	18,0			
Concerto Saloon (HWW) 1,6 16V	08/89-03/95	TRW	TP.A-074	18,0			
Concerto Saloon (HWW) 1,6 I 16V	08/89-03/95	TRW	TP.A-074	18,0			
Ledend (HS/KA) 2,5i V6 Cat	87-89	GIR	TP.A-026	17,5			
Ledend (HS/KA) 2,7i V6 (Sedan)	90-	GIR	TP.A-026	17,5			
HYUNDAI							
Accent 1,3i GLS/L/LS (ABS)	9/94-	AKE	TP.A-059	14,8			
Accent 1,5i GLS/L/LS (ABS)	9/94-	AKE	TP.A-059	14,8			
Accent II (LC) 1,5	09/00 – 11/05	AKE	TP.A-059	14,8			
Accent II (LC) 1,6	12/02 – 11/05	AKE	TP.A-059	14,8			
Accent Sedan (LC) 1,6	12/02 – 11/05	AKE	TP.A-059	14,8			
Accent Sedan (X-3) 1,3 i 12V	10/94 – 01/00	AKE	TP.A-059	14,8			
Accent Sedan (X-3) 1,5 i 12V (16V)	10/94 – 01/00	AKE	TP.A-059	14,8			
Alantra 1,5i all models	90-	AKE	TP.A-059	14,8			
Alantra 1,6i all models	90-	SUM	TP.A-060	17,0			
Alantra 1,8i all models	95-	SUM	TP.A-060	17,0			

Марка автомобиля	Годы выпуска автомобиля	Передние колодки			Задние колодки		
		Тип тормозной системы	№ по каталогу	Толщина изделия, мм	Тип тормозной системы	№ по каталогу	Толщина изделия, мм
HYUNDAI							
Avante II (J-2) 1,5 12V	12/96 – 09/00	SUM	TP.A-060	17,0			
Avante II (J-2) 1,6 16V	11/95 – 09/00	SUM	TP.A-060	17,0			
Avante II (J-2) 1,8 16V	11/95 – 09/00	SUM	TP.A-060	17,0			
Avante II (J-2) 2,0 16V	08/96 – 09/00	SUM	TP.A-060	17,0			
Coupe (RD) 2,0 16V (FX)	08/96 – 04/02	SUM	TP.A-060	17,0			
Elantra I (J-1) 1,5 i.e.	10/90 – 11/95	AKE	TP.A-059	14,8			
Elantra I (J-1) 1,6 i.e. 16V	10/90 – 11/95	SUM	TP.A-060	17,0			
Elantra I (J-1) 1,8 i.e. 16V	10/90 – 11/95	SUM	TP.A-060	17,0			
Elantra II (J-2) 1,5 12V	12/96 – 09/00	SUM	TP.A-060	17,0			
Elantra II (J-2) 1,6 16V	11/95 – 09/00	SUM	TP.A-060	17,0			
Elantra II (J-2) 1,8 16V	11/95 – 09/00	SUM	TP.A-060	17,0			
Elantra II (J-2) 2,0 16V	08/96 – 09/00	SUM	TP.A-060	17,0			
Elantra II Estate (J-2) 1,5 12V	04/97 – 10/00	SUM	TP.A-060	17,0			
Elantra II Estate (J-2) 1,6i (16V)	02/96 – 10/00	SUM	TP.A-060	17,0			
Elantra II Estate (J-2) 1,8 16V	02/96 – 10/00	SUM	TP.A-060	17,0			
Elantra II Estate (J-2) 1,9 D	03/98 – 10/00	SUM	TP.A-060	17,0			
Elantra II Estate (J-2) 2,0 16V	12/96 – 10/00	SUM	TP.A-060	17,0			
Excel 1,3i all models	89-	AKE	TP.A-059	14,8			
Excel 1,5 all models	89-	AKE	TP.A-059	14,8			
Excel 1,5i all models	89-6/90	AKE	TP.A-059	14,8			
Excel I (X-3) 1,3i 12V	10/94 – 01/00	AKE	TP.A-059	14,8			
Excel I (X-3) 1,5i 12V (16V)	10/94 – 01/00	AKE	TP.A-059	14,8			
Excel II (LC) 1,5	09/00 – 11/05	AKE	TP.A-059	14,8			
Excel II (LC) 1,6	12/02 – 11/05	AKE	TP.A-059	14,8			
Excel Sedan (X-2) 1,5i	01/90 – 01/95	AKE	TP.A-059	14,8			
Excel Sedan (X-3) 1,3i 12V	10/94 – 01/00	AKE	TP.A-059	14,8			
Excel Sedan (X-3) 1,5i 12V (16V)	10/94 – 01/00	AKE	TP.A-059	14,8			

Марка автомобиля	Годы выпуска автомобиля	Передние колодки			Задние колодки		
		Тип тормозной системы	№ по каталогу	Толщина изделия, мм	Тип тормозной системы	№ по каталогу	Толщина изделия, мм
HYUNDAI							
Grace Box 2,5 D	07/93 – 03/00	TRW	TP.A-096	18,0			
Grace Bus (P) 2,4	07/93 – 03/00	TRW	TP.A-096	18,0			
Grace Bus 2,5 D	07/93-06/94	TRW	TP.A-096	18,0			
Grace Bus 2,5 TD	06/98-10/01	TRW	TP.A-096	18,0			
Grace Bus 2,6 D	10/99-10/04	TRW	TP.A-096	18,0			
H-1 Bus (KMF) 2,5 D -05/98, Ø253,0 mm	10/97-	TRW	TP.A-096	18,0			
H-1 Bus (KMF) 2,5 D -05/98, Ø254,0 mm	10/97-	TRW	TP.A-096	18,0			
H 100 Box 2,4	10/97-	TRW	TP.A-096	18,0			
H 100 Box 2,5 D	07/93-03/00	TRW	TP.A-096	18,0			
H 100 Box 2,6 D	10/99-	TRW	TP.A-096	18,0			
H 100 Bus (P) 2,4	07/93-03/00	TRW	TP.A-096	18,0			
H 100 Bus (P) 2,5 D	07/93-03/00	TRW	TP.A-096	18,0			
H 100 Bus (P) 2,5 TD 07/94-	07/93-03/00	TRW	TP.A-096	18,0			
H 100 Bus (P) 2,6 D	10/99-	TRW	TP.A-096	18,0			
H 100 Flatbed/Chassis 2,4	05/96-12/97	TRW	TP.A-096	18,0			
H 100 Flatbed/Chassis 2,5 D	07/93-12/97	TRW	TP.A-096	18,0			
H 100 Pickup 2,5 D	05/96-10/01	TRW	TP.A-096	18,0			
H 100 / Grace Box 2,5 D	07/93 – 03/00	TRW	TP.A-096	18,0			
H 100 / Grace Bus (P) 2,4	07/93 – 03/00	TRW	TP.A-096	18,0			
H 100 / Grace Bus (P) 2,5 D / TD	07/93 – 03/00	TRW	TP.A-096	18,0			
H 150 Box 2,5 D	07/93 – 03/00	TRW	TP.A-096	18,0			
H 150 Bus (P) 2,4	07/93 – 03/00	TRW	TP.A-096	18,0			
H 150 Bus (P) 2,5 D / TD	07/93 – 03/00	TRW	TP.A-096	18,0			
H 200 2,5 D	10/97 – 04/04	TRW	TP.A-096	18,0			
Lantra 1,5i all models	1/91-	AKE	TP.A-059	14,8			
Lantra 1,6i all models	1/91-	SUM	TP.A-060	17,0			
Lantra 1,8i all models	9/92-	SUM	TP.A-060	17,0			
Lantra II (J-2) 1,5 12V	12/96 – 09/00	SUM	TP.A-060	17,0			
Lantra II (J-2) 1,6 16V	11/95 – 09/00	SUM	TP.A-060	17,0			
Lantra II (J-2) 1,8 16V	11/95 – 09/00	SUM	TP.A-060	17,0			

Марка автомобиля	Годы выпуска автомобиля	Передние колодки			Задние колодки		
		Тип тормозной системы	№ по каталогу	Толщина изделия, мм	Тип тормозной системы	№ по каталогу	Толщина изделия, мм
HYUNDAI							
Lantra II (J-2) 2,0 16V	08/96 – 09/00	SUM	TP.A-060	17,0			
Lantra II Break (J-2) 1,5 12V	04/97 – 10/00	SUM	TP.A-060	17,0			
Lantra II Break (J-2) 1,6i (16V)	02/96 – 10/00	SUM	TP.A-060	17,0			
Lantra II Break (J-2) 1,8 16V	02/96 – 10/00	SUM	TP.A-060	17,0			
Lantra II Break (J-2) 1,9 D	03/98 – 10/00	SUM	TP.A-060	17,0			
Lantra II Break (J-2) 2,0 16V	12/96 – 10/00	SUM	TP.A-060	17,0			
Lantra II Sedan (J-2) 1,5 12V	12/96 – 09/00	SUM	TP.A-060	17,0			
Lantra II Sedan (J-2) 1,6 16V	11/95 – 09/00	SUM	TP.A-060	17,0			
Lantra II Sedan (J-2) 1,8 16V	11/95 – 09/00	SUM	TP.A-060	17,0			
Lantra II Sedan (J-2) 2,0 16V	08/96 – 09/00	SUM	TP.A-060	17,0			
Lantra II Wagon (J-2) 1,5 12V	04/97 – 10/00	SUM	TP.A-060	17,0			
Lantra II Wagon (J-2) 1,6i (16V)	02/96 – 10/00	SUM	TP.A-060	17,0			
Lantra II Wagon (J-2) 1,8 16V	02/96 – 10/00	SUM	TP.A-060	17,0			
Lantra II Wagon (J-2) 1,9 D	03/98 – 10/00	SUM	TP.A-060	17,0			
Lantra II Wagon (J-2) 2,0 16V	12/96 – 10/00	SUM	TP.A-060	17,0			
Pony 1,3 all models	89-6/90	AKE	TP.A-059	14,8			
Pony 1,3i all models	7/90-	AKE	TP.A-059	14,8			
Pony 1,3 XP all models	89-6/90	AKE	TP.A-059	14,8			
Pony 1,3i XP all models	7/90-92	AKE	TP.A-059	14,8			
Pony 1,5 all models	89-6/90	AKE	TP.A-059	14,8			
Pony 1,5i all models	7/90-	AKE	TP.A-059	14,8			
Pony 1,5 XP all models	89-6/90	AKE	TP.A-059	14,8			
Pony 1,5i XP all models	7/90-	AKE	TP.A-059	14,8			
Pony / Excel Sedan (X-2) 1,5i	01/90 – 01/95	AKE	TP.A-059	14,8			
Pony Sedan (X-3) 1,3i 12V	10/94 – 01/00	AKE	TP.A-059	14,8			
Pony Sedan (X-3) 1,5i 12V (16V)	10/94 – 01/00	AKE	TP.A-059	14,8			
Porter Box 2,5 CRDi Ø253,0 mm	02/03-	TRW	TP.A-096	18,0			
Porter Box 2,5 CRDi Ø254,0 mm	02/03-	TRW	TP.A-096	18,0			
Porter Box 2,5 TD	07/94-04/04	TRW	TP.A-096	18,0			
Porter Box 2,6 TD	07/94-04/04	TRW	TP.A-096	18,0			
Porter Bus 2,5 CRDi	02/03-04/04	TRW	TP.A-096	18,0			

Марка автомобиля	Годы выпуска автомобиля	Передние колодки			Задние колодки		
		Тип тормозной системы	№ по каталогу	Толщина изделия, мм	Тип тормозной системы	№ по каталогу	Толщина изделия, мм
HYUNDAI							
Porter Bus 2,5 TD	07/94-04/04	TRW	TP.A-096	18,0			
Porter Pickup 2,5 CRDi	02/03-04/04	TRW	TP.A-096	18,0			
Porter Pickup 2,5 TD	07/94-04/04	TRW	TP.A-096	18,0			
Porter Pickup 2,6 TD	07/94-04/04	TRW	TP.A-096	18,0			
Satallite 2,5 D	10/97 – 04/04	TRW	TP.A-096	18,0			
S-Coupe 1,5i all models	90-9/96	AKE	TP.A-059	14,8			
Sonata 1,8i GL/GLS/GLX	90-95	SUM	TP.A-060	17,0			
Sonata 2,0i CD/CD (ABS)	92-8/95	SUM	TP.A-060	17,0			
Sonata 2,0i GLS CDS/GLS CDS (ABS)	92-6/96	SUM	TP.A-060	17,0			
Sonata 2,0i Speciale 16S	92-8/95	SUM	TP.A-060	17,0			
Sonata 2,4i GLS/ 16V	88-96	SUM	TP.A-060	17,0			
Sonata 3,0i DLX/GLX/SDXL Automatic/ V6 CD/LD (ABS)/GLS/Top (ABS)	9/89-95	SUM	TP.A-060	17,0			
Sonata III (Y-3) 1,8i	05/93 – 06/98	SUM	TP.A-060	17,0			
Sonata III (Y-3) 2,0i (16V)	06/94 – 06/98	SUM	TP.A-060	17,0			
Sonata III (Y-3) 3,0i V6	05/93 – 06/98	SUM	TP.A-060	17,0			
Sonata III Sedan (Y-3) 1,8i	05/93 – 06/98	SUM	TP.A-060	17,0			
Sonata III Sedan (Y-3) 2,0i (16V)	06/94 – 06/98	SUM	TP.A-060	17,0			
Sonata III Sedan (Y-3) 3,0i V6	05/93 – 06/98	SUM	TP.A-060	17,0			
Sonata IV (EF) 2,0 16V	06/98 – 10/01	SUM	TP.A-060	17,0			
Sonata IV (EF) 2,4 16V	03/98 – 10/01	SUM	TP.A-060	17,0			
Sonata IV Sedan (EF) 2,0 16V	06/98 – 10/01	SUM	TP.A-060	17,0			
Sonata IV Sedan (EF) 2,4 16V	03/98 – 10/01	SUM	TP.A-060	17,0			
Somca 2,0i GLS	93-95	SUM	TP.A-060	17,0			
Stellar 1,4 L, LX	84-86	LUC	TP.A-070	15,1			
Stellar 1,6 GLS/GL (Mc Pherson)	86-2/90	AKE	TP.A-059	14,8			
Stellar 1,6 SL, SV	84-89	LUC	TP.A-070	15,1			
Stellar 1,6 LX, SL	84-86	LUC	TP.A-070	15,1			
Stellar 2,0 GLS (Mc Pherson)	86-2/90	AKE	TP.A-059	14,8			
Tiburon (RD) 2,0 16V (FX)	08/96 – 04/02	SUM	TP.A-060	17,0			
Verna Sedan (LC) 1,6	12/02 – 11/05	AKE	TP.A-059	14,8			

Марка автомобиля	Годы выпуска автомобиля	Передние колодки			Задние колодки		
		Тип тормозной системы	№ по каталогу	Толщина изделия, мм	Тип тормозной системы	№ по каталогу	Толщина изделия, мм
INFINITI							
G20 2,0	01/90 – 12/97	SUM	TP.A-060	17,0			
M30 Convertible 3,0	01/90 – 12/93	AKE	TP.A-030	16,8			
M30 Coupe 3,0	01/89 – 12/93	AKE	TP.A-030	16,8			
IVECO							
Ekus 75.28.32.35.40.46.50.56	87-	ATE	TP.A-006	18,5			
Ekus 100.28.32.35.40.46.50.56	87-	ATE	TP.A-006	18,5			
EuroCargo (209, 240, 275 л.с.)	2000 –	KNORR SB 7000	TP.A-115	30,0	KNORR SB 7000	TP.A-115	30,0
EuroCargo (218, 252 л.с.)	2006 –	KNORR SB 7000	TP.A-115	30,0	KNORR SB 7000	TP.A-115	30,0
EuroCargo (251 л.с.)	2009 –	KNORR SB 7000	TP.A-115	30,0	KNORR SB 7000	TP.A-115	30,0
EuroStar (375, 420, 430 л.с.)	1993 – 2002	KNORR SB 7000	TP.A-115	30,0	KNORR SB 7000	TP.A-115	30,0
EuroStar (390 л.с.)	1999 – 2002	KNORR SB 7000	TP.A-115	30,0	KNORR SB 7000	TP.A-115	30,0
EuroStar (400 л.с.)	2000 – 2002	KNORR SB 7000	TP.A-115	30,0	KNORR SB 7000	TP.A-115	30,0
EuroTech MH (245, 272, 310, 352 л.с.)	1998 –	KNORR SB 7000	TP.A-115	30,0	KNORR SB 7000	TP.A-115	30,0
EuroTech MH (296 л.с.)	2000 –	KNORR SB 7000	TP.A-115	30,0	KNORR SB 7000	TP.A-115	30,0
EuroTech MP (420 л.с.)	1992 – 1993	KNORR SB 7000	TP.A-115	30,0	KNORR SB 7000	TP.A-115	30,0
EuroTech MP (345, 375 л.с.)	1992 – 1996	KNORR SB 7000	TP.A-115	30,0	KNORR SB 7000	TP.A-115	30,0
EuroTech MP (301 л.с.)	1997 –	KNORR SB 7000	TP.A-115	30,0	KNORR SB 7000	TP.A-115	30,0
EuroTech MP (390, 430 л.с.)	1999 –	KNORR SB 7000	TP.A-115	30,0	KNORR SB 7000	TP.A-115	30,0
EuroTech MP (400 л.с.)	2000 –	KNORR SB 7000	TP.A-115	30,0	KNORR SB 7000	TP.A-115	30,0
EuroTech MP (437, 456, 477, 481, 507, 509, 526, 558, 589 л.с.)	2002 –	KNORR SB 7000	TP.A-115	30,0	KNORR SB 7000	TP.A-115	30,0
EuroTech MT (239, 267, 301, 345 л.с.)	1992 – 1998	KNORR SB 7000	TP.A-115	30,0	KNORR SB 7000	TP.A-115	30,0
Cacciamali Thesi 59F12 chassis Iveco 15-04		ATE	TP.A-028	20,0			
Grinta OM 59.12	89-	ATE	TP.A-028	20,0			
Daily, Turbo Daily 40.10	96-		TP.A-027	20,0			
Daily 49.12 Turbo	97-		TP.A-027	20,0			
Stralis (400, 430, 480, 540 л.с.)	2002 –	KNORR SB 7000	TP.A-115	30,0	KNORR SB 7000	TP.A-115	30,0
Stralis (272, 296, 310, 352 л.с.)	2003 –	KNORR SB 7000	TP.A-115	30,0	KNORR SB 7000	TP.A-115	30,0
Stralis (330, 420, 422, 450, 500, 560 л.с.)	2006 –	KNORR SB 7000	TP.A-115	30,0	KNORR SB 7000	TP.A-115	30,0
Stralis (360 л.с.)	2007 –	KNORR SB 7000	TP.A-115	30,0	KNORR SB 7000	TP.A-115	30,0

Марка автомобиля	Годы выпуска автомобиля	Передние колодки			Задние колодки		
		Тип тормозной системы	№ по каталогу	Толщина изделия, мм	Тип тормозной системы	№ по каталогу	Толщина изделия, мм
IVECO							
Stralis (272 л.с.)	2008 –	KNORR SB 7000	TP.A-115	30,0	KNORR SB 7000	TP.A-115	30,0
Trakker (310, 352, 360, 380, 440 л.с.)	2004 –	KNORR SB 7000	TP.A-115	30,0	KNORR SB 7000	TP.A-115	30,0
Trakker (272, 420 л.с.)	2005 –	KNORR SB 7000	TP.A-115	30,0	KNORR SB 7000	TP.A-115	30,0
Trakker (330, 410, 450 л.с.)	2006 –	KNORR SB 7000	TP.A-115	30,0	KNORR SB 7000	TP.A-115	30,0
IVECO-FIAT							
40, 10W, WV, WS, Turbo	89-	PER	TP.A-034	18,0			
45, 10 V Turbo	86-	PER	TP.A-034	18,0			
45, 10 Turbo	86-	PER	TP.A-034	18,0			
49, 10 V Turbo	86-	PER	TP.A-034	18,0			
49, 10 Turbo	86-	PER	TP.A-034	18,0			
Daily 40 2,0 40.8	86-	PER	TP.A-034	18,0			
Daily 40 2,4 D 40.12	84-86	PER	TP.A-034	18,0			
Daily 40 2,5 D 40.12	86-	PER	TP.A-034	18,0			
Daily 40 2,5 D 40.8	78-83	PER	TP.A-034	18,0			
Daily 45 2,4 All Models	87-89	PER	TP.A-034	18,0			
Daily 45 2,5 All Models	90-	PER	TP.A-034	18,0			
Grinta OM 45.10\$ 49.10	89-	PER	TP.A-034	18,0			
JAGUAR							
Sovereign 2,9	1/90-93	ATE	TP.A-061	17,5			
Sovereign 3,2	1/90-	ATE	TP.A-061	17,5			
Sovereign 3,6	1/90-93	ATE	TP.A-061	17,5			
Sovereign 4,0	1/90-94	ATE	TP.A-061	17,5			
Vanden Plas (NAW, NBW) 8 3,2	07/97 – 05/03	ATE	TP.A-061	17,5			
Vanden Plas (NAW, NBW) 8 (R) 4,0	07/97 – 05/03	ATE	TP.A-061	17,5			
Vanden Plas (X300) 12 (6,0)	11/94 – 07/97	ATE	TP.A-061	17,5			
Vanden Plas (X300) 6 3,2	11/94 – 07/97	ATE	TP.A-061	17,5			
Vanden Plas (X300) 6 Sovereign 4,0	11/94 – 07/97	ATE	TP.A-061	17,5			
Vanden Plas (X300) R Super Charged 4,0	11/94 – 07/97	ATE	TP.A-061	17,5			
Xj 6 2,9	90-93	ATE	TP.A-061	17,5			
Xj 6 3,2	90-	ATE	TP.A-061	17,5			
Xj 6 3,6	90-93	ATE	TP.A-061	17,5			
Xj 6 4,0	91-94	ATE	TP.A-061	17,5			

Марка автомобиля	Годы выпуска автомобиля	Передние колодки			Задние колодки		
		Тип тормозной системы	№ по каталогу	Толщина изделия, мм	Тип тормозной системы	№ по каталогу	Толщина изделия, мм
JAGUAR							
Xj 6 4,0 S Berlin 24V	94-	ATE	TP.A-061	17,5			
Xj 12 6,0 12V	90-94	ATE	TP.A-061	17,5			
Xj 220 3,5 C-Type V6 24V	6/90-	ATE	TP.A-061	17,5			
Xj R-S 6,0 V12	8/90-	ATE	TP.A-061	17,5			
Xj R-S 6,0 V12 Sedan	91-	ATE	TP.A-061	17,5			
XjS 4,0 Cuope	91-94	ATE	TP.A-061	17,5			
XjS 6,0 V12	93-94	ATE	TP.A-061	17,5			
Xj – SC 4,0	92-95	ATE	TP.A-061	17,5			
Xj – SC 5,3 V12	91-93	ATE	TP.A-061	17,5			
Xj – SC 6,0 V12	93-95	ATE	TP.A-061	17,5			
Xj (NAW, NBW) 8 3,2	07/97 – 05/03	ATE	TP.A-061	17,5			
Xj (NAW, NBW) 8 (R) 4,0	07/97 – 05/03	ATE	TP.A-061	17,5			
Xj (X300) 12 (6,0)	11/94 – 07/97	ATE	TP.A-061	17,5			
Xj (X300) 6 3,2	11/94 – 07/97	ATE	TP.A-061	17,5			
Xj (X300) 6 Sovereign 4,0	11/94 – 07/97	ATE	TP.A-061	17,5			
Xj (X300) R Super Charged 4,0	11/94 – 07/97	ATE	TP.A-061	17,5			
Xj Sedan (NAW, NBW) 8 3,2	07/97 – 05/03	ATE	TP.A-061	17,5			
Xj Sedan (NAW, NBW) 8 (R) 4,0	07/97 – 05/03	ATE	TP.A-061	17,5			
Xj Sedan (X300) 12 (6,0)	11/94 – 07/97	ATE	TP.A-061	17,5			
Xj Sedan (X300) 6 3,2	11/94 – 07/97	ATE	TP.A-061	17,5			
Xj Sedan (X300) 6 Sovereign 4,0	11/94 – 07/97	ATE	TP.A-061	17,5			
Xj Sedan (X300) R Super Charged 4,0	11/94 – 07/97	ATE	TP.A-061	17,5			
XK8 4,0 V8	96-	ATE	TP.A-061	17,5			
XK8 Convertible (QDV) 4,2 R4,2, 03/06-, Ch.→B00378	08/02-	ATE	TP.A-079	19,0/20,0			
XK Convertible 3,6 -12/08-, Ch.→B00378	10/07-	ATE	TP.A-079	19,0/20,0			
XK Convertible 4,2 XK8	03/06-	ATE	TP.A-079	19,0/20,0			
XK Convertible 4,2 XKR Ch.→B00378	03/06-	ATE	TP.A-079	19,0/20,0			
XK Coupe 3,5XK	07/07-	ATE	TP.A-079	19,0/20,0			
XK Coupe 4,2 XK8	03/06-	ATE	TP.A-079	19,0/20,0			
XK Coupe 4,2 XKR	03/06-	ATE	TP.A-079	19,0/20,0			
XK Coupe 4,2 XKR Ch.→B00378	03/06-	ATE	TP.A-079	19,0/20,0			

Марка автомобиля	Годы выпуска автомобиля	Передние колодки			Задние колодки		
		Тип тормозной системы	№ по каталогу	Толщина изделия, мм	Тип тормозной системы	№ по каталогу	Толщина изделия, мм
JAGUAR							
XK 8 Coupe (QEV) 4,0	03/96 – 07/05	ATE	TP.A-061	17,5			
XK 8 Coupe (QEV) (R) 4,2	08/02 – 07/05	ATE	TP.A-061	17,5			
KIA							
Magentis (GD) 2,0	05/01 –	SUM	TP.A-060	17,0			
Optima (GD) 2,0	05/01 –	SUM	TP.A-060	17,0			
Optima Sedan (GD) 2,0	05/01 –	SUM	TP.A-060	17,0			
Sephia 1,6i	95-	AKE	TP.A-009	18,0			
LAMBORGHINI							
Countach LP400	01/74 – 12/82	ATE	TP.A-021	15,0			
Countach LP500	01/74 – 12/74	ATE	TP.A-021	15,0			
Countach LP500 S	01/82 – 12/85	ATE	TP.A-021	15,0			
Diablo GT 5,9	10/99 –	ATE	TP.A-021	15,0			
Diablo SE	01/94 – 12/96	ATE	TP.A-021	15,0			
Diablo VT	01/90 – 08/98	ATE	TP.A-021	15,0			
LANCIA							
Dedra 1,6i E (ABS)	89-	GIR	TP.A-012	17,0			
Dedra 1,8i E (ABS)	89-	GIR	TP.A-012	17,0			
Dedra 2,0i E (ABS)	89-	GIR	TP.A-012	17,0			
Dedra 2,0i Turbo Integrale	89-	GIR	TP.A-012	17,0			
Dedra (835EB) 1,6 LE KAT	07/94 – 07/99	GIR	TP.A-012	17,0			
Thema 1,6	84-88				GIR	TP.A-007	16,4
Thema 1,6	88-				GIR	TP.A-007	16,4
Thema 2,0i iE 16 V (ABS)	90-				GIR	TP.A-007	16,4
Thema 2,0i iE 16 V Turbo (ABS)	90-				GIR	TP.A-007	16,4
Thema 2,0i Turbo iE (ABS)	87-				GIR	TP.A-007	16,4
Thema 2,0i Turbo iE (ABS)	89-				GIR	TP.A-007	16,4
Thema 2,0i E (ABS)	84-88				GIR	TP.A-007	16,4
Thema 2,0i E (ABS)	88-				GIR	TP.A-007	16,4
Thema 2,0i E 16V, Turbo (ABS)	84-88						
Thema 2,0i E 16V, Turbo (ABS)	88-				GIR	TP.A-007	16,4
Thema 2,0i E Turbo (ABS)	84-						
Thema 2,0 Turbo 16V (ABS)	84-88				GIR	TP.A-007	16,4
Thema 2,0 Turbo 16V (ABS)	88-				GIR	TP.A-007	16,4
Thema 2,8i VG (ABS)	84-				GIR	TP.A-007	16,4

Марка автомобиля	Годы выпуска автомобиля	Передние колодки			Задние колодки		
		Тип тормозной системы	№ по каталогу	Толщина изделия, мм	Тип тормозной системы	№ по каталогу	Толщина изделия, мм
LANCIA							
Thema 3,0i E V8 32V (ABS)	87-				GIR	TP.A-007	16,4
Thema 3,0 V8 32V (ABS)	90-				GIR	TP.A-007	16,4
Thema 2,4 D Turbo DS (ABS)	84-90				GIR	TP.A-007	16,4
Thema 2,5 D Turbo DS (ABS)	84-						
Thema 2,5 D Turbo DS (ABS)	90-				GIR	TP.A-007	16,4
Thema 2,8i Turbo DS (ABS)	84-88				GIR	TP.A-007	16,4
Thema 2,8i Turbo DS (ABS)	88-				GIR	TP.A-007	16,4
Thema 3,0 Restyling TD 16 V (ABS)	90-				GIR	TP.A-007	16,4
Thema SW (834) 2000 i.e. 16V (834AA)	05/89 – 08/92				GIR	TP.A-007	16,4
Thema SW (834) 2000 i.e. 16V Turbo (834AC)	12/88 – 06/90				GIR	TP.A-007	16,4
Thema SW (834) 2000 i.e. 16V Turbo (834AL)	04/89 – 03/93				GIR	TP.A-007	16,4
Thema SW (834) 2000 Turbo	01/89 – 03/92				GIR	TP.A-007	16,4
Thema SW (834) 2000 Turbo 16V (834GC, 834FC)	11/92 – 07/94				GIR	TP.A-007	16,4
Thema SW (834) 2500 Turbo DS (834D)	03/87 – 09/90				GIR	TP.A-007	16,4
Thema SW (834) 3000 V6 (834GD, 834FD)	09/92 – 07/94				GIR	TP.A-007	16,4
Y10 1,0 Fire (156AA)	03/85 – 06/89	BDX	TP.A-033	18,0			
Y10 1,0 Fire (156AE) KAT	10/87 – 02/92	BDX	TP.A-033	18,0			
Y10 1,0 Fire (156B, 156C, 156AD)	03/85 – 06/91	GIR BDX	TP.A-012 TP.A-033	17,0 18,0			
Y10 1,0 Turbo (156D)	03/85 – 02/89	BDX	TP.A-033	18,0			
Y10 1,1 i.e. (156AC)	08/89 – 06/92	BDX	TP.A-033	18,0			
Y10 1,1 i.e. Fire (156AG)	07/89 – 09/95	BDX	TP.A-033	18,0			
LAND ROVER							
90/110 (DHMC) 2,5 4x4	09/85 – 07/90	AP	TP.A-043	18,0			
90/110 (DHMC) 3,5 V8 4x4	09/83 – 07/90	AP	TP.A-043	18,0			
Defender Cabrio (LD) 2,5 D 4x4	09/90 – 09/01	AP	TP.A-043	18,0			
Defender Cabrio (LD) 2,5 90 TDI 4x4	09/90 –	AP	TP.A-043	18,0			
Defender Cabrio (LD) 2,5 Td5 4x4	06/98 –	AP	TP.A-043	18,0			
Defender Station Wagon (LD) 2,5 90,110 TDI 4x4	09/90 – 12/98	AP	TP.A-043	18,0			
Defender Station Wagon (LD) 2,5 D 4x4	09/90 – 09/01	AP	TP.A-043	18,0			

Марка автомобиля	Годы выпуска автомобиля	Передние колодки			Задние колодки		
		Тип тормозной системы	№ по каталогу	Толщина изделия, мм	Тип тормозной системы	№ по каталогу	Толщина изделия, мм
LAND ROVER							
Defender Station Wagon (LD) 2,5 Td5 4x4	06/98 –	AP	TP.A-043	18,0			
Defender Station Wagon (LD) 3,9 V8 4x4	11/98 –	AP	TP.A-043	18,0			
Defender Pick-Up (LD) 2,5 Td5 4x4	06/98 –	AP	TP.A-043	18,0			
Freelander (LN) 1,8 16V	11/00-	ATE	TP.A-091	18,2			
Freelander (LN) 2,0 Td4	11/00-	ATE	TP.A-091	18,2			
Freelander 2 (FA_) 2,0 Si4 4x4	10/11 –	ATE	TP.A-079 TP.A-091	19,0/20,0 18,2			
Freelander 2 (FA_) 2,2 SD4 4x4 (eD4)	08/10 –	ATE	TP.A-079 TP.A-091	19,0/20,0 18,2			
Freelander (LN) 2,5 V6 4x4	11/00 – 10/06	ATE	TP.A-091	18,2			
Freelander Soft Top 1,8i 16V 4x4	02/98 – 10/06	ATE	TP.A-091	18,2			
LR2 (FA_) 2,0 Si4 4x4	10/11 –	ATE	TP.A-079 TP.A-091	19,0/20,0 18,2			
LR2 (FA_) 2,2 SD4 4x4 (eD4)	08/10 –	ATE	TP.A-079 TP.A-091	19,0/20,0 18,2			
LR2 (FA_) 2,2 TD4 4x4	10/06 –	ATE	TP.A-079 TP.A-091	19,0/20,0 18,2			
LR2 (FA_) 3,2 4x4	10/06 –	ATE	TP.A-079 TP.A-091	19,0/20,0 18,2			
Range Rover I 3,5 Vogue 4x4	07/70 – 09/90	AP	TP.A-043	18,0			
Range Rover II (LP) 4,0 4x4	06/98 – 03/02	GIR	TP.A-020	17,0			
Rang Rover III (LM) 3,0 TD6, -09/04	03/02	ATE	TP.A-091	18,2			
LOTUS							
Elan 1,6i 16V Turbo	09/89 – 11/95	GM	TP.A-002	14,5			
ELISE 1,8 16v	08/95-11/00	TRW	TP.A-074	18,0			
Esprit S2 2,2 Turbo	02/80 – 08/88				BDX	TP.A-033	14,0
Esprit S4 (082) 2,2 16V Turbo SE	05/89 – 09/96				BDX	TP.A-033	14,0
Excel 2,2 SE / SA	10/84 – 08/91				BDX	TP.A-033	14,0
MAN							
TGA (310, 360, 410, 430, 460, 510 л.с.)	2000 –	KNORR SB 7000	TP.A-115	30,0	KNORR SB 7000	TP.A-115	30,0
TGA (530 л.с.)	2001 –	KNORR SB 7000	TP.A-115	30,0	KNORR SB 7000	TP.A-115	30,0
TGA (280, 326, 480, 660 л.с.)	2002 –	KNORR SB 7000	TP.A-115	30,0	KNORR SB 7000	TP.A-115	30,0
TGA (320, 350, 390, 400, 440 л.с.)	2004 –	KNORR SB 7000	TP.A-115	30,0	KNORR SB 7000	TP.A-115	30,0

Марка автомобиля	Годы выпуска автомобиля	Передние колодки			Задние колодки		
		Тип тормозной системы	№ по каталогу	Толщина изделия, мм	Тип тормозной системы	№ по каталогу	Толщина изделия, мм
MAN							
TGA (540 л.с.)	2006 –	KNORR SB 7000	TP.A-115	30,0	KNORR SB 7000	TP.A-115	30,0
TGM (240, 250, 280, 290, 326 л.с.)	2005 –	KNORR SB 7000	TP.A-115	30,0	KNORR SB 7000	TP.A-115	30,0
TGS (320, 360, 400, 440 л.с.)	2007 –	KNORR SB 7000	TP.A-115	30,0	KNORR SB 7000	TP.A-115	30,0
TGS (441 л.с.)	2011 –	KNORR SB 7000	TP.A-115	30,0	KNORR SB 7000	TP.A-115	30,0
TGX (320, 360, 400, 440, 480 л.с.)	2007 –	KNORR SB 7000	TP.A-115	30,0	KNORR SB 7000	TP.A-115	30,0
MAZDA							
121 1,1i LX	90-10/93	SUM	TP.A-058	15,0			
121 1,3i GLX/Cabrio	90-95	SUM	TP.A-058	15,0			
121 III (JASM, JBSM) 1,25	03/96 – 04/03	ATE	TP.A-009	18,0			
121 III (JASM, JBSM) 1,8 D	03/96 – 04/03	ATE	TP.A-009	18,0			
121 Metro (DW) 1,3i 16V	08/98 – 04/00	SUM	TP.A-058	15,0			
121 Metro Estate (DW) 1,3i 16V	08/98 – 04/00	SUM	TP.A-058	15,0			
323 1,1 LX/L	87-8/89	SUM	TP.A-058	15,0			
323 1,3i	89-	SUM	TP.A-058	15,0			
323 1,3 Sport	87-8/89	SUM	TP.A-058	15,0			
323 1,6i HB LX/GLX Automatic/Sedan LX	6/89-	SUM	TP.A-058	15,0			
323 F 1,6i Coupe LX/GLX/Automatic	6/89-	SUM	TP.A-058	15,0			
323 1,6i Wagon LX/GLX Automatic (ABS)	6/91-	SUM	TP.A-058	15,0			
323 1,7 HB Diesel LX/GLX/Automatic	9/89-	SUM	TP.A-058	15,0			
323 1,7 Sedan DLX/GLX Automatic	6/89-	SUM	TP.A-058	15,0			
323 1,7 Wagon DL/GLX Automatic (ABS)	6/91-	SUM	TP.A-058	15,0			
323 1,8i HB GT 16V	9/89-	SUM	TP.A-058	15,0			
323 1,8i HB Sport (4 WD)	9/89-	SUM	TP.A-058	15,0			
323 F 1,8i 16V Coupe DOH C GT	9/89-	SUM	TP.A-058	15,0			
323 IV Sedan (BG) 1,3 (16V)	09/89 – 07/94	SUM	TP.A-058	15,0			
323 IV Sedan (BG) 1,6 (16V)	08/89 – 10/94	SUM	TP.A-058	15,0			
323 IV Sedan (BG) 1,7 D	09/89 – 07/94	SUM	TP.A-058	15,0			
323 IV Sedan (BG) 1,8 16V (16V Turbo 4WD)	08/89 – 07/94	SUM	TP.A-058	15,0			
323 Astina IV (BG) 1,6 (16V)	09/89 – 10/94	SUM	TP.A-058	15,0			
323 Astina IV (BG) 1,8 16V (16V GT)	08/89 – 07/94	SUM	TP.A-058	15,0			
323 Astina V (BA) 1,3 16V	08/94 – 09/98	SUM	TP.A-058	15,0			
323 Astina V (BA) 1,5 16V	07/94 – 09/98	SUM	TP.A-058	15,0			
323 Astina VI (BJ) 1,4 16V	09/98 – 01/01	SUM	TP.A-058	15,0			

Марка автомобиля	Годы выпуска автомобиля	Передние колодки			Задние колодки		
		Тип тормозной системы	№ по каталогу	Толщина изделия, мм	Тип тормозной системы	№ по каталогу	Толщина изделия, мм
MAZDA							
323 C IV (BG) 1,3 (16V)	09/89 – 07/94	SUM	TP.A-058	15,0			
323 C IV (BG) 1,6 (16V)	09/89 – 10/94	SUM	TP.A-058	15,0			
323 C IV (BG) 1,7 D	08/89 – 07/94	SUM	TP.A-058	15,0			
323 C IV (BG) 1,8 16V 4WD (Turbo 4WD)	09/90 – 12/93	SUM	TP.A-058	15,0			
323 C V (BA) 1,3 16V	08/94 – 09/98	SUM	TP.A-058	15,0			
323 C V (BA) 1,5 16V	08/94 – 09/98	SUM	TP.A-058	15,0			
323 F IV (BG) 1,6 (16V)	09/89 – 10/94	SUM	TP.A-058	15,0			
323 F IV (BG) 1,8 16V (16V GT)	08/89 – 07/94	SUM	TP.A-058	15,0			
323 F V (BA) 1,5 16V	07/94 – 09/98	SUM	TP.A-058	15,0			
323 F VI (BJ) 1,4 16V	09/98 – 01/01	SUM	TP.A-058	15,0			
323 P V (BA) 1,3 16V	10/96 –	SUM	TP.A-058	15,0			
323 P V (BA) 1,5 16V	10/96 –	SUM	TP.A-058	15,0			
323 Protege V (BA) 1,3 16V	08/94 – 09/98	SUM	TP.A-058	15,0			
323 Protege V (BA) 1,5 16V	08/94 – 09/98	SUM	TP.A-058	15,0			
323 Protege V Sedan (BA) 1,3 16V	08/94 – 09/98	SUM	TP.A-058	15,0			
323 Protege V Sedan (BA) 1,5 16V	08/94 – 09/98	SUM	TP.A-058	15,0			
323 S IV (BG) 1,3 (16V)	09/89 – 07/94	SUM	TP.A-058	15,0			
323 S IV (BG) 1,6 (16V)	08/89 – 10/94	SUM	TP.A-058	15,0			
323 S IV (BG) 1,7 D	09/89 – 07/94	SUM	TP.A-058	15,0			
323 S IV (BG) 1,8 16V (16V Turbo 4WD)	08/89 – 07/94	SUM	TP.A-058	15,0			
323 S V (BA) 1,3 16V	08/94 – 09/98	SUM	TP.A-058	15,0			
323 S V (BA) 1,5 16V	08/94 – 09/98	SUM	TP.A-058	15,0			
626 1,8 DX, GLX, LX, Finish	87-	AKB	TP.A-040	15,0			
626 1,8i 16V LX/GLX	2/92-	SUM	TP.A-049	16,5 15,5	SUM	TP.A-064	14,0
626 2,0 12V GLX (ABS)	87-	AKB	TP.A-040	15,0			
626 2,0i GLX	87-	AKB	TP.A-040	15,0			
626 2,0i 16V GLE/GLX/LX	2/92-	SUM	TP.A-049	16,5 15,5	SUM	TP.A-064	14,0
626 2,0i 16V GLE/GLX/LX (ABS)	2/92-	SUM	TP.A-049	16,5 15,5			
626 2,0 LX, GLX	87-	AKB	TP.A-040	15,0			
626 2,2i 12V GLX (ABS)	87-	AKB	TP.A-040	15,0			

Марка автомобиля	Годы выпуска автомобиля	Передние колодки			Задние колодки		
		Тип тормозной системы	№ по каталогу	Толщина изделия, мм	Тип тормозной системы	№ по каталогу	Толщина изделия, мм
MAZDA							
626 2,2i LX (ABS)	87-89	AKB	TP.A-040	15,0			
626 2,0 DLX, GLX	87-	AKB	TP.A-040	15,0			
626 2,5 V6; 24V xerxes	92-	SUM	TP.A-049	16,5 15,5	SUM	TP.A-064	14,0
626 2,0 Diesel Complex LX/GLX	93-	AKB	TP.A-049	16,5 15,5	SUM	TP.A-064	14,0
626 III Break (GV) 1,8	01/88 – 03/92	AKB	TP.A-040	15,0			
626 III Break (GV) 2,0	10/88 – 09/97	AKB	TP.A-040	15,0			
626 III Break (GV) 2,0 12V	09/87 – 01/90	AKB	TP.A-040	15,0			
626 III Break (GV) 2,0 16V	01/88 – 03/92	AKB	TP.A-040	15,0			
626 III Break (GV) 2,0 D	09/88 – 07/91	AKB	TP.A-040	15,0			
626 III Break (GV) 2,2 12V	03/89 – 11/96	AKB	TP.A-040	15,0			
626 III Coupe (GD) 1,8	09/87 – 08/91	AKB	TP.A-040	15,0			
626 III Coupe (GD) 2,0	09/87 – 10/90	AKB	TP.A-040	15,0			
626 III Coupe (GD) 2,0 12V	09/87 – 12/88	AKB	TP.A-040	15,0			
626 III Coupe (GD) 2,0 16V	06/87 – 10/90	AKB	TP.A-040	15,0			
626 III Coupe (GD) 2,2 12V	04/88 – 12/91	AKB	TP.A-040	15,0			
626 III Hatchback (GD) 1,8	11/87 – 05/92	AKB	TP.A-040	15,0			
626 III Hatchback (GD) 2,0	09/87 – 10/90	AKB	TP.A-040	15,0			
626 III Hatchback (GD) 2,0 12V	11/87 – 05/92	AKB	TP.A-040	15,0			
626 III Hatchback (GD) 2,0 16V	06/87 – 08/89	AKB	TP.A-040	15,0			
626 III Hatchback (GD) 2,0 D	07/87 – 07/91	AKB	TP.A-040	15,0			
626 III Hatchback (GD) 2,2 12V	06/88 – 04/92	AKB	TP.A-040	15,0			
626 III Sedan (GD) 1,8	11/87 – 05/92	AKB	TP.A-040	15,0			
626 III Sedan (GD) 2,0	09/87 – 10/90	AKB	TP.A-040	15,0			
626 III Sedan (GD) 2,0 12V	09/87 – 05/92	AKB	TP.A-040	15,0			
626 III Sedan (GD) 2,0 16V	07/87 – 05/92	AKB	TP.A-040	15,0			
626 III Sedan (GD) 2,0 D	07/87 – 07/91	AKB	TP.A-040	15,0			
626 III Sedan (GD) 2,2 12V	11/87 – 07/91	AKB	TP.A-040	15,0			

Марка автомобиля	Годы выпуска автомобиля	Передние колодки			Задние колодки		
		Тип тормозной системы	№ по каталогу	Толщина изделия, мм	Тип тормозной системы	№ по каталогу	Толщина изделия, мм
MAZDA							
626 III Station Wagon (GV) 1,8	01/88 – 03/92	AKB	TP.A-040	15,0			
626 III Station Wagon (GV) 2,0	10/88 – 09/97	AKB	TP.A-040	15,0			
626 III Station Wagon (GV) 2,0 12V	09/87 – 01/90	AKB	TP.A-040	15,0			
626 III Station Wagon (GV) 2,0 16V	01/88 – 03/92	AKB	TP.A-040	15,0			
626 III Station Wagon (GV) 2,0 D	09/88 – 07/91	AKB	TP.A-040	15,0			
626 III Station Wagon (GV) 2,2 12V	03/89 – 11/96	AKB	TP.A-040	15,0			
626 IV Hatchback (GE) 1,8	08/91 – 04/97	SUM	TP.A-049	16,5 15,5	SUM	TP.A-064	14,0
626 IV Hatchback (GE) 2,0 D GLX Complex	01/93 – 04/97	SUM	TP.A-049	16,5 15,5	SUM	TP.A-064	14,0
626 IV Hatchback (GE) 2,0i (4WD)	08/91 – 04/97	SUM	TP.A-049	16,5 15,5	SUM	TP.A-064	14,0
626 IV Hatchback (GE) 2,5 24V	01/92 – 04/97	SUM	TP.A-049	16,5 15,5	SUM	TP.A-064	14,0
626 IV Sedan (GE) 1,8i	01/92 – 04/97	SUM	TP.A-049	16,5 15,5	SUM	TP.A-064	14,0
626 IV Sedan (GE) 2,0 D GLX Complex	10/92 – 04/97	SUM	TP.A-049	16,5 15,5	SUM	TP.A-064	14,0
626 IV Sedan (GE) 2,0i (4WD)	01/92 – 04/97	SUM	TP.A-049	16,5 15,5	SUM	TP.A-064	14,0
626 Combi 2,0i LX, GLX	88-	AKB	TP.A-040	15,0			
626 Combi 2,2i 12V GLX, 4WD	88-	AKB	TP.A-040	15,0			
Astina IV (BG) 1,6 (16V)	09/89 – 10/94	SUM	TP.A-058	15,0			
Astina IV (BG) 1,8 16V (16V GT)	08/89 – 07/94	SUM	TP.A-058	15,0			
Capella III (GD) 1,8	11/87 – 05/92	AKB	TP.A-040	15,0			
Capella III (GD) 2,0	09/87 – 10/90	AKB	TP.A-040	15,0			
Capella III (GD) 2,0 12V	09/87 – 05/92	AKB	TP.A-040	15,0			
Capella III (GD) 2,0 16V	07/87 – 05/92	AKB	TP.A-040	15,0			
Capella III (GD) 2,0 D	07/87 – 07/91	AKB	TP.A-040	15,0			
Capella III (GD) 2,2 12V	11/87 – 07/91	AKB	TP.A-040	15,0			
Capella III Coupe (GD) 1,8	09/87 – 08/91	AKB	TP.A-040	15,0			
Capella III Coupe (GD) 2,0	09/87 – 10/90	AKB	TP.A-040	15,0			
Capella III Coupe (GD) 2,0 12V	09/87 – 12/88	AKB	TP.A-040	15,0			
Capella III Coupe (GD) 2,0 16V	06/87 – 10/90	AKB	TP.A-040	15,0			
Capella III Coupe (GD) 2,2 12V	04/88 – 12/91	AKB	TP.A-040	15,0			

Марка автомобиля	Годы выпуска автомобиля	Передние колодки			Задние колодки		
		Тип тормозной системы	№ по каталогу	Толщина изделия, мм	Тип тормозной системы	№ по каталогу	Толщина изделия, мм
MAZDA							
Capella III Estate (GV) 1,8	01/88 – 03/92	AKB	TP.A-040	15,0			
Capella III Estate (GV) 2,0	10/88 – 09/97	AKB	TP.A-040	15,0			
Capella III Estate (GV) 2,0 12V	09/87 – 01/90	AKB	TP.A-040	15,0			
Capella III Estate (GV) 2,0 16V	01/88 – 03/92	AKB	TP.A-040	15,0			
Capella III Estate (GV) 2,0 D	09/88 – 07/91	AKB	TP.A-040	15,0			
Capella III Estate (GV) 2,2 12V	03/89 – 11/96	AKB	TP.A-040	15,0			
Capella IV (GE) 1,8i	01/92 – 04/97	SUM	TP.A-049	16,5 15,5	SUM	TP.A-064	14,0
Capella IV (GE) 2,0 D GLX Compres	10/92 – 04/97	SUM	TP.A-049	16,5 15,5	SUM	TP.A-064	14,0
Capella IV (GE) 2,0i (4WD)	01/92 – 04/97	SUM	TP.A-049	16,5 15,5	SUM	TP.A-064	14,0
Capella Wagon 1,6-2,0	87-93	AKB	TP.A-040	15,0			
Capella Wagon 2,0 CG 2 SP, CG 2 SR	94	SUM	TP.A-049	16,5			
Clef 2,0 GEEPA, GESRA	92	SUM	TP.A-049	16,5			
Clef 2,5 GE 5 PA	92	SUM	TP.A-049	16,5			
Cranos 1,8-2,5	91 92	SUM	TP.A-049	16,5			
Demio (DW) 1,3i 16V	08/98 – 04/00	SUM	TP.A-058	15,0			
Etude IV (BG) 1,3 (16V)	09/89 – 07/94	SUM	TP.A-058	15,0			
Etude IV (BG) 1,6 (16V)	09/89 – 10/94	SUM	TP.A-058	15,0			
Etude IV (BG) 1,7 D	09/89 – 07/94	SUM	TP.A-058	15,0			
Etude IV (BG) 1,8 16V (4WD / GT / Turbo 4WD)	09/89 – 07/94	SUM	TP.A-058	15,0			
Etude V (BA) 1,3 16V	08/94 – 09/98	SUM	TP.A-058	15,0			
Etude V (BA) 1,5 16V	08/94 – 09/98	SUM	TP.A-058	15,0			
Etude VI (BJ) 1,4 16V	09/98 – 01/01	SUM	TP.A-058	15,0			
Eunos 2,6 Cosma Coupe	93-	SUM	TP.A-049	16,5 15,5	SUM	TP.A-064	14,0
Eunos 4,0 Cosma Coupe	93-	SUM	TP.A-049	16,5 15,5	SUM	TP.A-064	14,0
Eunos 300 1,8 2,0 MA 8 PE	89	AKB	TP.A-040	15,0			
Eunos 500 1,8-2,0	92	SUM	TP.A-049	16,5			
Eunos 500 (CA) 1,6 16V	08/92 – 10/99	SUM	TP.A-049	16,5 15,5	SUM	TP.A-064	14,0

Марка автомобиля	Годы выпуска автомобиля	Передние колодки			Задние колодки		
		Тип тормозной системы	№ по каталогу	Толщина изделия, мм	Тип тормозной системы	№ по каталогу	Толщина изделия, мм
MERCEDES-BENZ							
100 Box D (631.332, 631.342)	02/88 – 05/92	PER	TP.A-034	18,0			
100 Bus D (631.333, 631.343, 631.334, 631.344)	02/88 – 12/94	PER	TP.A-034	18,0			
190 1,8i E (ABS)	88-93	GIR	TP.A-020	17,0	ATE	TP.A-018	13,5
190 2,0i E, Executive (ABS)	82-	GIR	TP.A-020	17,0			
190 2,0i E, Executive (ABS)	82-93				ATE	TP.A-018	13,5
190 2,0i E, Executive (ABS)	82-93	GIR	TP.A-020	17,0	ATE	TP.A-018	13,5
190 2,0 Executive (ABS)	82-93				ATE	TP.A-018	13,5
190 2,0 Executive (ABS)	82-93	GIR	TP.A-020	17,0	ATE	TP.A-018	13,5
190 2,0 Executive (ABS)	82-93	GIR	TP.A-020	17,0			
190 2,3i E 16V E-16 (ABS)	82-93	GIR	TP.A-039	19,5	ATE	TP.A-018	13,5
190 2,3i E, Executive (ABS)	82-93	GIR	TP.A-020	17,0	ATE	TP.A-018	13,5
190 2,5i 16V E-16 (ABS)	87-	GIR	TP.A-039	19,5	ATE	TP.A-018	13,5
190 2,6i E (ABS)	82-	GIR	TP.A-020	17,0	ATE	TP.A-018	13,5
190 2,0 D (ABS)	82-93				ATE	TP.A-018	13,5
190 2,0 D (ABS)	82-93	GIR	TP.A-020	17,0	ATE	TP.A-018	13,5
190 2,0 D (ABS)	82-93	GIR	TP.A-020	17,0			
190 2,5 D (ABS)	82-93	GIR	TP.A-020	17,0	ATE	TP.A-018	13,5
190 2,5 D Turbo (ABS)	82-93	GIR	TP.A-020	17,0	ATE	TP.A-018	13,5
190 Sedan (W 201) 2,0 (201.022, 201.023)	10/82 – 05/90	GIR	TP.A-020	17,0			
190 Sedan (W 201) D 2,0 (201.122)	08/89 – 08/93	GIR	TP.A-020	17,0			
190 Sedan (W 201) D 2,5 (201.126)	04/85 – 08/93	GIR	TP.A-020	17,0			
190 Sedan (W 201) E 1,8 (201.018)	04/90 – 08/93	GIR	TP.A-020	17,0			
190 Sedan (W 201) E 2,0 (201.024)	02/85 – 12/86	GIR	TP.A-020	17,0			
190 Sedan (W 201) E 2,3 (201.028)	10/86 – 08/93	GIR	TP.A-020	17,0			
190 Sedan (W 201) E 2,5-16	09/88 – 08/93	GIR	TP.A-039	19,5	ATE	TP.A-018	13,5
190 Sedan (W 201) E 2,6 (201.029)	09/86 – 08/93	GIR	TP.A-020	17,0			
190 Sedan (W 201) Turbo-D 2,5 (201.128)	02/88 – 08/93	GIR	TP.A-020	17,0			
200 2,0	-76				ATE	TP.A-001	15,0
200 2,0 (ABS)	76-79	ATE	TP.A-006	15,0	ATE	TP.A-001	15,0
200 2,0i E (ABS)	79-85	ATE	TP.A-006	17,5	ATE	TP.A-001	15,0
200 2,0i E (ABS)	87-	GIR	TP.A-039	19,5	ATE	TP.A-018	13,5
200 2,0i T (ABS)	76-79	ATE	TP.A-006	15,0	ATE	TP.A-001	15,0
200 2,0i T (ABS)	79-85	ATE	TP.A-006	17,5	ATE	TP.A-001	15,0
200 2,0i T Executive (ABS)	79-85	ATE	TP.A-006	17,5	ATE	TP.A-001	15,0
200 2,0i T, TE, Executive (ABS)	85-	GIR	TP.A-039	19,5			

Марка автомобиля	Годы выпуска автомобиля	Передние колодки			Задние колодки		
		Тип тормозной системы	№ по каталогу	Толщина изделия, мм	Тип тормозной системы	№ по каталогу	Толщина изделия, мм
MERCEDES-BENZ							
200 2,0i E Executive (ABS)	85-	GIR	TP.A-039	19,5	ATE	TP.A-018	13,5
200 2,0 D (ABS)	76-79	ATE	TP.A-006	15,0	ATE	TP.A-001	15,0
200 2,0 D (ABS)	79-85	ATE	TP.A-006	15,0	ATE	TP.A-001	15,0
200 2,0 D (ABS)	85-	GIR	TP.A-039	19,5	ATE	TP.A-018	13,5
200 2,0 D Turbo (ABS)	85-	GIR	TP.A-039	19,5	ATE	TP.A-018	15,5
200 2,0 D Turbo (ABS)	85-	GIR	TP.A-039	19,5			
200 GE 2,0 Hardtop	82-	PER	TP.A-034	18,0			
207 2,0 D All Models	76-89	PER	TP.A-034	18,0			
207 2,0 D All Models	86-89	PER	TP.A-034	18,0			
207 2,3 D All Models	76-89	PER	TP.A-034	18,0			
207 2,3 D All Models	86-89	PER	TP.A-034	18,0			
207 2,4 D All Models	76-89	PER	TP.A-034	18,0			
207 2,4 D All Models	86-89	PER	TP.A-034	18,0			
208 2,0 D All Models	89-	PER	TP.A-034	18,0			
208 2,3 D All Models	88-	PER	TP.A-034	18,0			
208 2,3 D All Models	89-	PER	TP.A-034	18,0			
208 2,4 D All Models	89-	PER	TP.A-034	18,0			
209 2,9 D All Models	80-89	PER	TP.A-034	18,0			
209 2,9 D All Models	86-89	PER	TP.A-034	18,0			
210 2,3 D All Models	88-	PER	TP.A-034	18,0			
210 3,0 D All Models	89-	PER	TP.A-034	18,0			
220 2,2 TE	92-93	GIR	TP.A-039	19,5			
220 2,2 D (ABS)	76-79	ATE	TP.A-006	15,0	ATE	TP.A-001	15,0
220 2,2 D (ABS)	79-85	ATE	TP.A-006	17,5	ATE	TP.A-001	15,0
220 2,3 C, CE (ABS)	76-79	ATE	TP.A-006	15,0	ATE	TP.A-001	15,0
220 2,3i C, CE (ABS)	76-79	ATE	TP.A-006	15,0	ATE	TP.A-001	15,0
220 2,3i C, CE (ABS)	79-85	ATE	TP.A-006	17,5	ATE	TP.A-001	15,0
230 2,3i CE (ABS)	87-	GIR	TP.A-039	19,5			
230 2,3i CE Executive (ABS)	87-	GIR	TP.A-039	19,5	ATE	TP.A-018	13,5
230 2,3i E (ABS)	85-	GIR	TP.A-039	19,5	ATE	TP.A-018	15,5
230 2,3i T, TE (ABS)	76-79	ATE	TP.A-006	15,0	ATE	TP.A-001	15,0
230 2,3i T, TE (ABS)	79-85	ATE	TP.A-006	17,5	ATE	TP.A-001	15,0
230 2,3i TE Executive (ABS)	85-	GIR	TP.A-039	19,5			
230 2,3 E (ABS)	76-79	ATE	TP.A-006	15,0	ATE	TP.A-001	15,0
230 2,3 E (ABS)	79-85	ATE	TP.A-006	17,5	ATE	TP.A-001	15,0
230 2,3/4 All Models					ATE	TP.A-001	15,0
230 2,3/6 All Models	-76	ATE	TP.A-006	15,0	ATE	TP.A-001	15,0
230 G 2,3 GE, 4x4	79-	PER	TP.A-034	18,0			
230 G 2,3 Hardtop	79-80	PER	TP.A-034	18,0			
230 GE 2,3 Hardtop	82-87	PER	TP.A-034	18,0			
230 GE 2,3i Hardtop	87-	PER	TP.A-034	18,0			

Марка автомобиля	Годы выпуска автомобиля	Передние колодки			Задние колодки		
		Тип тормозной системы	№ по каталогу	Толщина изделия, мм	Тип тормозной системы	№ по каталогу	Толщина изделия, мм
MERCEDES-BENZ							
240 2,4 D	-76				ATE	TP.A-001	15,0
240 2,4 D TD (ABS)	76-79	ATE	TP.A-006	15,0	ATE	TP.A-001	15,0
240 2,4 D TD (ABS)	79-85	ATE	TP.A-006	17,5	ATE	TP.A-001	15,0
240 2,4 D Largo (ABS)	76-79	ATE	TP.A-006	15,0	ATE	TP.A-001	15,0
240 2,4 D Largo (ABS)	79-85	ATE	TP.A-006	17,5	ATE	TP.A-001	15,0
240 3,0 D	-76	ATE	TP.A-006	15,0	ATE	TP.A-001	15,0
240 CD 2,4 D Chasis, Hardtop	79-	PER	TP.A-034	18,0			
240 CD 2,4 D Chasis, Hardtop	79-80	PER	TP.A-034	18,0			
240 CD 2,4 D Chasis, Hardtop, Pick Up	79-87	PER	TP.A-034	18,0			
250 2,5 All Models (ABS)	79-85	ATE	TP.A-006	17,5	ATE	TP.A-001	15,0
250 2,5 L, T (ABS)	76-79	ATE	TP.A-006	15,0	ATE	TP.A-001	15,0
250 2,5 T (ABS)	76-79	ATE	TP.A-006	15,0	ATE	TP.A-001	15,0
250 2,5 T (ABS)	79-85	ATE	TP.A-006	17,5	ATE	TP.A-001	15,0
250 1,5/8 Coupe (ABS)	-76	ATE	TP.A-006	15,0	ATE	TP.A-001	15,0
250 2,5 D (ABS)	85-	GIR	TP.A-039	19,5			
250 2,5 D (ABS)	87-	GIR	TP.A-039	19,5	ATE	TP.A-018	13,5
250 2,5 D Turbo (ABS)	85-	GIR	TP.A-039	19,5			
250 2,5 E/8 (ABS)	-76	ATE	TP.A-006	17,5	ATE	TP.A-001	15,0
250 2,5 TD (ABS)	85-	GIR	TP.A-039	19,5	ATE	TP.A-018	13,5
250 2,5 TD (ABS)	85-	GIR	TP.A-039	19,5			
250 CD 2,5 D Chasis, Hardtop	79-	PER	TP.A-034	18,0			
260 2,6 E	85-89	GIR	TP.A-039	19,5	ATE	TP.A-018	13,5
260 2,6 E, E-Matic 4x4 (ABS)	85-89	GIR	TP.A-039	19,5	ATE	TP.A-018	13,5
260 2,6 E, Largo	85-93	GIR	TP.A-039	19,5			
280 2,7 C, CE	76-79	ATE	TP.A-006	15,0	ATE	TP.A-001	15,0
280 2,7i C, CE TZ	76-79	ATE	TP.A-006	15,0	ATE	TP.A-001	15,0
280 2,7i C, CE TZ (ABS)	79-85	ATE	TP.A-006	17,5	ATE	TP.A-001	15,0
280 2,7i S, SE SEL (ABS)	72-80	ATE	TP.A-006	15,0	ATE	TP.A-001	15,0
280 2,7i SE SEL (ABS)	80-	ATE	TP.A-006	17,5	ATE	TP.A-001	15,0
280 2,7 SL, SLC (ABS)	74-79	ATE	TP.A-006	15,0	ATE	TP.A-001	15,0
280 2,7 SL, SLC (ABS)	79-85	ATE	TP.A-006	17,5	ATE	TP.A-001	15,0
280 2,8 E	76-79	ATE	TP.A-006	15,0	ATE	TP.A-001	15,0
280 2,8 E	79-85	ATE	TP.A-006	17,5	ATE	TP.A-001	15,0
280 2,8 E All Models	76-79	ATE	TP.A-006	15,0	ATE	TP.A-001	15,0
280 2,8 E, SL, SLC (ABS)	79-85	ATE	TP.A-006	17,5	ATE	TP.A-001	15,0
280 2,8 TE	76-79	ATE	TP.A-006	15,0	ATE	TP.A-001	15,0
280 2,8 TE	79-85	ATE	TP.A-006	17,5	ATE	TP.A-001	15,0
280 2,8 TE All Models	76-79	ATE	TP.A-006	15,0	ATE	TP.A-001	15,0
280 GE 2,7i Chasis	82-	PER	TP.A-034	18,0			
280 GE 2,7 Hardtop	79-	PER	TP.A-034	18,0			
290 GD 2,9 All Models	92-96	PER	TP.A-034	18,0			

Марка автомобиля	Годы выпуска автомобиля	Передние колодки			Задние колодки		
		Тип тормозной системы	№ по каталогу	Толщина изделия, мм	Тип тормозной системы	№ по каталогу	Толщина изделия, мм
MERCEDES-BENZ							
300 2,3i E-24 (ABS)	89-93	ATE	TP.A-006	17,5	ATE	TP.A-018	15,5
300 2,3i E-24 (ABS)	89-93	GIR	TP.A-039	19,5	ATE	TP.A-018	15,5
300 3,0i CE, SE, SEL (ABS)	87-	GIR	TP.A-039	19,5	ATE	TP.A-018	13,5
300 3,0i CE-24 (ABS)	87-	GIR	TP.A-039	19,5			
300 3,0i E, E4-Matic 4x4, E4 (ABS)	85-	GIR	TP.A-039	19,5	ATE	TP.A-018	15,5
300 3,0i SE, SEL (ABS)	80-	ATE	TP.A-006	17,5	ATE	TP.A-001	15,0
300 3,0i SL (ABS)	74-79	ATE	TP.A-006	15,0	ATE	TP.A-001	15,0
300 3,0i SL (ABS)	79-85	ATE	TP.A-006	17,5	ATE	TP.A-001	15,0
300 3,0i SL (ABS)	85-				ATE	TP.A-001	15,0
300 3,0i TE 4-Matic (ABS)	85-	GIR	TP.A-039	19,5			
300 3,0-24 (ABS)	85-	GIR	TP.A-039	19,5			
300 3,0 D 4-Matic 4x4 (ABS)	85-	GIR	TP.A-039	19,5	ATE	TP.A-018	13,5
300 3,0 D Turbo, 4x4 (ABS)	85-	GIR	TP.A-039	19,5	ATE	TP.A-018	13,5
300 3,0 D, CD Turbo (ABS)	76-79	ATE	TP.A-006	15,0	ATE	TP.A-001	15,0
300 3,0 D, CD Turbo (ABS)	79-85	ATE	TP.A-006	17,5	ATE	TP.A-001	15,0
300 3,0 D, Turbo Largo (ABS)	76-79	ATE	TP.A-006	15,0	ATE	TP.A-001	15,0
300 3,0 D, Turbo Largo (ABS)	79-85	ATE	TP.A-006	17,5	ATE	TP.A-001	15,0
300 3,0 TD (ABS)	85-	GIR	TP.A-039	19,5			
300 3,0 TD, 4-Matic, 4x4 (ABS)	85-	GIR	TP.A-039	19,5			
300 GD 3,0 Chasis, Hardtop, Pick Up	79-80	PER	TP.A-034	18,0			
300 GE 3,0i Chasia, Hardtop, Pick Up	90-	PER	TP.A-034	18,0			
307 2,0 D All Models	80-88	PER	TP.A-034	18,0			
307 2,4 D All Models	80-88	PER	TP.A-034	18,0			
308 2,3 All Models	80-88	PER	TP.A-034	18,0			
308 2,3 D All Models	88-	PER	TP.A-034	18,0			
308 3,0 D All Models	88-	PER	TP.A-034	18,0			
309 2,9 D All Models	80-88	PER	TP.A-034	18,0			
310 2,3 All Models	88-	PER	TP.A-034	18,0			
320 GE 3,2 All Models	93-	PER	TP.A-034	18,0			
350 3,5i SE, SEL	72-80	ATE	TP.A-006	15,0	ATE	TP.A-001	15,0
350 3,5i SL, SLC	74-79	ATE	TP.A-006	15,0	ATE	TP.A-001	15,0
350 3,5i SL, SLC	79-85	ATE	TP.A-006	17,5	ATE	TP.A-001	15,0
350 3,5i SL, SLC	85-				ATE	TP.A-001	15,0
350G 3,0 All Models	96-	PER	TP.A-034	18,0			
350G 3,4 All Models	93-96	PER	TP.A-034	18,0			
380 3,8i SE, SEL (ABS)	80-	ATE	TP.A-006	17,5	ATE	TP.A-001	15,0
380 3,0i SEC (ABS)	81-85				ATE	TP.A-001	15,0
380 3,0i SEC (ABS)	85-	ATE	TP.A-006	17,5	ATE	TP.A-001	15,0
380 3,8i SL, SLC	74-79	ATE	TP.A-006	15,0	ATE	TP.A-001	15,0
380 3,8i SL, SLC	79-85	ATE	TP.A-006	17,5	ATE	TP.A-001	15,0
420 4,2i SE, SEL (ABS)	80-	ATE	TP.A-006	17,5	ATE	TP.A-001	15,0

Марка автомобиля	Годы выпуска автомобиля	Передние колодки			Задние колодки		
		Тип тормозной системы	№ по каталогу	Толщина изделия, мм	Тип тормозной системы	№ по каталогу	Толщина изделия, мм
MERCEDES-BENZ							
E300 3,0	93-95	GIR	TP.A-039	19,5	ATE	TP.A-018	15,5
E300 3,0 T	93-96	GIR	TP.A-039	19,5			
E300 3,0 D, TD	93-95	GIR	TP.A-039	19,5	ATE	TP.A-018	15,5
E320 3,2 T (ABS)	93-96	GIR	TP.A-039	19,5			
MB 65/70	73-	ATE	TP.A-006	15,0	ATE	TP.A-006	15,0
MB 100 2,4 D	88-91	PER	TP.A-034	18,0			
MB 700, 800, 900, Turbo	76-	ATE	TP.A-006	15,0	ATE	TP.A-006	15,0
Actros (313, 354, 394, 428, 476, 530 л.с.)	1996 – 2002	KNORR SB 7000	TP.A-115	30,0	KNORR SB 7000	TP.A-115	30,0
Actros (313, 354, 394, 428, 456, 476, 571 л.с.)	1997 – 2002	KNORR SB 7000	TP.A-115	30,0	KNORR SB 7000	TP.A-115	30,0
Actros MP2 / MP3 (578 л.с.)	2002 –	KNORR SB 7000	TP.A-115	30,0	KNORR SB 7000	TP.A-115	30,0
Actros MP2 / MP3 (312, 313, 320, 354, 360, 394 л.с.)	2003 –	KNORR SB 7000	TP.A-115	30,0	KNORR SB 7000	TP.A-115	30,0
Actros MP2 / MP3 (401, 408, 428, 435, 456, 476 л.с.)	2003 –	KNORR SB 7000	TP.A-115	30,0	KNORR SB 7000	TP.A-115	30,0
Actros MP2 / MP3 (503, 510, 530, 537, 551, 598, 653 л.с.)	2003 –	KNORR SB 7000	TP.A-115	30,0	KNORR SB 7000	TP.A-115	30,0
Atego (231, 279 л.с.)	1998 – 2004	KNORR SB 7000	TP.A-115	30,0	KNORR SB 7000	TP.A-115	30,0
Axor (231, 279, 354, 401, 428 л.с.)	2002 – 2004	KNORR SB 7000	TP.A-115	30,0	KNORR SB 7000	TP.A-115	30,0
Axor 2 (231, 256, 279, 286, 326, 360 л.с.)	2004 –	KNORR SB 7000	TP.A-115	30,0	KNORR SB 7000	TP.A-115	30,0
Axor 2 (354, 401 л.с.)	2004 – 2005	KNORR SB 7000	TP.A-115	30,0	KNORR SB 7000	TP.A-115	30,0
Axor 2 (400 л.с.)	2009 –	KNORR SB 7000	TP.A-115	30,0	KNORR SB 7000	TP.A-115	30,0
Axor 2 (305 л.с.)	2011 –	KNORR SB 7000	TP.A-115	30,0	KNORR SB 7000	TP.A-115	30,0
B-Class (W 245) 1,5	03/05-				TRW	TP.A-110	14,3
B-Class (W 245) 1,7	03/05-				TRW	TP.A-110	14,3
B-Class (W 245) 2,0	03/05-				TRW	TP.A-110	14,3
B-Class (W 245) 2,0 CDI	03/05-				TRW	TP.A-110	14,3
B-Class (W 245) 1,6	04/09 – 11/11				TRW	TP.A-110	14,3
B-Class (W 245) 1,7 NGT	04/08 – 11/11				TRW	TP.A-110	14,3
B-Class (W 245) 1,8	04/09 – 11/11				TRW	TP.A-110	14,3
B-Class (W 245) 1,8 CDI	03/05 – 11/11				TRW	TP.A-110	14,3
B-Class (W 245) 1,8 NGT	04/08 – 11/11				TRW	TP.A-110	14,3
B-Class (W 245) 2,0 Turbo	03/05 – 11/11				TRW	TP.A-110	14,3

Марка автомобиля	Годы выпуска автомобиля	Передние колодки			Задние колодки		
		Тип тормозной системы	№ по каталогу	Толщина изделия, мм	Тип тормозной системы	№ по каталогу	Толщина изделия, мм
MERCEDES-BENZ							
C-Class Break (S 202) C 180 T (202.078, 202.081)	06/96 – 03/01	GIR	TP.A-046	20,0			
C-Class Break (S 202) C 200 T (202.080)	06/96 – 03/01	GIR	TP.A-046	20,0			
C-Class Break (S 202) C 200 T CDI (202.194)	03/98 – 03/01	GIR	TP.A-046	20,0			
C-Class Break (S 202) C 200 TD (202.180)	10/96 – 03/01	GIR	TP.A-046	20,0			
C-Class Break (S 202) C 220 T CDI (202.193)	09/97 – 03/01	GIR	TP.A-046	20,0			
C-Class Break (S 202) C 220 TD (202.182)	06/96 – 03/01	GIR	TP.A-046	20,0			
C-Class Break (S 202) C 230 T (202.083)	06/96 – 06/98	GIR	TP.A-046	20,0	ATE	TP.A-018	15,5
C-Class Estate (S 202) C 180 T (202.078, 202.081)	06/96 – 03/01	GIR	TP.A-046	20,0			
C-Class Estate (S 202) C 200 T (202.080)	06/96 – 03/01	GIR	TP.A-046	20,0			
C-Class Estate (S 202) C 200 T CDI (202.194)	03/98 – 03/01	GIR	TP.A-046	20,0			
C-Class Estate (S 202) C 200 TD (202.180)	10/96 – 03/01	GIR	TP.A-046	20,0			
C-Class Estate (S 202) C 220 T CDI (202.193)	09/97 – 03/01	GIR	TP.A-046	20,0			
C-Class Estate (S 202) C 220 TD (202.182)	06/96 – 09/98	GIR	TP.A-046	20,0			
C-Class Estate (S 202) C 230 T (202.083)	06/96 – 06/98	GIR	TP.A-046	20,0	ATE	TP.A-018	15,5
C-Class Sedan (W 202) C 180 (202.018)	03/93 – 05/00	GIR	TP.A-046	20,0	ATE	TP.A-018	15,5
C-Class Sedan (W 202) C 200 (202.020)	01/94 – 05/00	GIR	TP.A-046	20,0	ATE	TP.A-018	15,5
C-Class Sedan (W 202) C 200 CDI (202.134)	03/98 – 05/00	GIR	TP.A-046	20,0			
C-Class Sedan (W 202) C 200 D (202.120, 202.122)	03/93 – 05/00	GIR	TP.A-046	20,0	ATE	TP.A-018	15,5
C-Class Sedan (W 202) C 220 (202.022)	03/93 – 05/00	GIR	TP.A-046	20,0	ATE	TP.A-018	15,5
C-Class Sedan (W 202) C 220 CDI (202.133)	09/97 – 05/00	GIR	TP.A-046	20,0			
C-Class Sedan (W 202) C 220 D (202.121)	08/93 – 05/00	GIR	TP.A-046	20,0	ATE	TP.A-018	15,5
C-Class Sedan (W 202) C 230 (202.023)	06/96 – 06/97	GIR	TP.A-046	20,0			
C-Class Sedan (W 202) C 250 D (202.125)	05/93 – 05/00	GIR	TP.A-046	20,0	ATE	TP.A-018	15,5
C-Class Sedan (W 202) C 280 (202.028)	05/93 – 05/00	GIR	TP.A-046	20,0	ATE	TP.A-018	15,5
Citro (O 530) (231, 279, 299, 354 л.с.)	1998 –	KNORR SB 7000	TP.A-115	30,0	KNORR SB 7000	TP.A-115	30,0
Citro (O 530) (177, 245 л.с.)	1999 –	KNORR SB 7000	TP.A-115	30,0	KNORR SB 7000	TP.A-115	30,0
Citro (O 530) (252, 326 л.с.)	2000 –	KNORR SB 7000	TP.A-115	30,0	KNORR SB 7000	TP.A-115	30,0
Conecto (O 345) (214, 252, 279, 299, 354 л.с.)	2001 –	KNORR SB 7000	TP.A-115	30,0	KNORR SB 7000	TP.A-115	30,0

Марка автомобиля	Годы выпуска автомобиля	Передние колодки			Задние колодки		
		Тип тормозной системы	№ по каталогу	Толщина изделия, мм	Тип тормозной системы	№ по каталогу	Толщина изделия, мм
MERCEDES-BENZ							
Coupe (C 124) 220 CE (124.042)	10/92 – 05/93	GIR	TP.A-039	19,5	ATE	TP.A-018	15,5
Coupe (C 124) 230 CE (124.043)	03/87 – 12/92	GIR	TP.A-039	19,5	ATE	TP.A-018	15,5
Coupe (C 124) 230 CE (124.043) KAT	06/89 – 12/92	GIR	TP.A-039	19,5	ATE	TP.A-018	15,5
Coupe (C 124) 300 CE (124.050)	03/87 – 05/93	GIR	TP.A-039	19,5	ATE	TP.A-018	15,5
E-Class Break (S 124) E 200 T (124.079)	06/93 – 06/96	GIR	TP.A-039	19,5			
E-Class Break (S 124) E 220 T (124.082)	06/93 – 06/96	GIR	TP.A-039	19,5			
E-Class Break (S 124) E 250 TD (124.186)	06/93 – 06/96	GIR	TP.A-039	19,5	ATE	TP.A-018	15,5
E-Class Break (S 124) E 280 T (124.088)	06/93 – 06/96	GIR	TP.A-039	19,5			
E-Class Break (S 124) E 300 T 4-matic (124.290)	06/93 – 06/96	GIR	TP.A-039	19,5			
E-Class Break (S 124) E 300 TD (124.191)	06/93 – 06/96	GIR	TP.A-039	19,5			
E-Class Break (S 124) E 300 T Turbo-D (124.193)	06/93 – 06/96	GIR	TP.A-039	19,5			
E-Class Break (S 124) E 300 T Turbo-D 4-matic (124.393)	06/93 – 06/96	GIR	TP.A-039	19,5			
E-Class Convertible (A 124) E 200 (124.060)	06/93 – 03/98	GIR	TP.A-039	19,5			
E-Class Convertible (A 124) E 220 (124.062)	06/93 – 03/98	GIR	TP.A-039	19,5			
E-Class Coupe (C 124) E 200 (124.040)	06/93 – 06/97	GIR	TP.A-039	19,5	ATE	TP.A-018	15,5
E-Class Coupe (C 124) E 220 (124.042)	06/93 – 06/97	GIR	TP.A-039	19,5	ATE	TP.A-018	15,5
E-Class Estate (S 124) E 200 T (124.079)	06/93 – 06/96	GIR	TP.A-039	19,5			
E-Class Estate (S 124) E 220 T (124.082)	06/93 – 06/96	GIR	TP.A-039	19,5			
E-Class Estate (S 124) E 250 TD (124.186)	06/93 – 06/96	GIR	TP.A-039	19,5	ATE	TP.A-018	15,5
E-Class Estate (S 124) E 250 Turbo-D (124.128)	06/93 – 06/96	GIR	TP.A-039	19,5			
E-Class Estate (S 124) E 280 T (124.088)	06/93 – 06/96	GIR	TP.A-039	19,5			
E-Class Estate (S 124) E 300 4-matic (124.290)	06/93 – 06/96	GIR	TP.A-039	19,5			
E-Class Estate (S 124) E 300 TD (124.191)	06/93 – 06/96	GIR	TP.A-039	19,5			
E-Class Estate (S 124) E 300 T Turbo-D (124.193)	06/93 – 06/96	GIR	TP.A-039	19,5			
E-Class Estate (S 124) E 300 T Turbo-D 4-matic (124.393)	06/93 – 06/96	GIR	TP.A-039	19,5			
E-Class Sedan (W 124) E 200 (124.019)	06/93 – 06/95	GIR	TP.A-039	19,5	ATE	TP.A-018	15,5
E-Class Sedan (W 124) E 200 D (124.120)	06/93 – 06/95	GIR	TP.A-039	19,5	ATE	TP.A-018	15,5

Марка автомобиля	Годы выпуска автомобиля	Передние колодки			Задние колодки		
		Тип тормозной системы	№ по каталогу	Толщина изделия, мм	Тип тормозной системы	№ по каталогу	Толщина изделия, мм
MERCEDES-BENZ							
E-Class Sedan (W 124) E 220 (124.022)	06/93 – 06/95	GIR	TP.A-039	19,5	ATE	TP.A-018	15,5
E-Class Sedan (W 124) E 250 D (124.126, 124.129)	07/93 – 06/95	GIR	TP.A-039	19,5	ATE	TP.A-018	15,5
E-Class Sedan (W 124) E 250 Turbo-D (124.128)	06/93 – 06/95	GIR	TP.A-039	19,5	ATE	TP.A-018	15,5
E-Class Sedan (W 124) E 280 (124.028, 124.029)	06/93 – 06/95	GIR	TP.A-039	19,5	ATE	TP.A-018	15,5
E-Class Sedan (W 124) E 300 4-matic (124.230)	06/93 – 06/95	GIR	TP.A-039	19,5	ATE	TP.A-018	15,5
E-Class Sedan (W 124) E 300 D (124.131)	07/93 – 06/95	GIR	TP.A-039	19,5	ATE	TP.A-018	15,5
E-Class Sedan (W 124) E 300 Turbo-D (124.133)	06/93 – 06/95	GIR	TP.A-039	19,5	ATE	TP.A-018	15,5
E-Class Sedan (W 124) E 300 Turbo-D 4-matic (124.333)	06/93 – 06/95	GIR	TP.A-039	19,5	ATE	TP.A-018	15,5
Econic (231, 238, 279 л.с.)	1998 –	KNORR SB 7000	TP.A-115	30,0	KNORR SB 7000	TP.A-115	30,0
Econic (279 л.с.)	2000 –	KNORR SB 7000	TP.A-115	30,0	KNORR SB 7000	TP.A-115	30,0
Econic (286 л.с.)	2001 –	KNORR SB 7000	TP.A-115	30,0	KNORR SB 7000	TP.A-115	30,0
G-Class (W 461) G 280 CDI	04/09 –	PER	TP.A-034	18,0			
G-Class (W 461) G 300 CDI	04/10 –	PER	TP.A-034	18,0			
G-Class (W 463) G 350 CDI	07/11 –	PER	TP.A-034	18,0			
G-Class (W 463) G 400 CDI (463.332, 463.333)	12/00 –	PER	TP.A-034	18,0			
G-Class (W 463) G 500	05/08 –	PER	TP.A-034	18,0			
G-Class (W 463) G 55 AMG (463.243, 463.246)	04/99 –	PER	TP.A-034	18,0			
G-Class (W 463) G 55 AMG (463.270, 463.271)	06/04 –	PER	TP.A-034	18,0			
G-Class (W 463) G 63 AMG	05/12 –	PER	TP.A-034	18,0			
G-Class Cabrio (W 463) 230 GE (463.204)	06/90 – 02/93	PER	TP.A-034	18,0			
G-Class Cabrio (W 463) 300 GD (463.307)	12/90 – 09/97	PER	TP.A-034	18,0			
G-Class Cabrio (W 463) 300 GE (463.207)	09/89 – 09/97	PER	TP.A-034	18,0			
G-Class Cabrio (W 463) 320 GE (463.208)	09/94 – 11/97	PER	TP.A-034	18,0			
G-Class Cabrio (W 463) 350 G Turbo-D (463.300)	09/91 – 09/97	PER	TP.A-034	18,0			
G-Class Cabrio (W 463) G 300 TD (463.308)	09/96 –	PER	TP.A-034	18,0			
G-Class Cabrio (W 463) G 320 (463.209)	11/97 –	PER	TP.A-034	18,0			
G-Class Cabrio (W 463) G 320 CDI	09/06 –	PER	TP.A-034	18,0			
G-Class Cabrio (W 463) G 350 CDI	07/11 –	PER	TP.A-034	18,0			
G-Class Cabrio (W 463) G 400 CDI (463.309)	12/00 –	PER	TP.A-034	18,0			
G-Class Cabrio (W 463) G 500	12/09 –	PER	TP.A-034	18,0			
Integro (O 550) (286, 299, 300, 354, 408 л.с.)	2006 –	KNORR SB 7000	TP.A-115	30,0	KNORR SB 7000	TP.A-115	30,0

Марка автомобиля	Годы выпуска автомобиля	Передние колодки			Задние колодки		
		Тип тормозной системы	№ по каталогу	Толщина изделия, мм	Тип тормозной системы	№ по каталогу	Толщина изделия, мм
MERCEDES-BENZ							
Intouro (286, 299, 354, 408 л.с.)	2005 –	KNORR SB 7000	TP.A-115	30,0	KNORR SB 7000	TP.A-115	30,0
Kombi Break (S 124) 200 T (124.080)	01/86 – 05/90	GIR	TP.A-039	19,5			
Kombi Break (S 124) 200 TD (124.180)	09/85 – 08/91	GIR	TP.A-039	19,5			
Kombi Break (S 124) 200 TE (124.079, 124.081)	09/88 – 08/92	GIR	TP.A-039	19,5			
Kombi Break (S 124) 220 TE (124.082)	10/92 – 05/93	GIR	TP.A-039	19,5			
Kombi Break (S 124) 230 TE (124.083)	09/85 – 08/92	GIR	TP.A-039	19,5			
Kombi Break (S 124) 230 TE (124.083) KAT	06/89 – 08/92	GIR	TP.A-039	19,5			
Kombi Break (S 124) 250 TD (124.185)	09/85 – 06/93	GIR	TP.A-039	19,5			
Kombi Break (S 124) 250 TD Turbo (124.188)	03/88 – 07/93	GIR	TP.A-039	19,5			
Kombi Break (S 124) 260 TE FGST	09/85 – 08/92	GIR	TP.A-039	19,5			
Kombi Break (S 124) 280 TE (124.088)	10/92 – 06/93	GIR	TP.A-039	19,5			
Kombi Break (S 124) 300 TD (124.190)	09/86 – 06/93	GIR	TP.A-039	19,5			
Kombi Break (S 124) 300 T Turbo-D (124.193)	01/89 – 06/93	GIR	TP.A-039	19,5			
Kombi Break (S 124) 300 T Turbo-D 4-matic (124.393)	09/86 – 06/93	GIR	TP.A-039	19,5			
Kombi Break (S 124) 300 TE (124.090)	01/86 – 08/92	GIR	TP.A-039	19,5	ATE	TP.A-018	15,5
Kombi Break (S 124) 300 TE 4-matic (124.290)	09/86 – 06/93	GIR	TP.A-039	19,5			
Kombi Estate (S 124) 200 T (124.080)	09/85 – 05/90	GIR	TP.A-039	19,5			
Kombi Estate (S 124) 200 TD (124.180)	09/85 – 08/91	GIR	TP.A-039	19,5			
Kombi Estate (S 124) 200 TE (124.079, 124.081)	09/88 – 06/93	GIR	TP.A-039	19,5			
Kombi Estate (S 124) 220 TE (124.082)	10/92 – 05/93	GIR	TP.A-039	19,5			
Kombi Estate (S 124) 230 TE (124.083)	09/85 – 08/92	GIR	TP.A-039	19,5			
Kombi Estate (S 124) 230 TE (124.083) KAT	06/89 – 08/92	GIR	TP.A-039	19,5			
Kombi Estate (S 124) 250 TD (124.185)	09/85 – 06/93	GIR	TP.A-039	19,5			
Kombi Estate (S 124) 250 TD Turbo (124.188)	03/88 – 07/93	GIR	TP.A-039	19,5			
Kombi Estate (S 124) 260 TE FGST	09/85 – 08/92	GIR	TP.A-039	19,5			
Kombi Estate (S 124) 280 TE (124.088)	10/92 – 06/93	GIR	TP.A-039	19,5			
Kombi Estate (S 124) 300 TD (124.190)	09/86 – 06/93	GIR	TP.A-039	19,5			
Kombi Estate (S 124) 300 T Turbo-D (124.193)	09/86 – 06/93	GIR	TP.A-039	19,5			

Марка автомобиля	Годы выпуска автомобиля	Передние колодки			Задние колодки		
		Тип тормозной системы	№ по каталогу	Толщина изделия, мм	Тип тормозной системы	№ по каталогу	Толщина изделия, мм
MERCEDES-BENZ							
Kombi Estate (S 124) 300 T Turbo-D 4-matic (124.393)	09/86 – 06/93	GIR	TP.A-039	19,5			
Kombi Estate (S 124) 300 TE (124.090)	01/86 – 08/92	GIR	TP.A-039	19,5	ATE	TP.A-018	15,5
Kombi Estate (S 124) 300 TE 4-matic (124.290)	09/86 – 06/93	GIR	TP.A-039	19,5			
МК (245, 272, 313, 330, 340 л.с.)	1987 – 1996	KNORR SB 7000	TP.A-115	30,0	KNORR SB 7000	TP.A-115	30,0
NG (216 л.с.)	1981 – 1990	KNORR SB 7000	TP.A-115	30,0	KNORR SB 7000	TP.A-115	30,0
NG (280, 330, 354, 375, 435 л.с.)	1973 – 1996	KNORR SB 7000	TP.A-115	30,0	KNORR SB 7000	TP.A-115	30,0
NG (355 л.с.)	1981 – 1991	KNORR SB 7000	TP.A-115	30,0	KNORR SB 7000	TP.A-115	30,0
O 100 (95 л.с.)	1994 –	KNORR SB 7000	TP.A-115	30,0	KNORR SB 7000	TP.A-115	30,0
O 403 (354, 422 л.с.)	2003 –	KNORR SB 7000	TP.A-115	30,0	KNORR SB 7000	TP.A-115	30,0
OF Series (137, 170, 210 л.с.)	1983 –	KNORR SB 7000	TP.A-115	30,0	KNORR SB 7000	TP.A-115	30,0
OH Series (156, 177, 193, 204, 216, 218, 245, 250, 256, 265, 280 л.с.)	1970 –	KNORR SB 7000	TP.A-115	30,0	KNORR SB 7000	TP.A-115	30,0
S-Class (W 126) 260 SE (126.020)	09/85 – 06/91	GIR	TP.A-039	19,5	ATE	TP.A-001 TP.A-018	15,0 15,5
S-Class (W 126) 300 SE, SEL (126.024, 126.025)	09/85 – 06/91	GIR	TP.A-039	19,5	ATE	TP.A-001 TP.A-018	15,0 15,5
S-Class (W 126) 420 SE, SEL (126.034)	10/85 – 06/91				ATE	TP.A-001	15,0
S-Class (W 126) 500 SE, SEL (126.036)	09/85 – 06/91				ATE	TP.A-001	15,0
S-Class (W 126) 560 SE, SEL (126.038)	10/85 – 06/91				ATE	TP.A-001	15,0
S-Class Coupe (C 126) 420 SEC (126.046)	10/85 – 06/91				ATE	TP.A-001	15,0
S-Class Coupe (C 126) 500 SEC (126.044)	10/81 – 06/91				ATE	TP.A-001	15,0
S-Class Coupe (C 126) 560 SEC (126.045)	10/85 – 06/91				ATE	TP.A-001	15,0
S-Class Sedan (W 126) 260 SE (126.020)	09/85 – 06/91	GIR	TP.A-039	19,5	ATE	TP.A-001 TP.A-018	15,0 15,5
S-Class Sedan (W 126) 300 SE, SEL (126.024, 126.025)	09/85 – 06/91	GIR	TP.A-039	19,5	ATE	TP.A-001 TP.A-018	15,0 15,5
S-Class Sedan (W 126) 420 SE, SEL (126.034)	10/85 – 06/91				ATE	TP.A-001	15,0
S-Class Sedan (W 126) 500 SE, SEL (126.036)	09/85 – 06/91				ATE	TP.A-001	15,0
S-Class Sedan (W 126) 560 SE, SEL (126.038)	10/85 – 06/91				ATE	TP.A-001	15,0
Sedan (W 124) 200 (124.020)	12/85 – 05/90				ATE	TP.A-018	15,5
Sedan (W 124) 200 D (124.120)	12/84 – 06/93				ATE	TP.A-018	15,5
Sedan (W 124) 200 E (124.019, 124.021)	09/88 – 06/93				ATE	TP.A-018	15,5

Марка автомобиля	Годы выпуска автомобиля	Передние колодки			Задние колодки		
		Тип тормозной системы	№ по каталогу	Толщина изделия, мм	Тип тормозной системы	№ по каталогу	Толщина изделия, мм
MERCEDES-BENZ							
Sedan (W 124) 220 E (124.022)	10/92 – 06/93				ATE	TP.A-018	15,5
Sedan (W 124) 230 E (124.023)	12/84 – 06/93				ATE	TP.A-018	15,5
Sedan (W 124) 250 D (124.125)	04/85 – 06/93				ATE	TP.A-018	15,5
Sedan (W 124) 250 Turbo-D (124.128)	09/88 – 06/93				ATE	TP.A-018	15,5
Sedan (W 124) 260 E (124.026)	09/85 – 08/92				ATE	TP.A-018	15,5
Sedan (W 124) 300 D (124.130)	12/84 – 06/93				ATE	TP.A-018	15,5
Sedan (W 124) 300 D 4-matic (124.330)	09/86 – 06/93				ATE	TP.A-018	15,5
Sedan (W 124) 300 E (124.030)	08/85 – 08/92				ATE	TP.A-018	15,5
Sedan (W 124) 300 E 4-matic (124.230)	09/86 – 06/93				ATE	TP.A-018	15,5
Sedan (W 124) 300 Turbo-D (124.133)	09/86 – 06/93				ATE	TP.A-018	15,5
Sedan (W 124) 300 Turbo-D 4-matic (124.333)	09/86 – 06/93				ATE	TP.A-018	15,5
SK (447, 480 л.с.)	1988 – 1992	KNORR SB 7000	TP.A-115	30,0	KNORR SB 7000	TP.A-115	30,0
SK (366 л.с.)	1988 – 1993	KNORR SB 7000	TP.A-115	30,0	KNORR SB 7000	TP.A-115	30,0
SK (286, 462 л.с.)	1988 – 1994	KNORR SB 7000	TP.A-115	30,0	KNORR SB 7000	TP.A-115	30,0
SK (354, 381, 435 л.с.)	1987 – 1996	KNORR SB 7000	TP.A-115	30,0	KNORR SB 7000	TP.A-115	30,0
SK (492, 503 л.с.)	1991 – 1996	KNORR SB 7000	TP.A-115	30,0	KNORR SB 7000	TP.A-115	30,0
SK (530 л.с.)	1994 – 1996	KNORR SB 7000	TP.A-115	30,0	KNORR SB 7000	TP.A-115	30,0
Sprinter 3-t Box (903) 308 CDI	04/00 – 05/06	PE	TP.A-083	23,0			
Sprinter 3-t Box (903) 313 CDI (CDI 4x4)	04/00 – 05/06	PE	TP.A-083	23,0			
Sprinter 3-t Bus (903) 308 CDI	04/00 – 05/06	PE	TP.A-083	23,0			
Sprinter 3-t Bus (903) 313 CDI (CDI 4x4)	04/00 – 05/06	PE	TP.A-083	23,0			
Sprinter 3-t Flatbed/Chassis (903) 2,1 311 CDI	04/00-05/06	PE	TP.A-083	20,0			
Sprinter 3-t Flatbed/Chassis (903) 2,1 311 CDI 4x4	08/02-05/06	PE	TP.A-083	20,0			
Sprinter 3-t Flatbed/Chassis (903) 2,3 314, 01/00-	02/95-05/06	PE	TP.A-083	20,0			
Sprinter 3-t Flatbed/Chassis (903) 2,3 314 4x4	08/02-05/06	PE	TP.A-083	20,0			
Sprinter 3-t Flatbed/Chassis (903) 2,7 316 CDI	04/00-05/06	PE	TP.A-083	20,0			
Sprinter 3-t Flatbed/Chassis (903) 2,7 316 CDI 4x4	08/02-05/06	PE	TP.A-083	20,0			

Марка автомобиля	Годы выпуска автомобиля	Передние колодки			Задние колодки		
		Тип тормозной системы	№ по каталогу	Толщина изделия, мм	Тип тормозной системы	№ по каталогу	Толщина изделия, мм
MERCEDES-BENZ							
Sprinter 4-t Box (904) 408 CDI / D	02/96 – 05/06	PE	TP.A-083	23,0			
Sprinter 4-t Box (904) 410 D (D 4x4)	02/96 – 05/06	PE	TP.A-083	23,0			
Sprinter 4-t Box (904) 412 D (D 4x4)	02/96 – 05/06	PE	TP.A-083	23,0			
Sprinter 4-t Box (904) 413 CDI	04/00 – 05/06	PE	TP.A-083	23,0			
Sprinter 4-t Box (904) 414 (4x4)	02/96 – 05/06	PE	TP.A-083	23,0			
Sprinter 4-t Bus (904) 408 CDI	04/00 – 05/06	PE	TP.A-083	23,0			
Sprinter 4-t Bus (904) 414	02/96 – 05/06	PE	TP.A-083	23,0			
Sprinter 4-t Bus (904) 416 CDI	04/00 – 05/06	PE	TP.A-083	23,0			
Sprinter 4,6-t Box (906) 2,1 416 CDI	03/09-	PE	TP.A-083	20,0			
Sprinter 4,6-t Box (906) 3,0 419 CDI	03/09-	PE	TP.A-083	20,0			
Sprinter 4,6-t Box (906) 3,5 424	06/06-	PE	TP.A-083	20,0			
Sprinter 4,6-t Flatbed/Chassis (906) 3,5 424	06/06-	PE	TP.A-083	20,0			
Sprinter 4-t Box (904) 2,1 408 CDI	04/00-05/06	PE	TP.A-083	20,0			
Sprinter 4-t Flatbed/Chassis (904) 2,1 408 CDI	04/00-05/06	PE	TP.A-083	20,0			
Sprinter 4-t Flatbed/Chassis (904) 2,1 413 CDI	04/00-05/06	PE	TP.A-083	20,0			
Sprinter 4-t Flatbed/Chassis (904) 2,3 414, -04/01	02/96-05/06	PE	TP.A-083	20,0			
Sprinter 4-t Flatbed/Chassis (904) 2,3 414 4x4, 01/00-04/01	05/97-05/06	PE	TP.A-083	20,0			
Sprinter 4-t Flatbed/Chassis (904) 2,3 408 D, -12/99	02/96-05/06	PE	TP.A-083	20,0			
Sprinter 4-t Flatbed/Chassis (904) 2,3 408 D 4x4	06/97-12/99	PE	TP.A-083	20,0			
Sprinter 4-t Flatbed/Chassis (904) 2,9 410 D, 01/97-08/00	02/96-05/06	PE	TP.A-083	20,0			
Sprinter 4-t Flatbed/Chassis (904) 2,9 410 D 4x4, -12/99	05/97-05/06	PE	TP.A-083	20,0			
Sprinter 4-t Flatbed/Chassis (904) 2,9 412 D, -08/00	02/96-05/06	PE	TP.A-083	20,0			
Sprinter 4-t Flatbed/Chassis (904) 2,9 412 D 4x4, -07/00	05/97-05/06	PE	TP.A-083	20,0			
Sprinter 2-t Box (901, 902) 2,1 208 CDI	04/00-05/06	PE	TP.A-083	20,0			
Sprinter 2-t Box (901, 902) 2,1 211 CDi	04/00-05/06	PE	TP.A-083	20,0			
Sprinter 2-t Box (901, 902) 2,1 213 CDi	04/00-05/06	PE	TP.A-083	20,0			
Sprinter 2-t Box (901, 902) 2,3 214	02/95-05/06	PE	TP.A-083	20,0			

Марка автомобиля	Годы выпуска автомобиля	Передние колодки			Задние колодки		
		Тип тормозной системы	№ по каталогу	Толщина изделия, мм	Тип тормозной системы	№ по каталогу	Толщина изделия, мм
MERCEDES-BENZ							
Sprinter 2-t Box (901, 902) 2,3 214 N6T	04/00-05/06	PE	TP.A-083	20,0			
Sprinter 2-t Box (901, 902) 2,3 208 D	02/95-04/00	PE	TP.A-083	20,0			
Sprinter 2-t Box (901, 902) 2,7 216 CDI	04/00-05/06	PE	TP.A-083	20,0			
Sprinter 2-t Bus (901, 902) 2,9 210 D	03/97-04/00	PE	TP.A-083	20,0			
Sprinter 2-t Bus (901, 902) 2,9 212 D	02/95-04/00	PE	TP.A-083	20,0			
Sprinter 2-t Flatbed/Chassis (901, 902) 2,3 214, -01/00	02/95-05/06	PE	TP.A-083	20,0			
Sprinter 3-t Box 2,1 311 CDi 4x4	08/02-05/06	PE	TP.A-083	20,0			
Sprinter 3-t Box 2,3 314 4x4	08/02-05/06	PE	TP.A-083	20,0			
Sprinter 3-t Box 2,7 316 CDI	04/00-05/06	PE	TP.A-083	20,0			
Sprinter 3-t Box 2,7 316 CDI 4X4	08/02-05/06	PE	TP.A-083	20,0			
Sprinter 3-t Bus (903) 2,1 311 D	04/00-05/06	PE	TP.A-083	20,0			
Sprinter 3-t Bus (903) 2,1 311 SDI 4x4	08/02-05/06	PE	TP.A-083	20,0			
Sprinter 3-t Bus (903) 2,3 314 4x4	08/02-05/06	PE	TP.A-083	20,0			
Sprinter 3-t Bus (903) 2,7 316 SDI	04/00-05/06	PE	TP.A-083	20,0			
Sprinter 3-t Bus (903) 2,7 316 SDI 4x4	08/02-05/06	PE	TP.A-083	20,0			
T1 Box (601) 207 D 2,4	06/82 – 01/90	PER	TP.A-034	18,0			
T1 Box (601) 209 D 2,9	12/82 – 01/90	PER	TP.A-034	18,0			
T1 Box (602) 307 D 2,4	10/82 – 01/90	PER	TP.A-034	18,0			
T1 Box (602) 308 D 2,3	11/88 – 02/96	PER	TP.A-034	18,0			
T1 Box (602) 309 D 3,0	10/82 – 01/90	PER	TP.A-034	18,0			
T1 Box (602) 310 D 2,9	06/89 – 02/96	PER	TP.A-034	18,0			
T1 Bus (601) 207 D 2,4	05/77 – 01/90	PER	TP.A-034	18,0			
T1 Bus (601) 208 2,3	05/77 – 12/82	PER	TP.A-034	18,0			
T1 Bus (601) 209 D 2,9	12/82 – 01/90	PER	TP.A-034	18,0			
T1 Bus (602) 308 D 2,3	06/89 – 02/96	PER	TP.A-034	18,0			
T1 Bus (602) 310 D 2,9	06/89 – 02/96	PER	TP.A-034	18,0			

Марка автомобиля	Годы выпуска автомобиля	Передние колодки			Задние колодки		
		Тип тормозной системы	№ по каталогу	Толщина изделия, мм	Тип тормозной системы	№ по каталогу	Толщина изделия, мм
MITSUBISHI							
3000 GT 3,0i 24V 4WD (Z16A)	06/92 – 08/99	AKE	TP.A-063	15,7			
Airtrek I (CU5W)	05/03 – 10/06	AKE	TP.A-063	15,7			
Airtrek I 2,4 4WD (CU5W)	05/03 – 10/06	AKE	TP.A-063	15,7			
Aspire VI 2,0 (EA2A)	09/96 – 09/00	AKE	TP.A-063	15,7			
Aspire VI 2,4 GDI (EA3A)	02/99 – 09/00	AKE	TP.A-063	15,7			
Aspire VI 2,5 V6 24V (EA5A)	09/96 – 09/00	AKE	TP.A-063	15,7			
Challenger (K90) (PA) 2,5 TD (K94W)	11/98 –	AKE	TP.A-063	15,7			
Challenger (K90) (PA) 3,0 V6 (K96W)	11/98 –	AKE	TP.A-063	15,7			
Chariot 1,8-2,0	84-91	AKE	TP.A-053	15,5			
Chariot 2,0-2,4 (EX, N43)	91	SUM	TP.A-055	16,4			
Colt 1,3 EL/CL	5/92-	SUM	TP.A-054	15,0			
Colt 1,3 EL/CL (C51)	90-4/92	AKE	TP.A-053	15,5			
Colt 1,3 EL/CL (C51/MNM)	88-4/90	AKE	TP.A-053	15,5			
Colt 1,3 GLXE	90-4/92	SUM	TP.A-054	15,0			
Colt 1,5i GLi (C52/MFN)	88-4/92	AKE	TP.A-053	15,5			
Colt 1,5i GLXi/GLXi EXE	5/92-	SUM	TP.A-054	15,0			
Colt 1,5i GLi (C52/MNM)	88-4/92	AKE	TP.A-053	15,5			
Colt 1,5i GLi	5/92-	SUM	TP.A-054	15,0			
Colt 1,5i GLi Automatic (C52)	88-4/92	AKE	TP.A-053	15,5			
Colt 1,5i GLi Automatic	5/92-	SUM	TP.A-054	15,0			
Colt 1,6i GLX 4 cyl	93-	SUM	TP.A-054	15,0			
Colt 1,6i GTi 16V	88-4/92	AKE	TP.A-053	15,5			
Colt 1,6i Turbo ECi	84-8/88	AKE	TP.A-053	15,5			
Colt 1,6i Turbo (c 13A), 1,8D (c 14 A)	84-88	AKE	TP.A-053	15,5			
Colt 1,8 GTi 16V (C58)	89-92	SUM	TP.A-055	16,4			
Colt 1.8 Diesel GL/EL	88-6/90	AKE	TP.A-053	15,5			
Colt 1.8 Wagon Diesel	88-6/88	AKE	TP.A-053	15,5			
Colt 1,8i 16V GT: (140HP)	5/92	SUM	TP.A-054	15,0			
Colt IV 1,3 GLi 12V (CA1A)	04/92 – 04/96	SUM	TP.A-054	15,0			
Colt IV 1,6 GLXi 16V (CA4A)	02/94 – 04/96	SUM	TP.A-054	15,0			
Colt IV 1,6 4WD (CC4A)	08/93 – 08/95	SUM	TP.A-054	15,0			
Colt V 1300 (GL / GLX) (CJ1A)	05/96 – 09/03	SUM	TP.A-054	15,0			
Colt V 1500 (CJ2A)	11/95 – 09/03	SUM	TP.A-054	15,0			
Colt V 1600 (GLX) (CJ4A)	05/96 – 09/03	SUM	TP.A-054	15,0			
Colt / Rodeo 2,4 4WD (K75T)	06/96 – 12/07	AKE	TP.A-063	15,7			

Марка автомобиля	Годы выпуска автомобиля	Передние колодки			Задние колодки		
		Тип тормозной системы	№ по каталогу	Толщина изделия, мм	Тип тормозной системы	№ по каталогу	Толщина изделия, мм
mitsubishi							
Galant 1,6 (E11), 1,8 Saloon (E32A), 1,8D	85-88	AKE	TP.A-053	15,5			
Galant 1,6 (E11), 1,8 Saloon (E32A), 1,8D	88-91	AKE	TP.A-053	15,5			
Galant 1,6 EL/GL/GLX (E11)	84-5/-88	AKE	TP.A-053	15,5			
Galant 1,6 GL (E31)	6/90-	SUM	TP.A-053	15,0			
Galant 1,6 L/GL (E31)	88-5/90	AKE	TP.A-053	15,5			
Galant 1,6 Wagon GLX (E11)	84-5/-88	AKE	TP.A-053	15,5			
Galant 1,8 EL/GL/GLS (E32)	88-5/90	AKE	TP.A-053	15,5			
Galant 1,8 GLX-E (E32)	88-5/90	AKE	TP.A-053	15,5			
Galant 1,8 Turbo Diesel	84-4/90	AKE	TP.A-053	15,5			
Galant 1,8i GLSi (ABS)	90-1/93	SUM	TP.A-054	15,0			
Galant 1,8 (T31)	90	SUM	TP.A-054	15,0			
Galant 2,0 (E15)	85-88	AKE	TP.A-053	15,5			
Galant 2,0 (E33)	88-91	AKE	TP.A-053	15,5			
Galant 2,0 Hatchback	89-2/91	AKE	TP.A-053	15,5			
Galant 2,0 Turbo GSR	84-5/88	AKE	TP.A-053	15,5			
Galant 2,0i 16v (E33A)	88-90	AKE	TP.A-053	15,5			
Galant 2,0gti (kp.4WD) (E33A)	88-90	AKE	TP.A-053	15,5			
Galant 2,0i GLSi (E33)	6/88-	AKE	TP.A-053	15,5			
Galant 2,0i GLSi 4WD	89-4/90	AKE	TP.A-053	15,5			
Galant 2,0i GLSi 4WD/4WS	6/90-	SUM	TP.A-054	15,0			
Galant 2,0i GLXi/GLi Hatchback	88-5/90	AKE	TP.A-053	15,5			
Galant 2,0i 16V GTi 4WD/4WS	6/90-	SUM	TP.A-054	15,0			
Galant 2,0i 16V GTi 4WD/4WS	89-5/90	AKE	TP.A-053	15,5			
Galant 2,0i Turbo Eci	84-5/88	AKE	TP.A-053	15,5			
Galant Z 1,8-3,0	86-90	SUM	TP.A-055	16,4			
Galant (Sumi)	92	SUM	TP.A-055	16,4			
Galant III Sedan 1,6 GLX (E11A)	06/84 – 04/90	AKE	TP.A-053	15,5			
Galant III Sedan 1,8 Turbo-D (E14A)	06/84 – 04/90	AKE	TP.A-053	15,5			
Galant III Sedan 2,0 GLS (Turbo ECi) (E15A)	06/84 – 04/90	AKE	TP.A-053	15,5			
Galant III Sedan 2,4 GLS (E16A)	07/85 – 04/90	AKE	TP.A-053	15,5			
Galant IV 1,8 (E32A)	11/88 – 10/92	AKE	TP.A-053	15,5			
Galant IV 1,8 Turbo-D (E34A)	11/88 – 10/92	AKE	TP.A-053	15,5			
Galant IV 2,0 (4WD) (E39A, E38A, E33A)	04/89 – 10/92	AKE	TP.A-053	15,5			
Galant IV 2,0 GTi 16V 4WD (E39A, E38A, E33A)	11/88 – 12/92	AKE	TP.A-053 TP.A-063	15,5 15,7			
Galant IV Sedan 1,8 (E32A)	11/87 – 10/92	AKE	TP.A-053	15,5			
Galant IV Sedan 1,8 Turbo-D (E34A)	12/87 – 10/92	AKE	TP.A-053	15,5			

Марка автомобиля	Годы выпуска автомобиля	Передние колодки			Задние колодки		
		Тип тормозной системы	№ по каталогу	Толщина изделия, мм	Тип тормозной системы	№ по каталогу	Толщина изделия, мм
mitsubishi							
Galant IV Sedan 2,0 (4WD) (E39A, E38A, E33A)	11/87 – 10/92	AKE	TP.A-053	15,5			
Galant IV Sedan 2,0 GTi 16V 4WD (E39A, E38A, E33A) KAT	11/88 – 12/92	AKE	TP.A-053 TP.A-063	15,5 15,7			
Galant V 2,5 V6-24 4WD (E88A)	11/92 – 08/96	AKE	TP.A-063	15,7			
Galant V Sedan 2,5 V6-24 4WD (E88A)	11/92 – 08/96	AKE	TP.A-063	15,7			
Galant VI 2,0 (EA2A)	09/96 – 09/00	AKE	TP.A-063	15,7			
Galant VI 2,4 GDI (EA3A)	02/99 – 09/00	AKE	TP.A-063	15,7			
Galant VI 2,5 V6 24V (EA5A)	09/96 – 09/00	AKE	TP.A-063	15,7			
Galant VI Estate 2,0 (EA2W)	09/96 – 10/03	AKE	TP.A-063	15,7			
Galant VI Estate 2,4 GDI (EA3W)	02/99 – 10/03	AKE	TP.A-063	15,7			
Galant VI Estate 2,5 V6 24V (EA5W)	09/96 – 09/00	AKE	TP.A-063	15,7			
Galant VI Sedan 2,0 (EA2A)	09/96 – 09/00	AKE	TP.A-063	15,7			
Galant VI Sedan 2,4 GDI (EA3A)	02/99 – 09/00	AKE	TP.A-063	15,7			
Galant VI Sedan 2,5 V6 24V (EA5A)	09/96 – 09/00	AKE	TP.A-063	15,7			
Galant Fortis Sedan 2,0 EVO (CZ4A)	06/08 –	AKE	TP.A-063	15,7			
Lancer 1,3 EL/GL	88-1/92	AKE	TP.A-053	15,5			
Lancer 1,3 EL/GL/GLXi Sedan							
Station Wagon 4 cyl 12V	2/92-	SUM	TP.A-054	15,0			
Lancer 1,5i GLi/GLXi	88-1/92	AKE	TP.A-053	15,5			
Lancer 1,5 GLi/GLXi	2/92-	SUM	TP.A-054	15,0			
Lancer 1,5 (C62)	90-92	SUM	TP.A-054	15,0			
Lancer 1,6 GTi (C63)	88-90	AKE	TP.A-053	15,5			
Lancer 1,6i GTi (ABS)	88-8/92	AKE	TP.A-053	15,5			
Lancer 1,6i Turbo Eci	84-3/85	AKE	TP.A-053	15,5			
Lancer 1,6i GLX; 4cyl 16V	91-7/93	SUM	TP.A-054	15,0			
Lancer 1,6i 16V	91-7/93	SUM	TP.A-054	15,0			
Lancer 1,8D (C14A)	84-88	AKE	TP.A-053	15,5			
Lancer 1,8D (C54)	90-92	SUM	TP.A-054	15,0			
Lancer 1,8 (D)	81-8/84	AKE	TP.A-053	15,5			
Lancer 1,8WD (C77)	90-92	SUM	TP.A-054	15,0			
Lancer 1,8WDGL (ABS)	87-8/88	AKE	TP.A-053	15,5			
Lancer 1,8 Diesel/Diesel ELD	84-1/92	AKE	TP.A-053	15,5			
Lancer ELD Sedan	2/92	SUM	TP.A-054	15,0			
Lancer 1,8 GLD all models	2/92	SUM	TP.A-054	15,0			
Lancer 1,8 4WD Wagon	87-6/90	AKE	TP.A-053	15,5			
Lancer 1,8 Wagon Diesel GLD	88-1/92	AKE	TP.A-053	15,5			
Lancer 1,8 Wagon Diesel	85-8/88	AKE	TP.A-053	15,5			
Lancer 1,8i 4WD GLXi	88-1/92	AKE	TP.A-053	15,5			
Lancer 1,8i DTi 16V Hatchback	2/92-	SUM	TP.A-054	15,0			

Марка автомобиля	Годы выпуска автомобиля	Передние колодки			Задние колодки		
		Тип тормозной системы	№ по каталогу	Толщина изделия, мм	Тип тормозной системы	№ по каталогу	Толщина изделия, мм
mitsubishi							
Lancer 1,8 Station Wagon 16V	1/94	SUM	TP.A-054	15,0			
Lancer 2,0 Turbo Diesel	95-	SUM	TP.A-054	15,0			
Lancer III Break 1,5 (C12V)	09/88 – 12/91	AKE SUM	TP.A-053 TP.A-054	15,5 15,0			
Lancer III Break 1,8 4WD (C37V)	01/87 – 06/92	AKE SUM	TP.A-053 TP.A-054	15,5 15,0			
Lancer III Break 1,8 D (C14V)	09/85 – 06/92	AKE SUM	TP.A-053 TP.A-054	15,5 15,0			
Lancer IV Sedan 1,3 (12V) (C61A)	04/88 – 06/92	AKE SUM	TP.A-053 TP.A-054	15,5 15,0			
Lancer IV Sedan 1,5 (12V) (C62A)	04/88 – 05/92	AKE SUM	TP.A-053 TP.A-054	15,5 15,0			
Lancer IV Sedan 1,8 GLX Diesel (C64A)	04/88 – 05/92	AKE SUM	TP.A-053 TP.A-054	15,5 15,0			
Lancer V 1,3 (CB1A)	06/92 – 12/96	SUM	TP.A-054	15,0			
Lancer V 1,6 (16V) (CB4A)	06/92 – 12/96	SUM	TP.A-054	15,0			
Lancer V 1,6 16V 4WD (CD4A)	06/92 – 12/96	SUM	TP.A-054	15,0			
Lancer V 2,0 Diesel (CB8A)	06/92 – 12/96	SUM	TP.A-054	15,0			
Lancer V 2,0 EVO (II, III) (CE9A)	01/94 – 07/96	SUM	TP.A-054	15,0			
Lancer V Break 1,6 16V (CB4W)	12/92 – 10/03	SUM	TP.A-054	15,0			
Lancer V Break 1,6 16V 4WD (CD4W)	12/92 – 10/03	SUM	TP.A-054	15,0			
Lancer V Break 2,0 D (CB8W)	12/92 – 10/03	SUM	TP.A-054	15,0			
Lancer V Estate 1,6 16V (CB4W)	12/92 – 10/03	SUM	TP.A-054	15,0			
Lancer V Estate 1,6 16V 4WD (CD4W)	12/92 – 10/03	SUM	TP.A-054	15,0			
Lancer V Estate 2,0 D (CB8W)	12/92 – 10/03	SUM	TP.A-054	15,0			
Lancer V Sedan 1,3 (CB1A)	06/92 – 12/96	SUM	TP.A-054	15,0			
Lancer V Sedan 1,6 (16V) (CB4A)	06/92 – 12/96	SUM	TP.A-054	15,0			
Lancer V Sedan 1,6 16V 4WD (CD4A)	06/92 – 12/96	SUM	TP.A-054	15,0			
Lancer V Sedan 2,0 Diesel (CB8A)	06/92 – 12/96	SUM	TP.A-054	15,0			
Lancer V Sedan 2,0 EVO (II, III) (CE9A)	01/94 – 07/96	SUM	TP.A-054	15,0			
Lancer V Station Wagon 1,6 16V (CB4W)	12/92 – 10/03	SUM	TP.A-054	15,0			
Lancer V Station Wagon 1,6 16V 4WD (CD4W)	12/92 – 10/03	SUM	TP.A-054	15,0			
Lancer V Station Wagon 2,0 D (CB8W)	12/92 – 10/03	SUM	TP.A-054	15,0			
Lancer VI 1,3 12V (CK1A)	12/95 – 08/03	SUM	TP.A-054	15,0			

Марка автомобиля	Годы выпуска автомобиля	Передние колодки			Задние колодки		
		Тип тормозной системы	№ по каталогу	Толщина изделия, мм	Тип тормозной системы	№ по каталогу	Толщина изделия, мм
MITSUBISHI							
Lancer VI 1,5 16V (CK2A)	12/95 – 08/03	SUM	TP.A-054	15,0			
Lancer VI 1,6 16V (CK4A)	12/95 – 08/03	SUM	TP.A-054	15,0			
Lancer VI Sedan 1,3 12V (CK1A)	12/95 – 08/03	SUM	TP.A-054	15,0			
Lancer VI Sedan 1,5 16V (CK2A)	12/95 – 08/03	SUM	TP.A-054	15,0			
Lancer VI Sedan 1,6 16V (CK4A)	12/95 – 08/03	SUM	TP.A-054	15,0			
Lancer EX Sedan (2,0) EVO (CZ4A)	06/08 –	AKE	TP.A-063	15,7			
Lancer Fortis Sedan (2,0) EVO (CZ4A)	06/08 –	AKE	TP.A-063	15,7			
Lancer Serie R Sedan (2,0) EVO (CZ4A)	06/08 –	AKE	TP.A-063	15,7			
Legnum VI Estate 2,0 (EA2W)	09/00 – 10/03	AKE	TP.A-063	15,7			
Legnum VI Estate 2,4 GDI (EA3W)	02/99 – 10/03	AKE	TP.A-063	15,7			
Legnum VI Estate 2,5 V6 24V (EA5W)	09/96 – 09/00	AKE	TP.A-063	15,7			
Libero V 1,3 (CB1A)	06/92 – 12/96	SUM	TP.A-054	15,0			
Libero V 1,6 (16V) (CB4A)	06/92 – 12/96	SUM	TP.A-054	15,0			
Libero V 1,6 16V 4WD (CD4A)	06/92 – 12/96	SUM	TP.A-054	15,0			
Libero V 2,0 Diesel (CB8A)	06/92 – 12/96	SUM	TP.A-054	15,0			
Libero V 2,0 EVO (II / III) (CE9A)	01/94 – 07/96	SUM	TP.A-054	15,0			
Libero V Estate 1,6 16V (CB4W)	12/92 – 10/03	SUM	TP.A-054	15,0			
Libero V Estate 1,6 16V 4WD (CD4W)	12/92 – 10/03	SUM	TP.A-054	15,0			
Libero V Estate 2,0 D (CB8W)	12/92 – 10/03	SUM	TP.A-054	15,0			
Libero Cargo 1,3-1,8 (EX CD5W)	92	SUM	TP.A-054	15,0			
Libero Cargo 2,0 (EX CD8W)	92	SUM	TP.A-054	15,0			
L200 1,6 Pickup (LO21P)	87	SUM	TP.A-055	16,4			
L200 2,0 WD, 4WD Pickup (K121T)	87	SUM	TP.A-055	16,4			
L200 2,5 Diesel 2WD (K14T), 4WD (R24T)	87	SUM	TP.A-055	16,4			
L 200 2,4 4WD (K75T)	06/96 – 12/07	AKE	TP.A-063	15,7			
L 200 2,5 TD 4WD (K34T, K74T)	11/92 – 12/07	AKE	TP.A-063	15,7			
L 200 2,6 4WD (K33T)	11/89 – 05/95	SUM	TP.A-055	16,4			
L300 1,6 Van (LO62)	83-87	SUM	TP.A-055	16,4			

Марка автомобиля	Годы выпуска автомобиля	Передние колодки			Задние колодки		
		Тип тормозной системы	№ по каталогу	Толщина изделия, мм	Тип тормозной системы	№ по каталогу	Толщина изделия, мм
mitsubishi							
L300 1,6 Van (P02, P12)	83-87	SUM	TP.A-055	16,4			
L300 2,0 (P03, P13)	84	SUM	TP.A-055	16,4			
L300 2,5 Diesel Van (P05, P15)	87	SUM	TP.A-055	16,4			
L 300 Bus 1,6 (L032P, L062P, P12V, P02V)	11/84 –	SUM	TP.A-055	16,4			
L 300 Bus 2,4 (P04W, P14V, P04V)	11/90 –	SUM	TP.A-055	16,4			
L 300 Bus 2,4 4WD (P24W, P24V)	11/86 –	SUM	TP.A-055	16,4			
L 300 Express Van 1,6 (P12V, P02V)	11/86 – 05/94	SUM	TP.A-055	16,4			
L 300 Express Van 2,0 (P03V, P13V)	11/86 –	SUM	TP.A-055	16,4			
L 300 Express Van 2,5 D (P05V, P05W, P15V)	11/86 – 02/06	SUM	TP.A-055	16,4			
L 300 Express Van 2,5 TD 4WD	11/91 – 05/03	SUM	TP.A-055	16,4			
L 300 Starwagon Bus 1,6 (P02V, P12V)	11/86 –	SUM	TP.A-055	16,4			
L 300 Starwagon Bus 2,0 (4WD) (P13V, P23V, P23W, P03V, P03W, P13T)	11/86 –	SUM	TP.A-055	16,4			
L 300 Starwagon Bus 2,0i (P13V, P00W, P03V, P03W, P13T)	07/96 –	SUM	TP.A-055	16,4			
L 300 Starwagon Bus 2,4 (P04W, P14V, P04V)	11/90 –	SUM	TP.A-055	16,4			
L 300 Starwagon Bus 2,4 4WD (P24W, P24V)	11/86 –	SUM	TP.A-055	16,4			
L 300 Starwagon Bus 2,5 D (P25V, P25W, P05W, P05V, P15V, P15T)	11/86 –	SUM	TP.A-055	16,4			
L 400 / Space Gear Bus 2,0 16V (PA3V/W, PB3V)	05/95 – 05/00	AKE	TP.A-063	15,7			
L 400 / Space Gear Bus 2,4i 4WD (PD4V/W)	05/95 –	AKE	TP.A-063	15,7			
L 400 / Space Gear Bus 2,5 TD (4WD) (PA5V/W, PD5V/W, PB5V)	05/95 – 05/00	AKE	TP.A-063	15,7			
L 400 Van 2500 TD 4WD (PD5W, PD5V, PA5W, PA5V)	09/96 – 06/05	AKE	TP.A-063	15,7			
Minica 0,6i all models	93-	SUM	TP.A-054	15,0			
Mirage 2DR/4DR/ABS	93-	SUM	TP.A-054	15,0			
Mirage	91-92	SUM	TP.A-054	15,0			
Mirage	89-90	AKE	TP.A-053	15,5			
Mirage	89-90	AKE	TP.A-053	15,5			
Mirage	89-	AKE	TP.A-053	15,5			
Mirage 1,3-1,5	91	SUM	TP.A-054	15,0			
Mirage 1,6 CA, CB	90	SUM	TP.A-055	16,4			
Mirage 1,6 C53A, C63A	89-91	SUM	TP.A-055	16,4			
Mirage 1,4 Turbo (A152A)	82-83	AKE	TP.A-053	15,5			
Mirage V 1300 (GL / GLX) (CJ1A)	05/96 – 09/03	SUM	TP.A-054	15,0			
Mirage V 1500 (CJ2A)	11/95 – 09/03	SUM	TP.A-054	15,0			
Mirage V 1600 (GLX) (CJ4A)	05/96 – 09/03	SUM	TP.A-054	15,0			

Марка автомобиля	Годы выпуска автомобиля	Передние колодки			Задние колодки		
		Тип тормозной системы	№ по каталогу	Толщина изделия, мм	Тип тормозной системы	№ по каталогу	Толщина изделия, мм
mitsubishi							
Montero 2,5 TDi GL	90-	AKE	TP.A-063	15,7			
Montero 2,8 TDi GLS (ABS)	93-	AKE	TP.A-063	15,7			
Montero 3,0i	91-	AKE	TP.A-063	15,7			
Montero 3,5	93-	AKE	TP.A-063	15,7			
Montero 2,5 TD (L044G, L049G)	01/90 – 12/91	SUM	TP.A-055	16,4			
Montero 3,0 V6 (L141G, L146G)	11/88 – 11/90	SUM	TP.A-055	16,4			
Montero II 2,4 (V21W, V21C)	04/91 – 10/99	AKE	TP.A-063	15,7			
Montero II TD (V46W)	06/94 – 10/99	AKE	TP.A-063	15,7			
Montero II V6 24V (V25W, V45W)	06/94 – 10/99	AKE	TP.A-063	15,7			
Montero III 2,5 TDi (V7_W, V6_W)	04/00 – 12/06	AKE	TP.A-063	15,7			
Montero Sport (K90) 2,5 TD (K94W)	11/98 –	AKE	TP.A-063	15,7			
Montero Sport (K90) 3,0 V6 (K96W)	11/98 –	AKE	TP.A-063	15,7			
Nimbus 1,8 TD (D09V, D09W)	06/86 – 04/91	AKE	TP.A-053	15,5			
Nimbus 2,0 4WD (GLX 4WD) (D08W)	03/85 – 04/91	AKE	TP.A-053	15,5			
Nimbus 2,0 GLX (GLXi) (D04W)	06/86 – 04/91	AKE	TP.A-053	15,5			
Outlander I 2,4 4WD (CU5W)	05/03 – 10/06	AKE	TP.A-063	15,7			
Outlander II 2,2 DI-D 4WD	08/07 –	AKE	TP.A-063	15,7			
Pajero I Canvas Top 2,5 TD (L044G, L049G)	05/86 – 10/89	SUM	TP.A-055	16,4			
Pajero I Canvas Top 2,6 (L042G, L047G)	01/83 – 11/90	SUM	TP.A-055	16,4			
Pajero II 2,4 (V21W, V21C)	04/91 – 10/99	AKE	TP.A-063	15,7			
Pajero II 2,5 TD 4WD (V24C, V24W)	12/90 – 10/99	AKE	TP.A-063	15,7			
Pajero II 2,8 TD (V46W)	06/94 – 10/99	AKE	TP.A-063	15,7			
Pajero II 3,0 V6 24V (4WD) (V43W, V23W, V23C)	06/94 – 10/99	AKE	TP.A-063	15,7			
Pajero II 3,5 V6 24V (V25W, V45W)	06/94 – 10/99	AKE	TP.A-063	15,7			
Pajero II Canvas Top 1,8 GDI	06/98 – 04/00	AKE	TP.A-063	15,7			
Pajero II Canvas Top 2,4 (V41W, V21W, V21C)	04/91 – 04/00	AKE	TP.A-063	15,7			
Pajero II Canvas Top 2,5 TD 4WD (V24C, V24W)	12/90 – 04/00	AKE	TP.A-063	15,7			
Pajero II Canvas Top 3,0 V6 (24V) (V23W, V43W, V23C)	12/90 – 04/00	AKE	TP.A-063	15,7			
Pajero III 2,5 TDi (V7_W, V6_W)	09/01 – 12/06	AKE	TP.A-063	15,7			
Pajero III Canvas Top 2,5 TDi (V64W, V74W)	09/01 – 12/06	AKE	TP.A-063	15,7			

Марка автомобиля	Годы выпуска автомобиля	Передние колодки			Задние колодки		
		Тип тормозной системы	№ по каталогу	Толщина изделия, мм	Тип тормозной системы	№ по каталогу	Толщина изделия, мм
mitsubishi							
Pajero SFX II 2,4 (V21W, V21C)	04/91 – 10/99	AKE	TP.A-063	15,7			
Pajero SFX II 2,5 TD 4WD (V24C, V24W)	12/90 – 10/99	AKE	TP.A-063	15,7			
Pajero SFX II 2,8 TD (V46W)	06/94 – 10/99	AKE	TP.A-063	15,7			
Pajero SFX II 3,0 V6 24V (4WD) (V43W, V23W, V23C)	06/94 – 10/99	AKE	TP.A-063	15,7			
Pajero SFX II 3,5 V6 24V (V25W, V45W)	06/94 – 10/99	AKE	TP.A-063	15,7			
Pajero Sport (K90) 2,5 TD (K94W)	11/98 –	AKE	TP.A-063	15,7			
Pajero Sport (K90) 3,0 V6 (K96W)	11/98 –	AKE	TP.A-063	15,7			
Pajero / Shogun 2,5 TD (L044G, L049G)	11/89 – 12/91	SUM AKE	TP.A-055 TP.A-063	16,4 15,7			
Pajero / Shogun 3,0 V6 (L141G, L146G)	11/88 – 11/90	SUM	TP.A-055	16,4			
Pajero / Shogun II 2,4 (V21W, V21C)	04/91 – 10/99	AKE	TP.A-063	15,7			
Pajero / Shogun II 2,5 TD 4WD (V24C, V24W)	12/90 – 10/99	AKE	TP.A-063	15,7			
Pajero / Shogun II 2,8 TD (V46W)	06/94 – 10/99	AKE	TP.A-063	15,7			
Pajero / Shogun II 3,0 V6 24V (V43W, V23W, V23C)	12/90 – 10/99	AKE	TP.A-063	15,7			
Pajero / Shogun II 3,5 V6 24V (V25W, V45W)	06/94 – 10/99	AKE	TP.A-063	15,7			
Pajero / Shogun III 2,5 TDi (V7_W, V6_W)	04/00 – 12/06	AKE	TP.A-063	15,7			
RVR 1,8-2,0	91	SUM	TP.A-055	16,4			
Sapporo 1,6 GLX (A161)	82-2/86	AKE	TP.A-053	15,5			
Sapporo 2,0 Automatic GSL (A164)	84-2/86	AKE	TP.A-053	15,5			
Sapporo 2,0 GLX (A164)	84-2/84	AKE	TP.A-053	15,5			
Sapporo 2,0 GSL (A163)	84-2/86	AKE	TP.A-053	15,5			
Shogun 2,5TD 4WD (LO42, 47)	87-91	SUM	TP.A-055	16,4			
Shogun II 2,4 (V21W, V21C)	04/91 – 10/99	AKE	TP.A-063	15,7			
Shogun II 2,5 TD 4WD (V24C, V24W)	12/90 – 10/99	AKE	TP.A-063	15,7			
Shogun II 2,8 TD (V46W)	06/94 – 10/99	AKE	TP.A-063	15,7			
Shogun II 3,0 V6 24V (4WD) (V43W, V23W)	12/90 – 10/99	AKE	TP.A-063	15,7			
Shogun II 3,5 V6 24V (V25W, V45W)	06/94 – 10/99	AKE	TP.A-063	15,7			
Shogun III 2,5 TDi (V7_W, V6_W)	04/00 – 12/06	AKE	TP.A-063	15,7			
Sigma 2,0 F11, F12, F13, 3,0 4WS	91	SUM	TP.A-055	16,4			

Марка автомобиля	Годы выпуска автомобиля	Передние колодки			Задние колодки		
		Тип тормозной системы	№ по каталогу	Толщина изделия, мм	Тип тормозной системы	№ по каталогу	Толщина изделия, мм
MITSUBISHI							
L300 2,5 Long Wheelbase	87-2/88	SUM	TP.A-055	16,4			
L300 2,5 Minibus Diesel/Minibus Turbo Diesel	87-	SUM	TP.A-055	16,4			
L300 2,5 Short Wheelbase	2/87-	SUM	TP.A-055	16,4			
L300 2,5 Van Diesel	2/87-	SUM	TP.A-055	16,4			
Montero	88-91	SUM	TP.A-055	16,4			
Pajero (L040/140/ 2600 Plane, Kombi (L047G)	84-87	SUM	TP.A-031	17,2			
Pajero (L040/140/2300 TD Plane, Kombi (L048G)	84-	SUM	TP.A-031	17,2			
Pajero (L040/140/2500 TD Plane, Kombi (L049G)	87-	SUM	TP.A-031	17,2			
Pajero 2,5 TDi (L044/49G)	87-91	SUM	TP.A-055	16,4			
Pajero 2,6 (L042G) (L047G)	87-5/91	SUM	TP.A-055	16,4			
Pajero 2,8 TDi	94-	AKE	TP.A-063	15,7			
Pajero 3,0 (L141G/L146G)	88-5/91	SUM	TP.A-055	16,4			
Pajero 3,0	91-	AKE	TP.A-063	15,7			
Pajero 3,5	93-	AKE	TP.A-063	15,7			
NEOPLAN							
Centroliner (220, 280 л.с.)	1998 –	KNORR SB 7000	TP.A-115	30,0	KNORR SB 7000	TP.A-115	30,0
Centroliner (260, 310 л.с.)	1999 – 2001	KNORR SB 7000	TP.A-115	30,0	KNORR SB 7000	TP.A-115	30,0
Centroliner (271 л.с.)	–	KNORR SB 7000	TP.A-115	30,0	KNORR SB 7000	TP.A-115	30,0
Cityliner (310, 370 л.с.)	1990 –	KNORR SB 7000	TP.A-115	30,0	KNORR SB 7000	TP.A-115	30,0
Cityliner (306, 311, 330 л.с.)	1990 – 1992	KNORR SB 7000	TP.A-115	30,0	KNORR SB 7000	TP.A-115	30,0
Cityliner (363 л.с.)	1990 – 1993	KNORR SB 7000	TP.A-115	30,0	KNORR SB 7000	TP.A-115	30,0
Cityliner (364, 381, 401, 420 л.с.)	1992 –	KNORR SB 7000	TP.A-115	30,0	KNORR SB 7000	TP.A-115	30,0
Cityliner (355 л.с.)	–	KNORR SB 7000	TP.A-115	30,0	KNORR SB 7000	TP.A-115	30,0
Cityliner (460 л.с.)	2004 –	KNORR SB 7000	TP.A-115	30,0	KNORR SB 7000	TP.A-115	30,0
Cityliner (400, 440 л.с.)	2006 –	KNORR SB 7000	TP.A-115	30,0	KNORR SB 7000	TP.A-115	30,0
Euroliner (360, 410 л.с.)	–	KNORR SB 7000	TP.A-115	30,0	KNORR SB 7000	TP.A-115	30,0
Jetliner (364 л.с.)	1992 – 1993	KNORR SB 7000	TP.A-115	30,0	KNORR SB 7000	TP.A-115	30,0
Jetliner (381, 401 л.с.)	1992 –	KNORR SB 7000	TP.A-115	30,0	KNORR SB 7000	TP.A-115	30,0
Megaliner (503 л.с.)	1993 –	KNORR SB 7000	TP.A-115	30,0	KNORR SB 7000	TP.A-115	30,0
Megashuttle (320 л.с.)	1994 –	KNORR SB 7000	TP.A-115	30,0	KNORR SB 7000	TP.A-115	30,0
Skyliner (340, 352, 355 л.с.)	1979 –	KNORR SB 7000	TP.A-115	30,0	KNORR SB 7000	TP.A-115	30,0
Skyliner (370 л.с.)	1990 –	KNORR SB 7000	TP.A-115	30,0	KNORR SB 7000	TP.A-115	30,0

Марка автомобиля	Годы выпуска автомобиля	Передние колодки			Задние колодки		
		Тип тормозной системы	№ по каталогу	Толщина изделия, мм	Тип тормозной системы	№ по каталогу	Толщина изделия, мм
NEOPLAN							
Skyliner (306, 310, 311, 330, 420 л.с.)	1990 – 1992	KNORR SB 7000	TP.A-115	30,0	KNORR SB 7000	TP.A-115	30,0
Skyliner (363, 373 л.с.)	1990 – 1993	KNORR SB 7000	TP.A-115	30,0	KNORR SB 7000	TP.A-115	30,0
Skyliner (364, 381, 401 л.с.)	1992 –	KNORR SB 7000	TP.A-115	30,0	KNORR SB 7000	TP.A-115	30,0
Skyliner (530 л.с.)	2004 –	KNORR SB 7000	TP.A-115	30,0	KNORR SB 7000	TP.A-115	30,0
Spaceliner (310 л.с.)	1990 –	KNORR SB 7000	TP.A-115	30,0	KNORR SB 7000	TP.A-115	30,0
Spaceliner (306, 330 л.с.)	1990 – 1992	KNORR SB 7000	TP.A-115	30,0	KNORR SB 7000	TP.A-115	30,0
Spaceliner (363 л.с.)	1990 – 1993	KNORR SB 7000	TP.A-115	30,0	KNORR SB 7000	TP.A-115	30,0
Spaceliner (364 л.с.)	1992 –	KNORR SB 7000	TP.A-115	30,0	KNORR SB 7000	TP.A-115	30,0
Sportliner (220 л.с.)	1990 –	KNORR SB 7000	TP.A-115	30,0	KNORR SB 7000	TP.A-115	30,0
Starliner (381, 400 л.с.)	1996 –	KNORR SB 7000	TP.A-115	30,0	KNORR SB 7000	TP.A-115	30,0
Starliner (310, 360, 409 л.с.)	2002 –	KNORR SB 7000	TP.A-115	30,0	KNORR SB 7000	TP.A-115	30,0
Tourliner (410, 460 л.с.)	2003 –	KNORR SB 7000	TP.A-115	30,0	KNORR SB 7000	TP.A-115	30,0
Tourliner (400, 440 л.с.)	2006 –	KNORR SB 7000	TP.A-115	30,0	KNORR SB 7000	TP.A-115	30,0
Transliner (192, 265, 290, 313, 340 л.с.)	1988 –	KNORR SB 7000	TP.A-115	30,0	KNORR SB 7000	TP.A-115	30,0
Transliner (364, 370, 381, 401, 420 л.с.)	1992 –	KNORR SB 7000	TP.A-115	30,0	KNORR SB 7000	TP.A-115	30,0
Transliner (306, 330, 363 л.с.)	1990 – 1992	KNORR SB 7000	TP.A-115	30,0	KNORR SB 7000	TP.A-115	30,0
Transliner (270, 320 л.с.)	1993 –	KNORR SB 7000	TP.A-115	30,0	KNORR SB 7000	TP.A-115	30,0
Transliner (252, 311 л.с.)	1990 – 1993	KNORR SB 7000	TP.A-115	30,0	KNORR SB 7000	TP.A-115	30,0
Trendliner (310, 360, 410 л.с.)	2004 –	KNORR SB 7000	TP.A-115	30,0	KNORR SB 7000	TP.A-115	30,0
NISSAN							
100 NX (B13) 1,6	03/90 – 10/94	SUM	TP.A-015	16,5			
(Z31) 300 3,0 ZX Conpe	84-87	AKE	TP.A-030	16,8			
(Z31) 300 3,0 ZX Conpe Turbo	87-90	AKE	TP.A-030	16,8			
Atlas 1,6 BF 22	88-90	AKE	TP.A-030	16,8			
Atlas 1,6 BF 22W BFG 22W	88-90	AKE	TP.A-030	16,8			
Atlas 1,6 KUF 22	90-92	AKE	TP.A-030	16,8			
Atlas 1,6 UF 22	90-92	AKE	TP.A-030	16,8			
Atlas 1,6 UF 22W, UGF 22W	90-92	AKE	TP.A-030	16,8			
Atlas 1,6 SJ 2F 23(S TYRE)	92	AKE	TP.A-030	16,8			
Atlas 1,6 SJ 2F 23(W TYRE)	92	AKE	TP.A-030	16,8			
Atlas 2,3 TF 22, TF 22W, TFG 22W	88-92	AKE	TP.A-030	16,8			
Atlas 2,3 SM 2 F23, SM 4 F23 (S, W TYRE)	92	AKE	TP.A-030	16,8			

Марка автомобиля	Годы выпуска автомобиля	Передние колодки			Задние колодки		
		Тип тормозной системы	№ по каталогу	Толщина изделия, мм	Тип тормозной системы	№ по каталогу	Толщина изделия, мм
NISSAN							
Atlas 2,7 AF 22W, AGF 22W	88-92	AKE	TP.A-030	16,8			
Atlas 2,7 SP 2 F 23, SP 4 F 23 (AT W TYRE)	92	AKE	TP.A-030	16,8			
Auster 1,8 PT 12, PT 12 TURBO	85-90	AKE	TP.A-030	16,8			
Auster 1,8 FRT 12	86-88	AKE	TP.A-030	16,8			
Avenir 1,6 VEW10 ABS	93	SUM	TP.A-060	17,0			
Avenir 1,8 W10 ABS	93	SUM	TP.A-060	17,0			
Avenir 2,0 PW10	90	SUM	TP.A-060	17,0			
Avenir 2,0 PNW10	90	SUM	TP.A-060	17,0			
Avenir 2,0 SW10	93	SUM	TP.A-060	17,0			
Avenir 2,0 VSW10 ABS	93	SUM	TP.A-060	17,0			
Bluebird (U11) All Models	84-86	AKE	TP.A-030	16,8			
Bluebird (T12) 1,8i 16V	88-89	AKE	TP.A-030	16,8			
Bluebird (T12) 2,0i SLX	86-87	AKE	TP.A-030	16,8			
Bluebird (T12) 2,0 SLX Diesel	86-90	AKE	TP.A-030	16,8			
Bluebird Traveller (WU 11) All Models	84-87	AKE	TP.A-030	16,8			
Bluebird (UK) (T72) All Models	88-91	AKE	TP.A-030	16,8			
Bluebird 1,6 U13 ABS	91	SUM	TP.A-060	17,0			
Bluebird 1,8 RNU12	87-89	SUM	TP.A-060	17,0			
Bluebird 1,8 RU12	87-89	SUM	TP.A-060	17,0			
Bluebird 1,8 EU12, TMU12 (R Disc)	89-91	SUM	TP.A-060	17,0			
Bluebird 1,8 ENU12, ENU12 (R Disc)	89-91	SUM	TP.A-060	17,0			
Bluebird 1,8 EU13 ABS	91	SUM	TP.A-060	17,0			
Bluebird EU13 super touring	92	SUM	TP.A-060	17,0			
Bluebird ENU13, ENU13 ABS	91	SUM	TP.A-060	17,0			
Bluebird HU12, HNU12, HNU12 TURBO	88-91	SUM	TP.A-060	17,0			
Bluebird HAU12	90	SUM	TP.A-060	17,0			
Bluebird HU13, HNU13, HNU13 ABS	91	SUM	TP.A-060	17,0			
Bluebird SNU13, SNU13 ABS	91	SUM	TP.A-060	17,0			
Bluebird 2,4 PU13	93	SUM	TP.A-060	17,0			
Bluebird Break (WU11) 2,0	04/86 – 09/90	AKE	TP.A-030	16,8			
Bluebird Break (WU11) 2,0 D	04/84 – 12/90	AKE	TP.A-030	16,8			
Bluebird Break (WU11) 2,0i	04/84 – 12/90	AKE	TP.A-030	16,8			
Bluebird Hatchback 1,6 (T72, T12)	03/86 – 06/91	AKE	TP.A-030	16,8			
Bluebird Hatchback 1,8i 16V (FRLT72)	02/89 – 12/90	AKE	TP.A-030	16,8			
Bluebird Hatchback 1,8 Turbo (T72, T12)	12/85 – 11/92	AKE	TP.A-030	16,8			
Bluebird Hatchback 2,0 D (FSLT72, T12)	03/86 – 12/90	AKE	TP.A-030	16,8			
Bluebird Hatchback 2,0i (FHLT72, T12)	12/85 – 12/90	AKE	TP.A-030	16,8			
Bluebird Station Wagon (WU11) 2,0	04/86 – 09/90	AKE	TP.A-030	16,8			
Bluebird Station Wagon (WU11) 2,0 D	04/84 – 12/90	AKE	TP.A-030	16,8			
Bluebird Station Wagon (WU11) 2,0i	04/84 – 12/90	AKE	TP.A-030	16,8			

Марка автомобиля	Годы выпуска автомобиля	Передние колодки			Задние колодки		
		Тип тормозной системы	№ по каталогу	Толщина изделия, мм	Тип тормозной системы	№ по каталогу	Толщина изделия, мм
NISSAN							
Caravan Bus (E24) 2,4i	05/89 – 09/93	SUM	TP.A-031	17,2			
Cedric Gloria 2,0-3,0 (non ABS)	83-93	AKE	TP.A-030	16,8			
Cefico 2,0 A31, CA31, LA31 4WAS	88-89	SUM	TP.A-060	17,0			
Cefico 2,0 A31, CA31, LA31 4WAS	89-90	SUM	TP.A-060	17,0			
Cefico 2,0 A31, CA31, LA31 4WAS	90-94	SUM	TP.A-060	17,0			
Cefico 2,0 A31, CA31, LA31	88-89	SUM	TP.A-060	17,0			
Cefico 2,0 A31, CA31, LA31	89-90	SUM	TP.A-060	17,0			
Cefico 2,0 A31, CA31, LA31	90-94	SUM	TP.A-060	17,0			
Cherry (N12) 1,0DX; 1,3GL; 1,5GL; 1,7 Diesel GL	82-86	SUM	TP.A-004	15,5			
Datsun Truck 1,6-2,7	85-92	AKE	TP.A-030	16,8			
Fairlady Z 2,0-3,0	83-89	AKE	TP.A-030	16,8			
Kubistar (X76) 1,2 -08/05	08/03-	BO	TP.A-103	18,0			
Kubistar (X76) 1,2 16V ABS(+)	04/06-	BO	TP.A-103	18,0			
Kubistar (X76) 1,5 dCi -08/05	08/03-	BO	TP.A-103	18,0			
Kubistar (X76) 1,5 dCi ABS(+)	08/03-	BO	TP.A-103	18,0			
Kubistar (X76) 1,5 dCi ABS(-)	08/03-	BO	TP.A-103	18,0			
Kubistar (X76) 1,5 dCi70 ABS(+)	04/06-	BO	TP.A-103	18,0			
Kubistar (X76) 1,5 dCi70 ABS(-)	04/06-	BO	TP.A-103	18,0			
Kubistar (X76) 1,5 dCi85 ABS(+)	04/06-	BO	TP.A-103	18,0			
Kubistar (X76) 1,5 dCi85 ABS(-)	04/06-	BO	TP.A-103	18,0			
Kubistar (X76) 1,6 16V ABS(+)	08/03-	BO	TP.A-103	18,0			
Kubistar (X76) 1,6 16V ABS(-)	08/03-	BO	TP.A-103	18,0			
Kubistar Box 1,2, ABS(+)	08/03-	BO	TP.A-103	18,0			
Kubistar Box 1,2, ABS(-)	08/03-	BO	TP.A-103	18,0			
Kubistar Box 1,2 16V, ABS(+)	04/06-	BO	TP.A-103	18,0			
Kubistar Box 1,2 16V, ABS(-)	04/06-	BO	TP.A-103	18,0			
Kubistar Box 1,5 dCi, ABS(+)	08/03-	BO	TP.A-103	18,0			
Kubistar Box 1,5 dCi, ABS(-)	08/03-	BO	TP.A-103	18,0			
Largo 2,0 VW30, VNW30 TURBO	93	SUM	TP.A-060	17,0			
Largo 2,0 VW30, VNW30	93	SUM	TP.A-060	17,0			
Laurel 2,0 HJC32, HC32, GC32	84-88	AKE	TP.A-030	16,8			
Laurel 2,0 HC 33 ABS	88-90	SUM	TP.A-060	17,0			
Laurel 2,0 HC 33	90-93	SUM	TP.A-060	17,0			
Laurel 2,0 HCC 33	88-93	SUM	TP.A-060	17,0			
Laurel 2,8 EJC 32	84-86	AKE	TP.A-030	16,8			
Laurel 2,8 SC 33 ABS	88-90	SUM	TP.A-060	17,0			
Laurel 2,8 SC 33	90-93	SUM	TP.A-060	17,0			
Laurel (jC 31/32) 2,4 ESGL; 2,8 Diesel SGLD; 2,8 Diesel SLX	85-89	SUM	TP.A-030	16,8			
Navara Pick-Up (D21) 2,4i 12V	04/92 – 02/98	AKE	TP.A-030	16,8			
Navara Pick-Up (D21) 2,4i 12V 4WD	04/92 – 02/98	AKE	TP.A-030	16,8			

Марка автомобиля	Годы выпуска автомобиля	Передние колодки			Задние колодки		
		Тип тормозной системы	№ по каталогу	Толщина изделия, мм	Тип тормозной системы	№ по каталогу	Толщина изделия, мм
NISSAN							
Primera Break (W10) 1,6i	03/94 – 03/98	SUM	TP.A-060	17,0			
Primera Break (W10) 2,0 D	07/90 – 12/95	SUM	TP.A-060	17,0			
Primera Traveller (W10) 1,6i	07/90 – 03/98	SUM	TP.A-060	17,0			
Primera Traveller (W10) 2,0 D	07/90 – 12/95	SUM	TP.A-060	17,0			
Pulsar II (N13) 1,3	07/86 – 10/91	SUM	TP.A-004	15,5			
Pulsar II (N13) 1,4 LX	10/88 – 08/91	SUM	TP.A-004	15,5			
Pulsar II (N13) 1,6i	06/86 – 10/90	SUM	TP.A-004	15,5			
Pulsar II (N13) 1,6i 12V	10/88 – 06/91	SUM	TP.A-004	15,5			
Pulsar II Sedan (N13) 1,3	07/86 – 10/91	SUM	TP.A-004	15,5			
Pulsar II Sedan (N13) 1,4 LX	10/88 – 08/91	SUM	TP.A-004	15,5			
Pulsar II Sedan (N13) 1,6i	06/86 – 10/90	SUM	TP.A-004	15,5			
Pulsar II Sedan (N13) 1,6i 12V	10/88 – 06/91	SUM	TP.A-004	15,5			
Pulsar III (N14) 1,4i	10/90 – 05/95	SUM	TP.A-015	16,5			
Pulsar III (N14) 1,6i	10/90 – 05/95	SUM	TP.A-015	16,5			
Pulsar III (N14) 1,6i 16V 4WD	10/90 – 05/95	SUM	TP.A-015	16,5			
Pulsar III (N14) 2,0 D	10/90 – 05/95	SUM	TP.A-015	16,5			
Pulsar V Sedan (N14) 1,4i	10/90 – 05/95	SUM	TP.A-015	16,5			
Pulsar V Sedan (N14) 1,6i	10/90 – 05/95	SUM	TP.A-015	16,5			
Pulsar V Sedan (N14) 1,6i 16V 4WD	10/90 – 05/95	SUM	TP.A-015	16,5			
Pulsar V Sedan (N14) 2,0 D	10/90 – 05/95	SUM	TP.A-015	16,5			
Sentra II (N13) 1,3	07/86 – 10/91	SUM	TP.A-004	15,5			
Sentra II (N13) 1,4 LX	10/88 – 08/91	SUM	TP.A-004	15,5			
Sentra II (N13) 1,6i	06/86 – 10/90	SUM	TP.A-004	15,5			
Sentra II (N13) 1,6i 12V	10/88 – 06/91	SUM	TP.A-004	15,5			
Sentra III (N14) 1,4i	10/90 – 05/95	SUM	TP.A-015	16,5			
Sentra III (N14) 1,6i	10/90 – 05/95	SUM	TP.A-015	16,5			
Sentra III (N14) 1,6i 16V 4WD	10/90 – 05/95	SUM	TP.A-015	16,5			

Марка автомобиля	Годы выпуска автомобиля	Передние колодки			Задние колодки		
		Тип тормозной системы	№ по каталогу	Толщина изделия, мм	Тип тормозной системы	№ по каталогу	Толщина изделия, мм
NISSAN							
Sentra III (N14) 2,0 D	10/90 – 05/95	SUM	TP.A-015	16,5			
Serena 2,0 KVC23, KBC23, KBCC23	91-	AKE	TP.A-030	16,8			
KBNC23, KVNC23	91-	SUM	TP.A-060	17,0			
Silvia Conpe (S12) All Models	84-89	SUM	TP.A-030	16,8			
Skyline 1,8 FJR 31	85-89	AKE	TP.A-030	16,8			
Skyline 1,8 WFJR 31	85-90	AKE	TP.A-030	16,8			
Skyline 2,0 DR 30 TURBO	83-85	AKE	TP.A-030	16,8			
Skyline 2,0 HR 31, VHR 31, + TURBO	85-89	AKE	TP.A-030	16,8			
Skyline 2,0 WHJR 31	86-90	AKE	TP.A-030	16,8			
Skyline 2,0 HR 32, YHR 32	89-93	SUM	TP.A-060	17,0			
Skyline 2,0 HR 33	93	SUM	TP.A-060	17,0			
Skyline 2,8 SP 31	85-89	AKE	TP.A-030	16,8			
Slavza (est)	89	SUM	TP.A-060	17,0			
Sunny (B11) 1,2DX; 1,5GL; 1,5 Conpe GL; 1,5 Traveller GL; 1,6 Touring, Coupe	82-88	SUM	TP.A-004	15,5			
Sunny (B12) 1,0; 1,3; 1,4; 1,6 SLX	86-91	SUM	TP.A-004	15,5			
Sunny (N13/A) 1,3 LX; 1,4 LX	86-89	SUM	TP.A-004	15,5			
Sunny (N13/A) 1,6 SLX	86-91	SUM	TP.A-004	15,5			
Sunny (N14/Y10) LX Auto	90-93	SUM	TP.A-015	16,5			
Sunny (N14/Y10) LX	93-95	SUM	TP.A-015	16,5			
Sunny (N14/Y10) SLX Auto	90-93	SUM	TP.A-015	16,5			
Sunny (N14/Y10) SLX	93-95	SUM	TP.A-015	16,5			
Sunny (N14/Y10) 2,0 Diesel LX	91-95	SUM	TP.A-015	16,5			
Sunny Conpe (B12) 1,6 SLX	89-91	SUM	TP.A-004	15,5			
Sunny(B12/A) 1,3	86-91	SUM	TP.A-004	15,5			
Sunny (B12/A) 1,6 ZWD	89-91	SUM	TP.A-004	15,5			
Sunny III (N14) 1,4i	10/90 – 05/95	SUM	TP.A-015	16,5			
Sunny III (N14) 1,6i	10/90 – 05/95	SUM	TP.A-015	16,5			
Sunny III (N14) 1,6i 16V 4WD	10/90 – 05/95	SUM	TP.A-015	16,5			
Sunny III (N14) 2,0 D	10/90 – 05/95	SUM	TP.A-015	16,5			
Sunny III Hatchback (N14) 1,4i	10/90 – 05/95	SUM	TP.A-015	16,5			
Sunny III Hatchback (N14) 1,6i	10/90 – 05/95	SUM	TP.A-015	16,5			
Sunny III Hatchback (N14) 2,0 D	10/90 – 05/95	SUM	TP.A-015	16,5			
Sunny III Liftback (N14) 1,4i	10/90 – 05/95	SUM	TP.A-015	16,5			
Sunny III Liftback (N14) 1,6i	10/90 – 05/95	SUM	TP.A-015	16,5			
Sunny III Liftback (N14) 2,0 D	10/90 – 05/95	SUM	TP.A-015	16,5			

Марка автомобиля	Годы выпуска автомобиля	Передние колодки			Задние колодки		
		Тип тормозной системы	№ по каталогу	Толщина изделия, мм	Тип тормозной системы	№ по каталогу	Толщина изделия, мм
NISSAN							
Terrano (WD21) 2,7 Turbodiesel 4WD	89-93	SUM	TP.A-031	17,2			
Terrano II (R20) 2,7 TDi	96-	SUM	TP.A-031	17,2			
Trade Box 2,0 D	11/86 – 10/98	AKE	TP.A-030	16,8			
Tsuru II (N13) 1,3	07/86 – 10/91	SUM	TP.A-004	15,5			
Tsuru II (N13) 1,4 LX	10/88 – 08/91	SUM	TP.A-004	15,5			
Tsuru II (N13) 1,6i	06/86 – 10/90	SUM	TP.A-004	15,5			
Tsuru II (N13) 1,6i 12V	10/88 – 06/91	SUM	TP.A-004	15,5			
Tsuru III (N14) 1,4i	10/90 – 05/95	SUM	TP.A-015	16,5			
Tsuru III (N14) 1,6i	10/90 – 05/95	SUM	TP.A-015	16,5			
Tsuru III (N14) 1,6i 16V 4WD	10/90 – 05/95	SUM	TP.A-015	16,5			
Tsuru III (N14) 2,0 D	10/90 – 05/95	SUM	TP.A-015	16,5			
Urvan Bus 2,4i (E24)	05/89 – 09/93	SUM	TP.A-031	17,2			
Vanette (ES)	85-95	SUM	TP.A-030	16,8			
Vanette (C120) 1,5	85-87	SUM	TP.A-030	16,8			
Vanette (C220/C22) 1,5; 1,5 VAN	87-	SUM	TP.A-030	16,8			
Vanette (C220/C22) 2,4; BNS	87-90	SUM	TP.A-030	16,8			
Vanette (C220/C22) 2,0 BUS Diesel	87-90	SUM	TP.A-030	16,8			
Vanette Cargo (C23) 1,6	91-	SUM	TP.A-030	16,8			
Vanette 1,6 KAJC 23	91	SUM	TP.A-060	17,0			
Vanette 2,0 VUJNCC 22, VUJNBC 22	88	SUM	TP.A-060	17,0			
Vanette 2,0 KMJNC 22, KUJNC 22	88-91	SUM	TP.A-060	17,0			
Vanette 2,0 RJNCC 22, FJNCC 22, UGJNC 22	88	SUM	TP.A-060	17,0			
200 SX 1,8i TURBO 16V (CE)	88-94	SUM	TP.A-060	17,0			
240 SX ABS	89-90	SUM	TP.A-060	17,0			
280 ZX 2,8 2,8D	80-82				SUM	TP.A-035	15,5
OPEL							
Admiral B 2,8E, Royal, Autom.	69-77				ATE	TP.A-001	15,0
Ascona A 1,2S	70-74	ATE	TP.A-001	15,0			
Ascona A 1,6S Voyage	-75	ATE	TP.A-001	15,0			
Ascona A 1,9S Voyage	-75	ATE	TP.A-001	15,0			
Ascona B 1,2 S, N, Berlina	78-81	GM	TP.A-002	14,5			
Ascona B 1,6 L, Berlina, Autom.	78-81	GM	TP.A-002	14,5			
Ascona B 1,6 S, L, SR, L-SR, N, Berlina	78-81	GM	TP.A-002	14,5			
Ascona B 1,9 S, L, Berlina	78-81	GM	TP.A-002	14,5			
Ascona B 2,0 D SL, Berlina	78-81	GM	TP.A-002	14,5			

Марка автомобиля	Годы выпуска автомобиля	Передние колодки			Задние колодки		
		Тип тормозной системы	№ по каталогу	Толщина изделия, мм	Тип тормозной системы	№ по каталогу	Толщина изделия, мм
OPEL							
Ascona B 2,0 E, N, S, SR, L, Berlina	78-81	GM	TP.A-002	14,5			
Ascona C 1,3 L, Berlina, Aurom.	78-81	GM	TP.A-002	14,5			
Ascona C 1,3 S	81-	GM	TP.A-002	14,5			
Ascona C 1,3 S, GLS, L, LS, N	78-81	GM	TP.A-002	14,5			
Ascona C 1,6 D, GL, GLS, LS	81-	GM	TP.A-002	14,5			
Ascona C 1,6 GL, GSR, L, LS, N, S, SR	81-82	GM	TP.A-002	14,5			
Ascona C 1,6 GSR, S, N, GT	82-88	GM	TP.A-002	14,5			
Ascona C 1,6 GT, SR	82-88	GM	TP.A-002	14,5			
Ascona C 1,6 GT, SR	84-87	GM	TP.A-002	14,5			
Ascona C 1,8i CD, GLS, S GT.SLS	81-	GM	TP.A-002	14,5			
Ascona C 1,8i SR, GL, E	81-	GM	TP.A-002	14,5			
Ascona C 1,8 LS, E	81-	GM	TP.A-002	14,5			
Ascona C 1,8 CD, GLS, E, GL, SR	81-	GM	TP.A-002	14,5			
Ascona C 2,0iE, GLS	81-	GM	TP.A-002	14,5			
Ascona C 2,0iE, LS, CD, E GT, E GL, N	81-	GM	TP.A-002	14,5			
Astra 1,4 GL, GLS	91-93	ATE	TP.A-038	16,5			
Astra 1,4i	94-	ATE	TP.A-017	18,0			
Astra 1,4i CD, GLS, GT, Club CD, GL (ABS)	91-93	ATE	TP.A-038	16,5			
Astra 1,4i GT, GT Sportive, GT Tailgate (ABS)	92-	ATE	TP.A-038	16,5			
Astra 1,4i Sportive, GT Tailgate, GLS (ABS)	91-93	ATE	TP.A-038	16,5			
Astra 1,4i Sportive, GT Tailgate, GLS (ABS)	93-	ATE	TP.A-038	16,5			
Astra 1,6i	94-	ATE	TP.A-017	18,0			
Astra 1,6i CD, GT, CD, GL. GL Sportive (ABS)	91-	ATE	TP.A-038	16,5			
Astra 1,6i GL Tailgate, GT Tailgate (ABS)	91-	ATE	TP.A-038	16,5			
Astra 1,6i GT (ABS)	92-	ATE	TP.A-038	16,5			
Astra 1,7 D Club, GL, GLS, Tailgate (ABS)	93-	ATE	TP.A-038	16,5			
Astra 1,7 D TD All Models (ABS)	91-	ATE	TP.A-038	16,5			
Astra 1,8i 16V	94-	ATE	TP.A-017	18,0			
Astra 1,8i 16V GL Sportive, GL Young (ABS)	93-	ATE	TP.A-017	18,0			
Astra 1,8i 16V Gsi, CD, GLS (ABS)	91-	ATE	TP.A-017	18,0			
Astra 1,8i All Models	91-	ATE	TP.A-038	16,5			
Astra 1,8i CD, GL Sportive, GL Tailgate (ABS)	93-	ATE	TP.A-038	16,5			
Astra 1,8i GL, GLS, GT (ABS)	91-	ATE	TP.A-038	16,5			
Astra 2,0i 16V	94-	ATE	TP.A-017	18,0			
Astra 2,0i 16V Gsi, CD (ABS)	91-	ATE	TP.A-017	18,0			
Astra 2,0i All Models (ABS)	91-	ATE	TP.A-017	18,0			
Astra 2,0i Club Young, GLS Sportive, GLS(ABS)	93-	ATE	TP.A-017	18,0			
Astra Cabrio 1,8i	94-	ATE	TP.A-017	18,0			
Astra Cabrio 2,0i	94-	ATE	TP.A-017	18,0			
Astra Caravan 1,4 GLS	91-	ATE	TP.A-038	16,5			
Astra Caravan 1,6i	94-	ATE	TP.A-017	18,0			
Astra Caravan 1,6i CD, GL Sportive, Young, GLS	91-	ATE	TP.A-038	16,5			
Astra Caravan 1,8i 16V	94-	ATE	TP.A-017	18,0			

Марка автомобиля	Годы выпуска автомобиля	Передние колодки			Задние колодки		
		Тип тормозной системы	№ по каталогу	Толщина изделия, мм	Тип тормозной системы	№ по каталогу	Толщина изделия, мм
OPEL							
Astra Caravan 2,0i	94-	ATE	TP.A-017	18,0			
Astra Caravan 2,0i 16V	94-	ATE	TP.A-017	18,0			
Astra Caravan 1,7 D	91-	GM	TP.A-002	14,5			
Astra Caravan 1,7 D	91-	ATE	TP.A-038	16,5			
Astra F Box (55_) 1,4i	10/91 – 01/99	ATE	TP.A-038	16,5			
Astra F Box (55_) 1,6i	10/91 – 07/96	ATE	TP.A-038	16,5			
Astra F Box (55_) 1,7 D / TD	12/91 – 01/99	ATE	TP.A-017	18,0			
Astra F Classic Estate 1,4i	01/98 – 01/05	ATE	TP.A-038	16,5			
Astra F Classic Estate 1,6i	01/98 – 01/05	ATE	TP.A-038	16,5			
Astra F Classic Sedan 1,4i	01/98 – 08/02	ATE	TP.A-038	16,5			
Astra F Classic Sedan 1,6i	01/98 – 08/02	ATE	TP.A-038	16,5			
Astra F Convertible (53_B) 1,4i 16V	01/96 – 03/01	ATE	TP.A-017	18,0			
Astra F Convertible (53_B) 1,4 Si	05/93 – 03/01	ATE	TP.A-038	16,5			
Astra F Convertible (53_B) 1,6i	03/93 – 03/01	ATE	TP.A-017 TP.A-038	18,0 16,5			
Astra F Convertible (53_B) 1,8i 16V	11/94 – 03/01	ATE	TP.A-017	18,0			
Astra F Convertible (53_B) 2,0i	03/93 – 10/94	ATE	TP.A-017	18,0			
Astra F Estate (51_, 52_) 1,4	09/91 – 01/98	ATE	TP.A-017 TP.A-038	18,0 16,5			
Astra F Estate (51_, 52_) 1,4i / Si	09/91 – 01/98	ATE	TP.A-017 TP.A-038	18,0 16,5			
Astra F Estate (51_, 52_) 1,6	09/95 – 01/98	ATE	TP.A-017 TP.A-038	18,0 16,5			
Astra F Estate (51_, 52_) 1,6i	09/91 – 01/98	ATE	TP.A-017 TP.A-038	18,0 16,5			
Astra F Estate (51_, 52_) 1,6i 16V / Si	03/92 – 01/98	ATE	TP.A-017	18,0			
Astra F Estate (51_, 52_) 1,7 D / TD / TDS	12/91 – 01/98	ATE	TP.A-017 TP.A-038	18,0 16,5			
Astra F Estate (51_, 52_) 1,8i	09/91 – 01/98	ATE	TP.A-038	16,5			
Astra F Estate (51_, 52_) 1,8i 16V	06/93 – 01/98	ATE	TP.A-017	18,0			
Astra F Estate (51_, 52_) 2,0i	09/91 – 07/94	ATE	TP.A-017	18,0			
Astra F Estate (51_, 52_) 2,0i 16 V	03/93 – 01/98	ATE	TP.A-017	18,0			
Calibra 2,0i 4x4 (ABS)	94-	ATE	TP.A-017	18,0			
Calibra 2,0i 16V 4x4 (ABS)	89-	ATE	TP.A-017	18,0			
Calibra 2,0i All Models (ABS)	89-	ATE	TP.A-017	18,0			
Calibra 2,0i 4x4 (ABS)	89-	ATE	TP.A-017	18,0			

Марка автомобиля	Годы выпуска автомобиля	Передние колодки			Задние колодки		
		Тип тормозной системы	№ по каталогу	Толщина изделия, мм	Тип тормозной системы	№ по каталогу	Толщина изделия, мм
OPEL							
Calibra 2,0i Turbo 16V	2/92-94	ATE	TP.A-066	18,0 17,0			
Calibra 2,5i V6 all models	9/93-94	ATE	TP.A-066	18,0 17,0			
Combo 1,3; 1,4 ind. autom.	87-	GM	TP.A-002	15,6			
Combo Box Body/Estate 1,3 CDTI 16V	08/05-	TRW	TP.A-101	16,8			
Combo Box Body/Estate 1,4 16V	08/05-	TRW	TP.A-101	16,8			
Combo Box Body/Estate 1,6	10/01-	TRW	TP.A-101	16,8			
Combo Box Body/Estate 1,6 16V	06/06-	TRW	TP.A-101	16,8			
Combo Box Body/Estate 1,7 DI 16V	10/01-	TRW	TP.A-101	16,8			
Combo Box Body/Estate 1,7 DTI 16V	10/01-	TRW	TP.A-101	16,8			
Combo MPV 1,3 CDTI	10/04-	TRW	TP.A-101	16,8			
Combo MPV 1,4	10/04-	TRW	TP.A-101	16,8			
Combo MPV 1,6	08/01-	TRW	TP.A-101	16,8			
Combo MPV 1,6 16V	06/06-	TRW	TP.A-101	16,8			
Combo MPV 1,7 CDTI 16V	12/04-	TRW	TP.A-101	16,8			
Combo MPV 1,7 DI 16V	10/01-	TRW	TP.A-101	16,8			
Combo MPV 1,7 DTI 16V	10/01-	TRW	TP.A-101	16,8			
Combo (71_) 1,2	07/94 – 10/01	ATE	TP.A-038	16,5			
Combo (71_) 1,4	07/94 – 10/01	ATE	TP.A-038	16,5			
Combo (71_) 1,7 D	07/94 – 10/01	ATE	TP.A-038	16,5			
Corsa A 1,0 S, TR	83-91	GM	TP.A-002	14,5			
Corsa A 1,2i City, Eco, GLS (ABS)	93-	ATE	TP.A-038	16,5			
Corsa A 1,2i GL, Joy, Sport, Swing	90-92	GM	TP.A-002	14,5			
Corsa A 1.2i Joy, Sport, Swing	91-93	ATE	TP.A-038	16,5			
Corsa A 1.2i Joy, Sport, Swing (ABS)	93-	ATE	TP.A-038	16,5			
Corsa A 1,2 S GL, GLS, LS, N, GL, S GL	84-	GM	TP.A-002	14,5			
Corsa A 1,2 S TR, All Models	82-	GM	TP.A-002	14,5			
Corsa A 1,3 GL, GLS, LS, GT, S GL	82-	GM	TP.A-002	14,5			
Corsa A 1,3 S GL, GLS, LS	85-88	GM	TP.A-002	14,5			
Corsa A 1,3 S TR, GL, GLS, LS	85-88	GM	TP.A-002	14,5			
Corsa A 1,4i GT, Joy, Sport, Swing	90-91	GM	TP.A-002	14,5			
Corsa A 1,4i Si (ABS)	93-	ATE	TP.A-038	16,5			
Corsa A 1,6i Si	83-91	GM	TP.A-002	14,5			
Corsa A 1,6i Gsi 16V	93-	ATE	TP.A-038	16,5			
Corsa A 1,5D City, Eco, Joy, Swing	92-	ATE	TP.A-038	16,5			
Corsa A 1,5D City, Sport, Swing	87-90	GM	TP.A-002	14,5			
Corsa A 1,5D TD Sport, Swing	87-91	GM	TP.A-002	14,5			
Corsa A 1,5D TD Sport, Swing	91-93	ATE	TP.A-038	16,5			
Corsa A 1,2 S	91-93	GM	TP.A-002	14,5			
Corsa A 1,2 S	91-93	ATE	TP.A-038	16,5			
Corsa A 1,5 D	83-91	GM	TP.A-002	14,5			

Марка автомобиля	Годы выпуска автомобиля	Передние колодки			Задние колодки		
		Тип тормозной системы	№ по каталогу	Толщина изделия, мм	Тип тормозной системы	№ по каталогу	Толщина изделия, мм
OPEL							
Corsa A 1,5 D	91-	ATE	TP.A-038	16,5			
Corsa B (73_, 78_, 79_) 1,0i 12V	11/96 – 09/00	ATE	TP.A-038	16,5			
Corsa B (73_, 78_, 79_) 1,2i	03/93 – 09/00	ATE	TP.A-038	16,5			
Corsa B (73_, 78_, 79_) 1,2i 16V	03/98 – 09/00	ATE	TP.A-038	16,5			
Corsa B (73_, 78_, 79_) 1,4i	03/93 – 09/00	ATE	TP.A-038	16,5			
Corsa B (73_, 78_, 79_) 1,4i 16V	09/94 – 09/00	ATE	TP.A-038	16,5			
Corsa B (73_, 78_, 79_) 1,4 Si	03/93 – 09/00	ATE	TP.A-038	16,5			
Corsa B (73_, 78_, 79_) 1,5 D / TD	03/93 – 09/00	ATE	TP.A-038	16,5			
Corsa B (73_, 78_, 79_) 1,6 GSI 16V	03/93 – 09/00	ATE	TP.A-038	16,5			
Corsa B (73_, 78_, 79_) 1,6i 16V	09/94 – 09/00	ATE	TP.A-038	16,5			
Corsa B (73_, 78_, 79_) 1,7 D	02/96 – 09/00	ATE	TP.A-038	16,5			
Corsa B Box (73_) 1,6	08/05-	TRW	TP.A-101	16,8			
Corsa B Box (73_) 1,7 DTi, -07/03	08/01-	TRW	TP.A-101	16,8			
Corsa B Box (73_) 1,4i	08/99 – 09/00	ATE	TP.A-038	16,5			
Corsa B Box (73_) 1,7 D	08/99 – 09/00	ATE	TP.A-038	16,5			
Corsa C (F08, F68) 1,0, ABS(+)	09/00-	TRW	TP.A-101	16,8			
Corsa C (F08, F68) 1,0, ABS(-)	09/00-	TRW	TP.A-101	16,8			
Corsa C (F08, F68) 1,2, ABS(+)	09/00-	TRW	TP.A-101	16,8			
Corsa C (F08, F68) 1,2, ABS(-)	09/00-	TRW	TP.A-101	16,8			
Corsa C (F08,F68) 1,2 Twinport, ABS(+)	07/04-	TRW	TP.A-101	16,8			
Corsa C (F08,F68) 1,2 Twinport, ABS(-)	07/04-	TRW	TP.A-101	16,8			
Corsa C (F08,F68) 1,3 CDTI	06/03-	TRW	TP.A-101	16,8			
Corsa C (F08,F68) 1,4	09/00-	TRW	TP.A-101	16,8			
Corsa C (F08,F68) 1,4 Twinport, ABS(+)	06/03-	TRW	TP.A-101	16,8			
Corsa C (F08,F68) 1,7 DI	09/00-	TRW	TP.A-101	16,8			
Corsa C (F08,F68) 1,7 DTI	09/00-	TRW	TP.A-101	16,8			
Corsa C (F08,F68) 1,8 16"	09/00-	TRW	TP.A-101	16,8			
Corsa C Box (F08, W5L) 1,2, ABS(+)	07/05-	TRW	TP.A-101	16,8			
Corsa C Box (F08, W5L) 1,2, ABS(-)	07/05-	TRW	TP.A-101	16,8			
Corsa C Box (F08, W5L) 1,2 16V,-07/03	09/00-	TRW	TP.A-101	16,8			
Corsa C Box (F08, W5L) 1,2 16V, -07/03, ABS(+)	09/00-	TRW	TP.A-101	16,8			
Corsa C Box (F08, W5L) 1,3 CDTI 16V	08/05-	TRW	TP.A-101	16,8			
Corsa C Box (F08, W5L) 1,4	08/03-	TRW	TP.A-101	16,8			

Марка автомобиля	Годы выпуска автомобиля	Передние колодки			Задние колодки		
		Тип тормозной системы	№ по каталогу	Толщина изделия, мм	Тип тормозной системы	№ по каталогу	Толщина изделия, мм
OPEL							
Corsa C Box (F08, W5L) 1,6	08/05-	TRW	TP.A-101	16,8			
Corsa C Box (F08, W5L) 1,7 DI 16V, -07/03, ABS(+)	09/00-	TRW	TP.A-101	16,8			
Corsa C Box (F08, W5L) 1,7 DTI 16V, -07/03, ABS(+)	09/00-	TRW	TP.A-101	16,8			
Diplomat B 2,8 E	69-77				ATE	TP.A-001	15,0
Diplomat B 2,8 S	69-77				ATE	TP.A-001	15,0
Diplomat B 5,4 S, Autom.	69-77				ATE	TP.A-001	15,0
Kadett 1,3 CS, GLS, GL, L, LS, N, GL (ABS)	84-91	GM	TP.A-002	14,5			
Kadett 1,3 E, LS (ABS)	89-90	GM	TP.A-002	14,5			
Kadett 1,3 L, LS, S (ABS)	87-89	GM	TP.A-002	14,5			
Kadett 1,3 LS, S GL, S GT, SL, NS, NGLS(ABS)	84-89	GM	TP.A-002	14,5			
Kadett C 1,7 D All Models	67-73	ATE	TP.A-001	15,0			
Kadett C 1,9 All Models	67-73	ATE	TP.A-001	15,0			
Kadett C 1,0 L, LS, S	73-79	ATE	TP.A-001	15,0			
Kadett C 1,2 L, LS, S, SR, City, Special	73-79	ATE	TP.A-001	15,0			
Kadett D 1,0 L, S, S City	79-84	GM	TP.A-002	14,5			
Kadett D 1,2 S, L, City, S.C, LS, Special	79-84	GM	TP.A-002	14,5			
Kadett D 1,2 S.C. Special, ST Special	79-84	GM	TP.A-002	14,5			
Kadett D 1,3 L, N, NL, S, SRL	79-84	GM	TP.A-002	14,5			
Kadett D 1,6 L, LS, SR	79-84	GM	TP.A-002	14,5			
Kadett D 1,6 S Voyage, City	79-84	GM	TP.A-002	14,5			
Kadett D 1,8i GTE	79-84	GM	TP.A-002	14,5			
Kadett D 1,6 D All Models	79-84	GM	TP.A-002	14,5			
Kadett D Caravan 1,2 L, S, GL, LS	79-84	GM	TP.A-002	14,5			
Kadett D Caravan 1,2 L, S, GL, LS (ABS)	85-89	GM	TP.A-002	14,5			
Kadett D Caravan 1,3 L, S, GL, GLS	79-84	GM	TP.A-002	14,5			
Kadett D Caravan 1,3 NL, NS, NSR (ABS)	85-92	GM	TP.A-002	14,5			
Kadett D Caravan 1,6 L, LS, GL, GLS, Voyage	79-84	GM	TP.A-002	14,5			
Kadett D Caravan 1,6 L, LS, GL, GLS, Voyage (ABS)	85-92	GM	TP.A-002	14,5			
Kadett D Caravan 1,6 DL, GL, GLS	79-84	GM	TP.A-002	14,5			
Kadett D Caravan 1,6 DL, GL, GLS (ABS)	85-92	GM	TP.A-002	14,5			
Kadett E 1,2 CS, GLS, GL, S.C, L, LS (ABS)	84-91	GM	TP.A-002	14,5			
Kadett E 1,2 L, S, NL, LS (ABS)	84-91	GM	TP.A-002	14,5			
Kadett E 1,4i CD, L, LS, S, GL, GLS (ABS)	91-92	GM	TP.A-002	14,5			
Kadett E 1,4i L, LS (ABS)	89-90	GM	TP.A-002	14,5			
Kadett E 1,6i S CD, GL, GLS, L, LS	90-92	GM	TP.A-002	14,5			
Kadett E 1,6i S GL, GT (ABS)	84-87	GM	TP.A-002	14,5			
Kadett E 1,6i S GT, Si (ABS)	89-92	GM	TP.A-002	14,5			
Kadett E 1,6 S GL, GLS, LS, GT, EL, ES	84-87	GM	TP.A-002	14,5			
Kadett E 1,6 S GL, GLS, LS, GT, EL, ES (ABS)	84-87	GM	TP.A-002	14,5			
Kadett E 1,8 Frisco GL, GLS, L, LS	88-91	GM	TP.A-002	14,5			
Kadett E 1,8 Frisco GL, GLS, L, LS (ABS)	88-91	ATE	TP.A-017	18,0			
Kadett E 1,8 GT, GL, GLS, L, LS, S GT	87-89	GM	TP.A-002	14,5			
Kadett E 1,8 GT, GL, GLS, L, LS, SGT (ABS)	87-89	ATE	TP.A-017	18,0			

Марка автомобиля	Годы выпуска автомобиля	Передние колодки			Задние колодки		
		Тип тормозной системы	№ по каталогу	Толщина изделия, мм	Тип тормозной системы	№ по каталогу	Толщина изделия, мм
OPEL							
Kadett E 1,8i CS, GL, GLS, Frisco, L, LS	84-91	GM	TP.A-002	14,5			
Kadett E 1,8i CS, GL, GLS, Frisco, L, LS (ABS)	84-91	GM	TP.A-002	14,5			
Kadett E 1,8i CS, GL, GLS, Frisco, L, LS	89-92	ATE	TP.A-017	18,0			
Kadett E 1,8i CS, GL, GLS, Frisco, L, LS (ABS)	89-92	ATE	TP.A-017	18,0			
Kadett E 1,8i GL, GLS, SLS, S, GT (ABS)	89-92	ATE	TP.A-017	18,0			
Kadett E 1,8i GL, GLS, SLS, S GT, GTi	89-92	ATE	TP.A-017	18,0			
Kadett E 1,8i GTi, Gsi All Models	89-92	GM	TP.A-002	14,5			
Kadett E 1,8i L, LS, S (ABS)	87-89	ATE	TP.A-017	18,0			
Kadett E 2,0i 16V GSi	84-88	GM	TP.A-002	14,5			
Kadett E 2,0i 16V Gsi (ABS)	88-	ATE	TP.A-017	18,0			
Kadett E 2,0i Gsi All Models (ABS)	84-91	GM	TP.A-002	14,5			
Kadett E 2,0i Gsi All Models (ABS)	86-92	ATE	TP.A-017	18,0			
Kadett E 1,5 D Turbo	85-91	GM	TP.A-002	14,5			
Kadett E 1,5 D Turbo (ABS)	85-91	GM	TP.A-002	14,5			
Kadett E 1,6 D SC, GL, GLS, L, LS, S (ABS)	85-91	GM	TP.A-002	14,5			
Kadett E 1,6 D GL, LS	84-88	GM	TP.A-002	14,5			
Kadett E 1,6 D GL, LS (ABS)	86-87	GM	TP.A-002	14,5			
Kadett E 1,6 D L, LS (ABS)	87-89	GM	TP.A-002	14,5			
Kadett E 1,7 D GL, GLS, L, LS (ABS)	89-92	GM	TP.A-002	14,5			
Kadett E 1,7 D GL, GLS, LS	89-92	GM	TP.A-002	14,5			
Kadett E 1,7 D GL, GLS, LS (ABS)	91-92	GM	TP.A-002	14,5			
Kadett E Box (37_, 47_) 1,4i	01/90 – 08/91	GM	TP.A-002	14,5			
Kadett E Box (37_, 47_) 1,6i / D	08/84 – 09/93	GM	TP.A-002	14,5			
Kadett E Box (37_, 47_) 1,7 D	08/88 – 09/92	GM	TP.A-002	14,5			
Kadett E Box (37_, 47_) 1,8i	08/84 – 09/92	GM	TP.A-002	14,5			
Kadett E Cabrio (43B_) 1,3 S	03/87 – 02/93	GM	TP.A-002	14,5			
Kadett E Cabrio (43B_) 1,4i / S	01/90 – 02/93	GM	TP.A-002	14,5			
Kadett E Cabrio (43B_) 1,6i	10/86 – 02/93	GM	TP.A-002	14,5			
Kadett E Cabrio (43B_) 1,6i KAT	10/87 – 02/93	GM	TP.A-002	14,5			
Kadett E Cabrio (43B_) 2,0i	10/86 – 02/93	GM	TP.A-002	14,5			
Kadett E Cabrio (43B_) 2,0i KAT	10/86 – 02/93	GM	TP.A-002	14,5			
Kadett E Caravan 1,2 L, S, GL, LS	79-92	GM	TP.A-002	14,5			
Kadett E Caravan 1,2 L, S, GL, LS (ABS)	85-92	GM	TP.A-002	14,5			
Kadett E Caravan 1,3 L, S, GL, GLS	79-84	GM	TP.A-002	14,5			
Kadett E Caravan 1,3 NL, NS, NSR (ABS)	85-92	GM	TP.A-002	14,5			
Kadett E Caravan 1,4i CD,L,LS,GL,GLS(ABS)	89-92	GM	TP.A-002	14,5			
Kadett E Caravan 1,6 L,LS,GL,GLS,Voyage	79-84	GM	TP.A-002	14,5			

Марка автомобиля	Годы выпуска автомобиля	Передние колодки			Задние колодки		
		Тип тормозной системы	№ по каталогу	Толщина изделия, мм	Тип тормозной системы	№ по каталогу	Толщина изделия, мм
OPEL							
Kadett E Caravan 1,6 L,LS,GL,GLS, Voyage (ABS)	85-92	GM	TP.A-002	14,5			
Kadett E Caravan 1,8i CD,L,LS,S,GL, GLS (ABS)	84-89	GM	TP.A-002	14,5			
Kadett E Caravan 1,8i CD,L,LS,S,GL, GLS (ABS)	90-	ATE	TP.A-017	18,0			
Kadett E Caravan 1,6 D L, GL, GLS	79-84	GM	TP.A-002	14,5			
Kadett E Caravan 1,6 D L, GL, GLS (ABS)	85-92	GM	TP.A-002	14,5			
Kadett E Caravan 1,3 L, S, GL, GLS	79-84	GM	TP.A-002	14,5			
Kadett E Caravan 1,3 L, S, GL, GLS Voyage	85-92	GM	TP.A-002	14,5			
Kadett E Caravan 1,7 D L, LS, S (ABS)	89-92	GM	TP.A-002	14,5			
Manta A 1,2 S	70-74	ATE	TP.A-001	15,0			
Manta A 1,6	70-74	ATE	TP.A-001	15,0			
Manta A 1,9 S	70-74	ATE	TP.A-001	15,0			
Manta B 1,2 S, N	78-83	GM	TP.A-002	14,5			
Manta B 1,3 S, N	78-84	GM	TP.A-002	14,5			
Manta B 1,6 S, N	76-81	GM	TP.A-002	14,5			
Manta B 1,8 S	78-88	GM	TP.A-002	14,5			
Manta B 1,9i E, S, G TE	78-88	GM	TP.A-002	14,5			
Manta B 2,0i Gsi, N GT, E, GT, GTE	85-88	GM	TP.A-002	14,5			
Manta B 2,0i 400 All Models	84-88	GM	TP.A-002	14,5			
Manta E 2,0 All Models	78-82	GM	TP.A-002	14,5			
Manta E 2,0i 200 Gsi, N GT	85-88	GM	TP.A-002	14,5			
Meriva 1,4 16V Twinport, 14"	07/04-	TRW	TP.A-101	16,8			
Meriva 1,6, Ø260,0 mm	05/03-	TRW	TP.A-101	16,8			
Meriva 1,6, Ø280,0 mm	05/03-	TRW	TP.A-101	16,8			
Monza A 2,0i C, E	-83				ATE	TP.A-001	15,0
Monza A 2,0i E All Models	83-86				ATE	TP.A-001	15,0
Monza A 2,3 D	78-83				ATE	TP.A-001	15,0
Monza A 2,3 D	83-86				ATE	TP.A-001	15,0
Monza A 2,5i C, E	78-83				ATE	TP.A-001	15,0
Monza A 2,5i E All Models	83-86				ATE	TP.A-001	15,0
Monza A 2,8 C, H	81-83				ATE	TP.A-001	15,0
Monza A 2,8 C, H	83-87				ATE	TP.A-001	15,0
Monza A 3,0 C, E, H, S, GSE, Sport	78-83				ATE	TP.A-001	15,0
Monza A 3,0i C, GSEH, S	80-86				ATE	TP.A-001	15,0
Monza A 3,0i E Sport, CD, GSE	84-87				ATE	TP.A-001	15,0
Monza E (39_, 49_) 1,3i KAT	09/85 – 08/91	GM	TP.A-002	14,5			
Monza E (39_, 49_) 1,4i / S	01/90 – 08/91	GM	TP.A-002	14,5			
Monza E (39_, 49_) 1,5 TD	07/88 – 08/91	GM	TP.A-002	14,5			
Monza E (39_, 49_) 1,6i KAT	09/86 – 08/91	GM	TP.A-002	14,5			
Monza E (39_, 49_) 1,6 S / D	09/84 – 08/91	GM	TP.A-002	14,5			

Марка автомобиля	Годы выпуска автомобиля	Передние колодки			Задние колодки		
		Тип тормозной системы	№ по каталогу	Толщина изделия, мм	Тип тормозной системы	№ по каталогу	Толщина изделия, мм
OPEL							
Monza E (39_, 49_) 1,7 D	02/89 – 08/91	GM	TP.A-002	14,5			
Monza E (39_, 49_) 1,8i / S	09/84 – 08/91	GM ATE	TP.A-002 TP.A-017	14,5 18,0			
Monza E (39_, 49_) 2,0i (KAT)	03/87 – 08/91	GM ATE	TP.A-002 TP.A-017	14,5 18,0			
Omega 2,0i CD/GL/Comfort	6/94-	ATE	TP.A-066	17,0/18,0	ATE	TP.A-010	15,5
Omega 2,6i CD/GL/GLS (ABS)	9/91-	ATE	TP.A-066	17,0/18,0	ATE	TP.A-010	15,5
Omega A 1,8i All Models (ABS)	86-88	GM	TP.A-002	14,5			
Omega A 1,8i GL, GLS, N, GL, N LS, S LS (ABS)	88-	GM	TP.A-002	14,5	ATE	TP.A-010	15,5
Omega A 1,8i GL, GLS, N, GL, N LS, S LS (ABS)	86-88	GM	TP.A-002	14,5			
Omega A 2,0i CD, GL, GLS (ABS)	86-88	GM	TP.A-002	14,5			
Omega A 2,0i SD, GL, GLS (ABS)	92-93	ATE	TP.A-017	18,0	ATE	TP.A-010	15,5
Omega A 2,0i GL, SE, LS, GLS (ABS)	86-89	GM	TP.A-002	14,5			
Omega A 2,0i GL, SE, LS, GLS (ABS)	92-93	ATE	TP.A-017	18,0	ATE	TP.A-010	15,5
Omega A 2,4i CD, GL, GLS, LS (ABS)	86-88	GM	TP.A-002	14,5			
Omega A 2,4i GL, SE, LS, GLS (ABS)	88-	ATE	TP.A-017	18,0	ATE	TP.A-010	15,5
Omega A 2,3 D GL, GLS, LS, Turbo GL (ABS)	86-88	GM	TP.A-002	14,5			
Omega A 2,3 D GL, GLS, LS, Turbo GL, T, LS (ABS)	89-	ATE	TP.A-017	18,0	ATE	TP.A-010	15,5
Omega A 2,3 D LS, Turbo LS (ABS)	86-88	GM	TP.A-002	14,5			
Omega A (16_, 17_, 19_) 3,0 (3000)	03/87 – 09/90				ATE	TP.A-010	15,5
Omega A (16_, 17_, 19_) 3,0 (3000) KAT	03/88 – 03/94				ATE	TP.A-010	15,5
Omega A (16_, 17_, 19_) 3,0 24V (3000)	09/89 – 03/94				ATE	TP.A-010	15,5
Omega A (16_, 17_, 19_) 3,0 24V Evolution 500	03/91 – 07/92				ATE	TP.A-010	15,5
Omega A Caravan 1,8i S LS (ABS)	88-	GM	TP.A-002	14,5	ATE	TP.A-010	15,5
Omega A Caravan 2,0i CD, GL, GLS (ABS)	86-88	GM	TP.A-002	14,5	ATE	TP.A-010	15,5
Omega A Caravan 2,3 D GL, GLS, LS, Turbo GL	86-89	GM	TP.A-002	14,5	ATE	TP.A-010	15,5
Omega A Caravan 2,3 D GL, GLS, LS, Turbo GL, TL	89-	ATE	TP.A-017	18,0	ATE	TP.A-010	15,5
Omega A Caravan 2,3 DLS, Turbo LS (ABS)	86-89	GM	TP.A-002	14,5	ATE	TP.A-010	15,5
Omega A Caravan 2,4i GL, GLS, LS (ABS)	86-88	GM	TP.A-002	14,5	ATE	TP.A-010	15,5
Omega A Caravan 2,3 D GL, GLS, LS, Turbo GL (ABS)	86-89	GM	TP.A-002	14,5	ATE	TP.A-010	15,5
Omega A Caravan 2,3 D GL, GLS, LS, Tur GL, Tur T	89-	ATE	TP.A-017	18,0	ATE	TP.A-010	15,5
Omega A Estate (66_, 67_) 1,8 (N, S)	09/86 – 03/94	GM	TP.A-002	14,5	ATE	TP.A-010	15,5
Omega A Estate (66_, 67_) 2,0	09/86 – 03/94	GM ATE	TP.A-002 TP.A-017	14,5 18,0	ATE	TP.A-010	15,5
Omega A Estate (66_, 67_) 2,0i	09/86 – 03/94	GM ATE	TP.A-002 TP.A-017	14,5 18,0	ATE	TP.A-010	15,5
Omega A Estate (66_, 67_) 2,3 D / TD	09/86 – 03/94	GM ATE	TP.A-002 TP.A-017	14,5 18,0	ATE	TP.A-010	15,5
Omega A Estate (66_, 67_) 2,3 TD Interc.	09/88 – 03/94	GM ATE	TP.A-002 TP.A-017	14,5 18,0	ATE	TP.A-010	15,5

Марка автомобиля	Годы выпуска автомобиля	Передние колодки			Задние колодки		
		Тип тормозной системы	№ по каталогу	Толщина изделия, мм	Тип тормозной системы	№ по каталогу	Толщина изделия, мм
OPEL							
Senator A 2,3 D All Models	83-86				ATE	TP.A-001	15,0
Senator A 2,3 D TD	-83				ATE	TP.A-001	15,0
Senator B (29_) 2,5i	09/90 – 09/93				ATE	TP.A-010	15,5
Senator B (29_) 2,6i	09/90 – 09/93				ATE	TP.A-010	15,5
Senator B (29_) 3,0	09/87 – 09/93				ATE	TP.A-010	15,5
Senator B (29_) 3,0 24V	09/89 – 09/93				ATE	TP.A-010	15,5
Senator B (29_) 3,0i KAT	01/88 – 09/93				ATE	TP.A-010	15,5
Tigra 1,4i 16V All Models	94-	ATE	TP.A-038	16,5			
Tigra 1,6i 16V All Models	94-	ATE	TP.A-038	16,5			
Tigra Convertible 1,3 CDTI, 11/04-	06/04-	TRW	TP.A-101	16,8			
Tigra Convertible 1,4	06/04-	TRW	TP.A-101	16,8			
Tigra Convertible 1,8	06/04-	TRW	TP.A-101	16,8			
Tigra TwinTop 1,3 CDTI	06/04 –	TRW	TP.A-101	16,8			
Tigra TwinTop 1,4	06/04 –	TRW	TP.A-101	16,8			
Tigra TwinTop 1,8	06/04 –	TRW	TP.A-101	16,8			
Vectra 2,0i 4WD 16V	9/92-94	ATE	TP.A-066	17,0/18,0			
Vectra 2,0 Turbo Diesel injection 16V	4/96-	ATE	TP.A-066	17,0/18,0			
Vectra 2,5i V6	92-10/95	ATE	TP.A-066	17,0/18,0			
Vectra A 1,4 Diamond, GL	88-91	GM	TP.A-002	14,5			
Vectra A 1,4 Diamond, GL (ABS)	91-	ATE	TP.A-038	16,5			
Vectra A 1,6 GL, GLS	88-91	GM	TP.A-002	14,5			
Vectra A 1,6 GL, GLS (ABS)	91-	GM	TP.A-002	15,6			
Vectra A 1,6 GL, GLS (ABS)	91-	ATE	TP.A-038	16,5			
Vectra A 1,6i S GL, GLS	88-91	GM	TP.A-002	14,5			
Vectra A 1,6i S GL, GLS (ABS)	88-91	GM	TP.A-002	14,5			
Vectra A 1,6i S GL, GLS (ABS)	92-	ATE	TP.A-038	16,5			
Vectra A 1,7 D CD/GL/GLS	91-	ATE	TP.A-038	16,5			
Vectra A 1,7 D CD/GL/GLS (ABS)	92-	ATE	TP.A-038	16,5			
Vectra A 1,7 D GL/GLS	88-91	GM	TP.A-002	14,5			
Vectra A 1,7i D/TD/CD/GLS/GLi (ABS)	92-	ATE	TP.A-038	16,5			
Vectra A 1,8i GT 4x4	88-90	ATE	TP.A-017	18,0			
Vectra A 1,8i GT 4x4 (ABS)	88-90	ATE	TP.A-017	18,0			
Vectra A 1,8i GT 4x4	88-91	GM	TP.A-002	14,5			
Vectra A 1,8i GT 4x4 (ABS)	88-91	GM	TP.A-002	14,5			
Vectra A 1,8i GT 4x4	92-	ATE	TP.A-038	16,5			
Vectra A 1,8i GT 4x4 (ABS)	92-	ATE	TP.A-038	16,5			
Vectra A 1,8i S GL, CD, GT	92-	ATE	TP.A-038	16,5			
Vectra A 1,8i S GL, GT	88-90	GM	TP.A-002	14,5			
Vectra A 1,8i S GL, GT (ABS)	88-91	GM	TP.A-002	14,5			

Марка автомобиля	Годы выпуска автомобиля	Передние колодки			Задние колодки		
		Тип тормозной системы	№ по каталогу	Толщина изделия, мм	Тип тормозной системы	№ по каталогу	Толщина изделия, мм
OPEL							
Vectra A 1,8i S GL, GT	91-92	ATE	TP.A-038	16,5			
Vectra A 1,8i S GL, GT (ABS)	92-	ATE	TP.A-038	16,5			
Vectra A 2,0 16V 2000 GL 4x4, XE (ABS)	89-	ATE	TP.A-017	18,0			
Vectra A 2,0i All Models (ABS)	89-	ATE	TP.A-017	18,0			
Vectra A 2,0i CD, GT (ABS)	92-	ATE	TP.A-017	18,0			
Vectra A 2,0i GT (ABS)	89-	ATE	TP.A-017	18,0			
Vectra B 1,6i	94-	ATE	TP.A-017	18,0	ATE	TP.A-010	15,5
Vectra B 1,6i 16V	94-	ATE	TP.A-017	18,0	ATE	TP.A-010	15,5
Vectra B 1,7 All Models	94-	ATE	TP.A-017	18,0	ATE	TP.A-010	15,5
Vectra B 1,7 TD	94-	ATE	TP.A-017	18,0	ATE	TP.A-010	15,5
Vectra B 1,8 All Models	94-	ATE	TP.A-017	18,0	ATE	TP.A-010	15,5
Vectra B 1,8i 16V	95-	ATE	TP.A-017	18,0	ATE	TP.A-010	15,5
Vectra B 2,0 All Models	94-	ATE	TP.A-017	18,0	ATE	TP.A-010	15,5
Vectra B 2,0i 16V, 4x4 (ABS)	94-	ATE	TP.A-017	18,0	ATE	TP.A-010	15,5
Vectra B 1,7 D All Models	94-	ATE	TP.A-017	18,0	ATE	TP.A-010	15,5
Vectra B 2,0 D All Models	94-	ATE	TP.A-017	18,0	ATE	TP.A-010	15,5
Vectra B Estate (31_) 1,6i	11/96 – 06/00				ATE	TP.A-010	15,5
Vectra B Estate (31_) 1,6i 16V	11/96 – 07/02				ATE	TP.A-010	15,5
Vectra B Estate (31_) 1,7 TD	11/96 – 12/97				ATE	TP.A-010	15,5
Vectra B Estate (31_) 1,8i 16V	11/96 – 07/03				ATE	TP.A-010	15,5
Vectra B Estate (31_) 2,0 DI 16V	11/96 – 06/00				ATE	TP.A-010	15,5
Vectra B Estate (31_) 2,0 DTI 16V	06/97 – 07/03				ATE	TP.A-010	15,5
Vectra B Estate (31_) 2,0i	11/96 – 02/02				ATE	TP.A-010	15,5
Vectra B Estate (31_) 2,0i 16V	11/96 – 09/00				ATE	TP.A-010	15,5
Vectra B Estate (31_) 2,2 DTI 16V	09/00 – 07/03				ATE	TP.A-010	15,5
Vectra B Estate (31_) 2,2i 16V	09/00 – 07/03				ATE	TP.A-010	15,5
Vectra B Estate (31_) 2,5i V6	11/96 – 09/00				ATE	TP.A-010	15,5
Vectra B Estate (31_) 2,6i V6	09/00 – 07/03				ATE	TP.A-010	15,5
Vectra B Estate (31_) i 500 2,5	05/98 – 09/00				ATE	TP.A-010	15,5
Vita B (73_, 78_, 79_) 1,0i 12V	11/96 – 09/00	ATE	TP.A-038	16,5			
Vita B (73_, 78_, 79_) 1,2i	03/93 – 09/00	ATE	TP.A-038	16,5			
Vita B (73_, 78_, 79_) 1,2i 16V	03/98 – 09/00	ATE	TP.A-038	16,5			
Vita B (73_, 78_, 79_) 1,4i / Si	03/93 – 09/00	ATE	TP.A-038	16,5			

Марка автомобиля	Годы выпуска автомобиля	Передние колодки			Задние колодки		
		Тип тормозной системы	№ по каталогу	Толщина изделия, мм	Тип тормозной системы	№ по каталогу	Толщина изделия, мм
OPEL							
Vita B (73_, 78_, 79_) 1,4i 16V	09/94 – 09/00	ATE	TP.A-038	16,5			
Vita B (73_, 78_, 79_) 1,5 D / TD	03/93 – 09/00	ATE	TP.A-038	16,5			
Vita B (73_, 78_, 79_) 1,6 GSI 16V	03/93 – 09/00	ATE	TP.A-038	16,5			
Vita B (73_, 78_, 79_) 1,6i 16V	09/94 – 09/00	ATE	TP.A-038	16,5			
Vita B (73_, 78_, 79_) 1,7 D	02/96 – 09/00	ATE	TP.A-038	16,5			
Vita C (F08, F68) 1,0	09/00 – 12/09	TRW	TP.A-101	16,8			
Vita C (F08, F68) 1,2	09/00 – 12/09	TRW	TP.A-101	16,8			
Vita C (F08, F68) 1,2 Twinport	07/04 – 12/09	TRW	TP.A-101	16,8			
Vita C (F08, F68) 1,3 CDTI	06/03 – 12/09	TRW	TP.A-101	16,8			
Vita C (F08, F68) 1,4	09/00 – 12/09	TRW	TP.A-101	16,8			
Vita C (F08, F68) 1,4 Twinport	06/03 – 12/09	TRW	TP.A-101	16,8			
Vita C (F08, F68) 1,7 DI / DTI	09/00 – 12/09	TRW	TP.A-101	16,8			
Vita C (F08, F68) 1,8	09/00 – 12/09	TRW	TP.A-101	16,8			
PEUGEOT							
104 1,1 Coupe ZR	79-82	BDX	TP.A-033	15,0			
104 1,1 GR, GC	79-81	BDX	TP.A-033	15,0			
104 1,1 S	79-82	BDX	TP.A-033	15,0			
104 1,2 SR, GC	79-81	BDX	TP.A-033	15,0			
104 1,4 Coupe ZS	80-83	BDX	TP.A-033	15,0			
104 1,4 S	79-83	BDX	TP.A-033	15,0			
106 1,0	96-	BDX	TP.A-011	18,0	BDX	TP.A-067	11,0
106 1,0 XN	91-96	BDX	TP.A-011	18,0			
106 1,0 XN, XR	92-96	BDX	TP.A-011	18,0			
106 1,1	96-	BDX	TP.A-011	18,0			
106 1,1 XN, XR, XT	91-96	BDX	TP.A-011	18,0			
106 1,1i	96-	BDX	TP.A-011	18,0	BDX	TP.A-067	11,0
106 1,3 Rallye	91-96	BDX	TP.A-011	18,0			
106 1,4	96-	BDX	TP.A-011	18,0	BDX	TP.A-067	11,0
106 1,4 XT	91-96	BDX	TP.A-011	18,0			
106 1,4 XND, XRD, XTD	92-94	BDX	TP.A-011	18,0			
106 1,4 XSi	91-94	BDX	TP.A-011	18,0			
106 1,4 i	91-	BDX	TP.A-011	18,0			
106 1,6 i	94-	BDX	TP.A-011	18,0	BDX	TP.A-067	11,0
106 1,6 I Rallye	96-				BDX	TP.A-067	11,0
106 1,6 I GTi	96-				BDX	TP.A-067	11,0
106 1,6 I S16	96-	BDX	TP.A-011	18,0	BDX	TP.A-067	11,0

Марка автомобиля	Годы выпуска автомобиля	Передние колодки			Задние колодки		
		Тип тормозной системы	№ по каталогу	Толщина изделия, мм	Тип тормозной системы	№ по каталогу	Толщина изделия, мм
PEUGEOT							
106 1,5 D	96-	BDX	TP.A-011	18,0	BDX	TP.A-067	11,0
106 Entreprise/Van 1,0	92-96	BDX	TP.A-011	18,0			
106 Entreprise/Van 1,1	92-96	BDX	TP.A-011	18,0			
106 Entreprise/Van 1,4 D	92-94	BDX	TP.A-011	18,0			
106 Entreprise/Van 1,5 D	94-	BDX	TP.A-011	18,0			
106 Entreprise/Van 1,0 i	96-	BDX	TP.A-011	18,0			
106 Entreprise/Van 1,1 i	96-	BDX	TP.A-011	18,0			
205 1,0 XE	84-88	BDX	TP.A-067	18,0			
205 1,0 L, GL	83-85	BDX	TP.A-067	18,0			
205 1,0 TU Eng	87-	BDX	TP.A-067	18,0			
205 1,0 i	92-	BDX	TP.A-067	18,0			
205 1,1	89-94	BDX	TP.A-067	18,0			
205 1,1 GL	86-88	BDX	TP.A-067	18,0			
205 1,1 GL	86-88	BDX	TP.A-067	18,0			
205 1,1 XE, XL	86-90	BDX	TP.A-067	18,0			
205 1,1 XE, XL	86-90	BDX	TP.A-067	18,0			
205 1,1 XE, XL, GL	88-89	BDX	TP.A-067	18,0			
205 1,1 XL	84-86	BDX	TP.A-067	18,0			
205 1,1 GL, GR	83-86	BDX	TP.A-067	18,0			
205 1,1 GL, GR	89-94	BDX	TP.A-067	18,0			
205 1,1 i	89-	BDX	TP.A-067	18,0			
205 1,3	83-90	BDX	TP.A-067	18,0			
205 1,3 Rallye, Racing	88-92	BDX	TP.A-011	18,0			
205 1,4 XR	84-86	BDX	TP.A-067	18,0			
205 1,4 XR	84-86	BDX	TP.A-011	18,0			
205 1,4 XR	86-90	BDX	TP.A-067	18,0			
205 1,4 XR	86-90	BDX	TP.A-011	18,0			
205 1,4 XR, GR	83-86	BDX	TP.A-067	18,0			
205 1,4 XR, GR	83-86	BDX	TP.A-011	18,0			
205 1,4 XS, GR, GT	87-90	BDX	TP.A-067	18,0			
205 1,4 XS, GR, GT	87-90	BDX	TP.A-011	18,0			
205 1,4 XS, GT	86-94	BDX	TP.A-067	18,0			
205 1,4 XS, GT	88-94	BDX	TP.A-011	18,0			
205 1,4 XT	85-87	BDX	TP.A-067	18,0			
205 1,4 XT, GT	83-86	BDX	TP.A-067	18,0			
205 1,5	83-88	BDX	TP.A-067	18,0			
205 1,5	83-88	BDX	TP.A-011	18,0			
205 1,6	83-92	BDX	TP.A-067	18,0			
205 1,6	83-92	BDX	TP.A-011	18,0			
205 1,6 Automatic	87-88	BDX	TP.A-067	18,0			
205 1,6 Automatic GT	86-87	BDX	TP.A-067	18,0			
205 1,6 CJ	92-	BDX	TP.A-011	18,0			
205 1,6 GTi	84-90	BDX	TP.A-011	18,0	BDX	TP.A-067	11,0
205 1,6 XS, GT	90-	BDX	TP.A-011	18,0			
205 1,9 Automatic	89-92	BDX	TP.A-011	18,0			
205 1,9 Automatic, GTi	87-91	BDX	TP.A-011	18,0			

Марка автомобиля	Годы выпуска автомобиля	Передние колодки			Задние колодки		
		Тип тормозной системы	№ по каталогу	Толщина изделия, мм	Тип тормозной системы	№ по каталогу	Толщина изделия, мм
PEUGEOT							
205 1,9 GTi	83-94	BDX	TP.A-011	18,0	BDX	TP.A-067	11,0
205 1,8 Diesel GLD, GRD, SRD	85-90	BDX	TP.A-067	18,0			
205 1,8 Diesel GLD, GRD, SRD	85-90	BDX	TP.A-011	18,0			
205 1,8 Diesel XLD, XRD	84-90	BDX	TP.A-067	18,0			
205 1,8 Diesel XLD, XRD	84-90	BDX	TP.A-011	18,0			
205 1,8 D	91-	BDX	TP.A-011	18,0			
205 1,9 GL, GR, GLD, GRD, XLD, XRD	90-91	BDX	TP.A-067	18,0			
205 1,9 GL, GR, GLD, GRD, XLD, XRD	89-91	BDX	TP.A-011	18,0			
205 1,9 Diesel XL, XR	90-94	BDX	TP.A-067	18,0			
205 1,9 Diesel XL, XR	89-94	BDX	TP.A-011	18,0			
205 II (20 A/C) 1,0	10/87 – 09/98	BDX	TP.A-011	18,0			
205 II (20 A/C) 1,1	10/87 – 09/98	BDX	TP.A-011	18,0			
205 II (20 A/C) 1,4	06/87 – 09/98	BDX	TP.A-011	18,0			
205 II (20 A/C) 1,4 KAT	08/87 – 09/93	BDX	TP.A-011	18,0			
205 II (20 A/C) 1,6	10/87 – 09/98	BDX	TP.A-011	18,0	BDX	TP.A-067	11,0
205 II (20 A/C) 1,6 Aut.	05/90 – 09/98	BDX	TP.A-011	18,0			
205 II (20 A/C) 1,7 Diesel	07/87 – 09/98	BDX	TP.A-011	18,0			
205 II (20 A/C) 1,8 XDT	08/90 – 05/97	BDX	TP.A-011	18,0			
205 II (20 A/C) 1,9 Diesel	10/87 – 09/98	BDX	TP.A-011	18,0			
205 II (20 A/C) 1,9 GTI	10/87 – 09/98				BDX	TP.A-067	11,0
205 II (20 A/C) 1,9 GTI KAT	10/87 – 07/94				BDX	TP.A-067	11,0
205 Cabrio 1,4 CJ	89-93	BDX	TP.A-067	18,0			
205 Cabrio 1,4 CJ	89-93	BDX	TP.A-011	18,0			
205 Cabrio 1,4 CT	86-88	BDX	TP.A-067	18,0			
205 Cabrio 1,4 CT	86-88	BDX	TP.A-011	18,0			
205 Cabrio 1,4i	91-	BDX	TP.A-067	18,0			
205 Cabrio 1,4i	91-	BDX	TP.A-011	18,0			
205 Cabrio 1,6	86-92	BDX	TP.A-067	18,0			
205 Cabrio 1,6	86-92	BDX	TP.A-011	18,0			
205 Cabrio 1,6 CTi	86-90	BDX	TP.A-011	18,0	BDX	TP.A-067	11,0
205 Cabrio 1,9 CTi	87-94	BDX	TP.A-011	18,0	BDX	TP.A-067	11,0
205 Entreprise/Van 1,0	87-93	BDX	TP.A-011	18,0			
205 Entreprise/Van 1,1	85-87	BDX	TP.A-011	18,0	BDX	TP.A-067	11,0
205 Entreprise/Van 1,1 (TU Eng)	87-93	BDX	TP.A-011	18,0			
205 Entreprise/Van 1,3	87-88	BDX	TP.A-011	18,0			
205 Entreprise/Van 1,4	85-93	BDX	TP.A-011	18,0			

Марка автомобиля	Годы выпуска автомобиля	Передние колодки			Задние колодки		
		Тип тормозной системы	№ по каталогу	Толщина изделия, мм	Тип тормозной системы	№ по каталогу	Толщина изделия, мм
PEUGEOT							
205 Entreprise/Van 1,8 D	85-	BDX	TP.A-011	18,0			
205 II (20 A/C) 1,0	10/87 – 09/98	BDX	TP.A-011	18,0			
205 II (20 A/C) 1,1	10/87 – 09/98	BDX	TP.A-011	18,0			
205 II (20 A/C) 1,4	06/87 – 09/98	BDX	TP.A-011	18,0			
205 II (20 A/C) 1,4 KAT	08/87 – 09/93	BDX	TP.A-011	18,0			
205 II (20 A/C) 1,6	10/87 – 09/98	BDX	TP.A-011	18,0	BDX	TP.A-067	11,0
205 II (20 A/C) 1,6 Aut.	05/90 – 09/98	BDX	TP.A-011	18,0			
205 II (20 A/C) 1,7 Diesel	07/87 – 09/98	BDX	TP.A-011	18,0			
205 II (20 A/C) 1,8 XDT	08/90 – 05/97	BDX	TP.A-011	18,0			
205 II (20 A/C) 1,9 Diesel	10/87 – 09/98	BDX	TP.A-011	18,0			
205 II (20 A/C) 1,9 GTI	10/87 – 09/98				BDX	TP.A-067	11,0
205 II (20 A/C) 1,9 GTI KAT	10/87 – 07/94				BDX	TP.A-067	11,0
206 CC (2 D) 1,6 16V	09/00 –				BDX	TP.A-067	11,0
206 CC (2 D) 1,6 HDi 110	04/05 –				BDX	TP.A-067	11,0
206 CC (2 D) 2,0 S16	09/00 –				BDX	TP.A-067	11,0
206 Hatchback (2A/C, T3E) 1,1, ABS(+)	08/98-07/00	BO	TP.A-103	18,0			
206 Hatchback (2A/C, T3E) 1,1, ABS(-)	08/98-07/00	BO	TP.A-103	18,0			
206 Hatchback (2A/C, T3E) 1,1i, ABS(+)	09/98-	BO	TP.A-103	18,0			
206 Hatchback (2A/C, T3E) 1,1i, ABS(-)	09/98-	BO	TP.A-103	18,0			
206 Hatchback (2A/C, T3E) 1,4, 09/00-03/01, Ch.>08882	09/98-	BO	TP.A-103	18,0			
206 Hatchback (2A/C, T3E) 1,6i, -10/00, Ch.>08749	09/98-12/00	BO	TP.A-103	18,0			
206 Hatchback (2A/C, T3E) 1,9D, ABS(+), Ch.>08882	09/98-11/01	BO	TP.A-103	18,0			
206 SW (2 E/K) 1,1	07/02 –				BDX	TP.A-067	11,0
206 SW (2 E/K) 1,4 16V	10/03 –				BDX	TP.A-067	11,0
206 SW (2 E/K) 1,4 HDi	07/02 –				BDX	TP.A-067	11,0
206 SW (2 E/K) 1,6 16V	07/02 –				BDX	TP.A-067	11,0
206 SW (2 E/K) 1,6 HDi 110	05/04 –				BDX	TP.A-067	11,0
206 SW (2 E/K) 2,0 (16V / HDi)	07/02 –				BDX	TP.A-067	11,0
305 1,1	78-87	BDX	TP.A-033	15,0			
305 1,1	78-87	BDX	TP.A-011	18,0			
305 1,3 GL	78-82	BDX	TP.A-033	15,0			
305 1,3 GL	82-87	BDX	TP.A-011	18,0			
305 1,5 GL	85-86	BDX	TP.A-011	18,0			

Марка автомобиля	Годы выпуска автомобиля	Передние колодки			Задние колодки		
		Тип тормозной системы	№ по каталогу	Толщина изделия, мм	Тип тормозной системы	№ по каталогу	Толщина изделия, мм
PEUGEOT							
306 Sedan (7B, N3, N5) 1,8 16V (ST)	06/94 – 05/01				BDX	TP.A-067	11,0
306 Sedan (7B, N3, N5) 2,0	03/97 – 05/01				BDX	TP.A-067	11,0
306 Sedan (7B, N3, N5) 2,0 HDI 90	06/99 – 05/01				BDX	TP.A-067	11,0
306 Sedan (7B, N3, N5) 2,0 S16 (ST)	06/94 – 05/01				BDX	TP.A-067	11,0
306 (7B, N3, N5) 1,4 SL, 05/97-06/00	06/94-05/01	BO	TP.A-103	18,0			
306 (7B, N3, N5) 1,6, ABS(-)	07/00-05/01	BO	TP.A-103	18,0			
306 (7B, N3, N5) 1,6 SR ABS(-)	06/94-10/00	BO	TP.A-103	18,0			
306 Convertible (7D, N3, N5) 1,6, 05/97-06/00	03/94-04/02	BO	TP.A-103	18,0			
306 Hatchback (7A, 7C, N3, N5) 1,4, 05/97, ABS(-)	05/93-05/01	BO	TP.A-103	18,0			
306 Hatchback (7A,7C,N3,N5) 1,6, ABS(-)	05/93-05/01	BO	TP.A-103	18,0			
309 1,1	86-87	BDX	TP.A-011	18,0			
309 1,1 (TU Eng)	89-93	BDX	TP.A-011	18,0			
309 1,1 GL, GR	91-93	BDX	TP.A-011	18,0			
309 1,1 XE	87-88	BDX	TP.A-011	18,0			
309 1,1 XL, XR	91-92	BDX	TP.A-011	18,0			
309 1,3	86-91	BDX	TP.A-011	18,0			
309 1,3 GL, GR, GE	86-89	BDX	TP.A-011	18,0			
309 1,3 XR, XL	87-89	BDX	TP.A-011	18,0			
309 1,4 GL, GR, SX	89-93	BDX	TP.A-011	18,0			
309 1,4 XL, XR, XS, XT	89-93	BDX	TP.A-011	18,0			
309 1,6	87-90	BDX	TP.A-011	18,0			
309 1,6 Automatic	87-90	BDX	TP.A-011	18,0			
309 1,6 XS Injection	89-93	BDX	TP.A-011	18,0			
309 1,6 SX Injection	90-92	BDX	TP.A-011	18,0			
309 1,6 GR, SR	86-89	BDX	TP.A-011	18,0			
309 1,6 XR	87-89	BDX	TP.A-011	18,0			
309 1,6 GT, GR	86-	BDX	TP.A-011	18,0			
309 1,6 GRi, GTi	89-90	BDX	TP.A-011	18,0			
309 1,6 XRi, GTi	87-89	BDX	TP.A-011	18,0			
309 1,9	86-92	BDX	TP.A-011	18,0			
309 1,9	89-91				BDX	TP.A-067	18,0
309 1,9 GT	86-90				BDX	TP.A-067	18,0
309 1,9 SXi, XSi	88-89				BDX	TP.A-067	18,0
309 1,9 GR, SX, XR, XS	89-90				BDX	TP.A-067	18,0
309 1,9 GTi	87-92				BDX	TP.A-067	18,0
309 1,8 Diesel	86-93	BDX	TP.A-011	18,0			
309 1,8 Diesel SXDT, XSDT	90-93	BDX	TP.A-011	18,0			
309 1,9 Diesel GL, GR, XL, XR	87-93	BDX	TP.A-011	18,0			

Марка автомобиля	Годы выпуска автомобиля	Передние колодки			Задние колодки		
		Тип тормозной системы	№ по каталогу	Толщина изделия, мм	Тип тормозной системы	№ по каталогу	Толщина изделия, мм
PEUGEOT							
309 1,9 Diesel GLD, GRD, XLD, XRD	90-91	BDX	TP.A-011	18,0			
309 Entreprise/Van 1,1	89-92	BDX	TP.A-011	18,0			
309 Entreprise/Van 1,4	89-92	BDX	TP.A-011	18,0			
309 Entreprise/Van 1,8 D	86-93	BDX	TP.A-011	18,0			
309 Entreprise/Van 1,9 D	86-93	BDX	TP.A-011	18,0			
405 1,4	87-92	BDX	TP.A-011	18,0	GIR	TP.A-014	15,0
405 1,6 GL, GR	90-92	BDX	TP.A-011	18,0			
405 1,6 Break GL, GR	90-92	BDX	TP.A-011	18,0			
405 1,6 GLi, GRi	90-92	BDX	TP.A-011	18,0	GIR	TP.A-014	15,0
405 1,6 Break GLi, GRi	89-92	BDX	TP.A-011	18,0	GIR	TP.A-014	15,0
405 1,6 Break GL, GR, SR	89-92	BDX	TP.A-011	18,0			
405 1,9	87-92	BDX	TP.A-011	18,0			
405 1,9 GR, SR	87-89				LUC	TP.A-014	15,0
405 1,9 GRi, SRi, 4WD	87-92				LUC	TP.A-014	15,0
405 1,9 Break GL, GR, SR	90-91				LUC	TP.A-014	15,0
405 1,9 Break GRi, SRi	89-91				LUC	TP.A-014	15,0
405 1,9 Break GRi	89-92				LUC	TP.A-014	15,0
405 1,9 Break GRi, 4WD	90-92				LUC	TP.A-014	15,0
405 1,9 MI 16	88-92				LUC	TP.A-014	15,0
405 1,9 MI 16, 4WD	90-92				LUC	TP.A-014	15,0
405 1,9 Break	91-92				LUC	TP.A-014	15,0
405 1,9 Break SRi	91-92				LUC	TP.A-014	15,0
405 1,8 TD GRDT, SRDT	88-92	BDX	TP.A-011	18,0	GIR	TP.A-014	15,0
405 1,8 Break TD, SRDT	88-92	BDX	TP.A-011	18,0			
405 1,9 Diesel GI, GR	87-90	BDX	TP.A-011	18,0	GIR	TP.A-014	15,0
405 1,9 Break Diesel GLD, GRD	89-90	BDX	TP.A-011	18,0			
405 1,4 GL	92-95	BDX	TP.A-011	18,0	GIR	TP.A-014	15,0
405 1,4 Break GL	92-96	BDX	TP.A-011	18,0	GIR	TP.A-014	15,0
405 1,6 Break	92-	BDX	TP.A-011	18,0	GIR	TP.A-014	15,0
405 1,6 GL, GR, SR	92-96	BDX	TP.A-011	18,0	GIR	TP.A-014	15,0
405 1,6 Break GL, GR, SR	92-96	BDX	TP.A-011	18,0			
405 1,6i	92-96	BDX	TP.A-011	18,0			
405 1,6i Break	92-	BDX	TP.A-011	18,0			
405 1,8 GR	92-96	BDX	TP.A-011	18,0	LUC	TP.A-014	15,0
405 1,8 Break GR	92-96	BDX	TP.A-011	18,0	LUC	TP.A-014	15,0
405 1,9i	92-96				LUC	TP.A-014	15,0
405 1,9i Break	92-	BDX	TP.A-011	18,0	LUC	TP.A-014	15,0
405 2,0 MI 16	92-95				LUC	TP.A-014	15,0
405 2,0 SRi	92-96				LUC	TP.A-014	15,0
405 2,0 Break SRi	92-96				LUC	TP.A-014	15,0
405 2,0 Sri 4WD	92-94				LUC	TP.A-014	15,0
405 2,0 Break SRi 4 WD	92-96				LUC	TP.A-014	15,0
405 Van 1,6	92-	BDX	TP.A-011	18,0			
405 I Sedan (15B) 1,4	01/87 – 07/92	BDX	TP.A-011	18,0	GIR	TP.A-014	15,0

Марка автомобиля	Годы выпуска автомобиля	Передние колодки			Задние колодки		
		Тип тормозной системы	№ по каталогу	Толщина изделия, мм	Тип тормозной системы	№ по каталогу	Толщина изделия, мм
PEUGEOT							
405 I Sedan (15B) 1,6	07/87 – 12/92	BDX	TP.A-011	18,0	GIR	TP.A-014	15,0
405 I Sedan (15B) 1,8 Turbo Diesel	03/88 – 12/92				GIR	TP.A-014	15,0
405 I Sedan (15B) 1,9	07/87 – 12/92				GIR	TP.A-014	15,0
405 I Sedan (15B) 1,9 4x4	07/88 – 12/92				GIR	TP.A-014	15,0
405 I Sedan (15B) 1,9 Diesel	03/88 – 12/92	BDX	TP.A-011	18,0	GIR	TP.A-014	15,0
405 I Sedan (15B) 1,9 Injection	07/87 – 12/92				GIR	TP.A-014	15,0
405 I Sedan (15B) 1,9 Sport MI-16	07/87 – 12/92				GIR	TP.A-014	15,0
405 I Sedan (15B) 1,9 Sport MI-16 4x4	04/88 – 12/92				GIR	TP.A-014	15,0
405 II Sedan (4B) 1,4	08/92 – 10/95	BDX	TP.A-011	18,0	GIR	TP.A-014	15,0
405 II Sedan (4B) 1,6	08/92 – 10/95	BDX	TP.A-011	18,0	GIR	TP.A-014	15,0
405 II Sedan (4B) 1,8	08/92 – 10/95	BDX	TP.A-011	18,0	GIR	TP.A-014	15,0
405 II Sedan (4B) 1,9 D / TD	08/92 – 10/95	BDX	TP.A-011	18,0	GIR	TP.A-014	15,0
405 II Sedan (4B) 2,0	08/92 – 10/95				GIR	TP.A-014	15,0
405 II Sedan (4B) 2,0 16V	06/94 – 10/95				GIR	TP.A-014	15,0
405 II Sedan (4B) 2,0 MI-16	08/92 – 10/95				GIR	TP.A-014	15,0
405 II Sedan (4B) 2,0 T 16 X4	08/92 – 10/95				GIR	TP.A-014	15,0
605 2,0 GLi, SLi	90-	BDX	TP.A-050	17,0			
605 2,0 SRi	90-	BDX	TP.A-050	17,0			
605 2,0 SRTi, SVTi	93-	BDX	TP.A-050	17,0			
605 2,0i 16V	94-	BDX	TP.A-050	17,0			
605 2,0i Turbo	91-	BDX	TP.A-050	17,0			
605 2,0 Diesel SLDT, SRDR	90-	BDX	TP.A-050	17,0			
605 2,1 D	92-	BDX	TP.A-050	17,0			
605 2,5 DT	94-	BDX	TP.A-050	17,0	GIR	TP.A-014	15,0
605 3,0 V6 SR, V6 SV	90-	BDX	TP.A-050	17,0			
605 3,0i V6 24SV	91-	ATE	TP.A-061	17,5			
605 3,0i V6 SR	91-	ATE	TP.A-061	17,5			
605 3,0i V6 SR Automatic	91-	ATE	TP.A-061	17,5			
605 3,0 V6 SR	91-	ATE	TP.A-061	17,5			
605 3,0 V6 SV (ABS)	91-	ATE	TP.A-061	17,5			
605 (6B) 2,1 TD 12V (Turbo Diesel)	06/89 – 09/99	BDX	TP.A-050	17,0			
605 Sedan (6B) 2,0 16V (Turbo)	06/89 – 09/99	BDX	TP.A-050	17,0			

Марка автомобиля	Годы выпуска автомобиля	Передние колодки			Задние колодки		
		Тип тормозной системы	№ по каталогу	Толщина изделия, мм	Тип тормозной системы	№ по каталогу	Толщина изделия, мм
PEUGEOT							
605 Sedan (6B) 2,1 D	06/89 – 07/95	BDX	TP.A-050	17,0			
605 Sedan (6B) 2,1 TD 12V	08/94 – 09/99	BDX	TP.A-050	17,0			
605 Sedan (6B) 2,1 Turbo Diesel	06/89 – 09/99	BDX	TP.A-050	17,0			
605 Sedan (6B) 2,5 Turbo Diesel	07/94 – 09/99	BDX	TP.A-050	17,0	GIR	TP.A-014	15,0
605 Sedan (6B) 3,0	10/89 – 09/99	BDX	TP.A-050	17,0			
P4 Jeep 2,1	90-94	ATE	TP.A-034	18,0	ATE	TP.A-034	18,0
P4 Jeep 2,5 D	90-94	ATE	TP.A-034	18,0	ATE	TP.A-034	18,0
4007 (GP_) 2,0 (4x4)	11/10 –	AKE	TP.A-063	15,7			
4007 (GP_) 2,2 HDi	02/07 –	AKE	TP.A-063	15,7			
4007 (GP_) 2,4 16V	01/08 –	AKE	TP.A-063	15,7			
Boxer Box (230L) 2,0 HDi 12/01-	08/01-04/02	BR	TP.A-100	19,0			
Boxer Box (230L) 2,8 HDi Ch.16194400→, Ø280,0 mm	10/00-04/02	BR	TP.A-100	19,0			
Boxer Box (230L) 2,8 HDi Ch.16194400→, Ø300,0 mm	10/00-04/02	BR	TP.A-100	19,0			
Boxer Box (244) 2,0	04/02-	BR	TP.A-100	19,0			
Boxer Box (244) 2,0 HDi	04/02-	BR	TP.A-100	19,0			
Boxer Box (244) 2,0 HDi, Ø280,0 mm	04/02-	BR	TP.A-100	19,0			
Boxer Box (244) 2,0 HDi, Ø300,0 mm	04/02-	BR	TP.A-100	19,0			
Boxer Box (244) 2,8 HDi, Ø280,0 mm	04/02-	BR	TP.A-100	19,0			
Boxer Box (244) 2,8 HDi, Ø300,0 mm	04/02-	BR	TP.A-100	19,0			
Boxer Box (244) 2,8 HDi 4x4, 12/02-, Ø280,0 mm	04/02-	BR	TP.A-100	19,0			
Boxer Box (244) 2,8 HDi 4x4, 12/02-, Ø300,0 mm	04/02-	BR	TP.A-100	19,0			
Boxer Bus (230P) 2,8 HDi 12/01-, Ø280,0 mm	10/00-04/02	BR	TP.A-100	19,0			
Boxer Bus (230P) 2,8 HDi 12/01-, Ø300,0 mm	10/00-04/02	BR	TP.A-100	19,0			
Boxer Bus (244, Z_) 2,0	04/02-	BR	TP.A-100	19,0			
Boxer Bus (244, Z_) 2,0 HDi	04/02-	BR	TP.A-100	19,0			
Boxer Bus (244, Z_) 2,2 HDi, Ø280,0 mm	04/02-	BR	TP.A-100	19,0			
Boxer Bus (244, Z_) 2,2 HDi, Ø300,0 mm	04/02-	BR	TP.A-100	19,0			
Boxer Bus (244, Z_) 2,8 HDi, Ø280,0 mm	04/02-	BR	TP.A-100	19,0			
Boxer Bus (244, Z_) 2,8 HDi, Ø300,0 mm	04/02-	BR	TP.A-100	19,0			
Boxer Bus (244, Z_) 2,8 HDi 4x4, 12/02-, Ø280,0 mm	04/02-	BR	TP.A-100	19,0			
Boxer Bus (244, Z_) 2,8 HDi 4x4, 12/02-, Ø300,0 mm	04/02-	BR	TP.A-100	19,0			
Boxer Flatbed/Chassis (244) 2,0 HDi	04/02-	BR	TP.A-100	19,0			
Boxer Flatbed/Chassis (244) 2,2 HDi, Ø280,0 mm	04/02-	BR	TP.A-100	19,0			

Марка автомобиля	Годы выпуска автомобиля	Передние колодки			Задние колодки		
		Тип тормозной системы	№ по каталогу	Толщина изделия, мм	Тип тормозной системы	№ по каталогу	Толщина изделия, мм
PEUGEOT							
Boxer Flatbed/Chassis (244) 2,2 HDi, Ø300,0 mm	04/02-	BR	TP.A-100	19,0			
Boxer Flatbed/Chassis (244) 2,8 HDi, Ø280,0 mm	04/02-	BR	TP.A-100	19,0			
Boxer Flatbed/Chassis (244) 2,8 HDi, Ø300,0 mm	04/02-	BR	TP.A-100	19,0			
Boxer Flatbed/Chassis (244) 2,8 TD, Ø280,0 mm	12/01-03/05	BR	TP.A-100	19,0			
Boxer Flatbed/Chassis (244) 2,8 TD, Ø300,0 mm	12/01-03/05	BR	TP.A-100	19,0			
Boxer Flatbed/Chassis (ZCT_) 2,0, Ø280,0 mm	12/01	BR	TP.A-100	19,0			
Boxer Flatbed/Chassis (ZCT_) 2,0, Ø300,0 mm	12/01	BR	TP.A-100	19,0			
Boxer Flatbed/Chassis (ZCT_) 2,0i, 12/01-	06/94-04/02	BR	TP.A-100	19,0			
Boxer Flatbed/Chassis (ZCT_) 2,8 HDi, 12/01-, Ø280,0 mm	10/00-04/02	BR	TP.A-100	19,0			
Boxer Flatbed/Chassis (ZCT_) 2,8 HDi, 12/01-, Ø300,0 mm	10/00-04/02	BR	TP.A-100	19,0			
Partner Box (5) 1,4 Bi Fuel, Ø266,0 mm	04/03-	BO	TP.A-095	18,8			
Partner Box (5) 1,4 Bi Fuel, Ø283,0 mm	04/03-	BO	TP.A-095	18,8			
Partner Box (5) 1,9 D 11/01-	05/96-	BO	TP.A-095	18,8			
Partner Box (5) 1,9 D 4x4, Ø266,0 mm	04/04-	BO	TP.A-095	18,8			
Partner Box (5) 1,9 D 4x4, Ø283,0 mm	04/04-	BO	TP.A-095	18,8			
Partner Box (5) 2,0 HDi 4x4, ESP(-), Ø266,0 mm	04/04-	BO	TP.A-095	18,8			
Partner Box (5) 2,0 HDi 4x4, ESP(-), Ø283,0 mm	04/04-	BO	TP.A-095	18,8			
Partner MPV (5F) 1,1 10/01-10/02	06/96	BO	TP.A-095	18,8			
Partner MPV (5F) 1,6 16V, 11/01-	07/01-	BO	TP.A-095	18,8			
Partner MPV (5F) 1,9 D 11/01-	05/96	BO	TP.A-095	18,8			
PORSCHE							
912 Tagra	64-67	ATE	TP.A-001	15,0			
914 1,6 All Models	69-72	ATE	TP.A-001	18,5			
914 1,7i All Models S	64-73	ATE	TP.A-001	18,5			
914 1,8 All Models	73-75	ATE	TP.A-001	18,5			
914 2,0 All Models	69-78	ATE	TP.A-001	18,5			
928 4,5 Coupe	80-	ATE	TP.A-029	20,0			
928 4,5 Coupe	77-85	ATE	TP.A-029	20,0			
928 4,7 S	09/79-07/86	ATE	TP.A-029	20,0			
Cayenne (955) 3,0 TDI -12/09, PR 1LK	02/09	ATE	TP.A-097	18,5/19,8			

Марка автомобиля	Годы выпуска автомобиля	Передние колодки			Задние колодки		
		Тип тормозной системы	№ по каталогу	Толщина изделия, мм	Тип тормозной системы	№ по каталогу	Толщина изделия, мм
PORTARO							
240 D 2,4 All Models	79-89	PER	TP.A-034	18,0			
250 D 2,5 All Models	82-91	PER	TP.A-034	18,0			
280 E 2,7 All Models	79-	PER	TP.A-034	18,0			
300 D 3,0 All Models	79-83	PER	TP.A-034	18,0			
320 D 3,2 All Models	93-	PER	TP.A-034	18,0			
350 D 3,4 All Models	92-	PER	TP.A-034	18,0			
PROTON							
Arena Pick-Up 1,5	05/02 –	SUM	TP.A-054	15,0			
Compact (C9_M) 1,5	07/00 –	SUM	TP.A-054	15,0			
Jumbuck Pick-Up 1,5	05/02 –	SUM	TP.A-054	15,0			
Persona 1,5i (RP)	95	SUM	TP.A-054	15,0			
Persona (C9_M) 1,3	03/96 –	SUM	TP.A-054	15,0			
Persona (C9_M) 1,5	03/96 –	SUM	TP.A-054	15,0			
Persona (C9_M) 313i	03/96 –	SUM	TP.A-054	15,0			
Persona (C9_M) 315 GLi / GLSi	03/96 –	SUM	TP.A-054	15,0			
Persona 300 (C9_M) 1,3	03/96 –	SUM	TP.A-054	15,0			
Persona 300 (C9_M) 1,5	03/96 –	SUM	TP.A-054	15,0			
Persona 300 (C9_M) 313i	03/96 –	SUM	TP.A-054	15,0			
Persona 300 (C9_M) 315 GLi / GLSi	03/96 –	SUM	TP.A-054	15,0			
Persona 400 (C9_S) 1,3	01/94 –	SUM	TP.A-054	15,0			
Persona 400 (C9_S) 1,5	01/94 –	SUM	TP.A-054	15,0			
Persona 400 (C9_S) 2,0 D / TD	05/96 –	SUM	TP.A-054	15,0			
Persona 400 (C9_S) 413	01/94 –	SUM	TP.A-054	15,0			
Persona 400 (C9_S) 415 GLi / GLSi	01/94 –	SUM	TP.A-054	15,0			
Persona 400 (C9_S) 420 GLS D / TD	05/96 –	SUM	TP.A-054	15,0			
Persona Sedan (C9_S) 1,3	01/94 –	SUM	TP.A-054	15,0			
Persona Sedan (C9_S) 1,5	01/94 –	SUM	TP.A-054	15,0			
Persona Sedan (C9_S) 2,0 D / TD	05/96 –	SUM	TP.A-054	15,0			
Persona Sedan (C9_S) 413	01/94 –	SUM	TP.A-054	15,0			
Persona Sedan (C9_S) 415 GLi / GLSi	01/94 –	SUM	TP.A-054	15,0			
Persona Sedan (C9_S) 420 GLS D / TD	05/96 –	SUM	TP.A-054	15,0			
Saloon 1,3, 1,5 Aerodeck (C21, C22)	89-90	AKE	TP.A-053	15,5			
Saloon 1,3, 1,5 Aerodeck (C21, C22)		SUM	TP.A-054	15,0			
Satria (C9_M) 1,3	03/96 –	SUM	TP.A-054	15,0			
Satria (C9_M) 1,5	03/96 –	SUM	TP.A-054	15,0			
Satria (C9_M) 313i	03/96 –	SUM	TP.A-054	15,0			
Satria (C9_M) 315 GLi / GLSi	03/96 –	SUM	TP.A-054	15,0			
Wira 1,3 Saga	93-	SUM	TP.A-054	15,0			
Wira 1,5 12V	93-	SUM	TP.A-054	15,0			
Wira 1,6i 16V SOHC	94-	SUM	TP.A-054	15,0			
Wira (C9_S) 1,3	01/94 –	SUM	TP.A-054	15,0			
Wira (C9_S) 1,5	01/94 –	SUM	TP.A-054	15,0			
Wira (C9_S) 2,0 D / TD	05/96 –	SUM	TP.A-054	15,0			

Марка автомобиля	Годы выпуска автомобиля	Передние колодки			Задние колодки		
		Тип тормозной системы	№ по каталогу	Толщина изделия, мм	Тип тормозной системы	№ по каталогу	Толщина изделия, мм
PROTON							
Wira (C9_S) 413	01/94 –	SUM	TP.A-054	15,0			
Wira (C9_S) 415 GLi / GLSi	01/94 –	SUM	TP.A-054	15,0			
Wira (C9_S) 420 GLS D / TD	05/96 –	SUM	TP.A-054	15,0			
Wira Sedan 1,3	08/00 –	SUM	TP.A-054	15,0			
Wira Sedan 1,5	08/00 –	SUM	TP.A-054	15,0			
PUCH							
230 G 2,3 All Models	79-82	PER	TP.A-034	18,0			
230 GE 2,3 All Models	82-93	PER	TP.A-034	18,0			
240 GD 2,4 All Models	79-86	PER	TP.A-034	18,0			
250 GD 2,5 All Models	86-89	PER	TP.A-034	18,0			
280 GE 2,7 All Models	79-88	PER	TP.A-034	18,0			
290 GD 2,9 All Models (ABS)	92-	PER	TP.A-034	18,0			
300 GD 3,0 All Models	79-83	PER	TP.A-034	18,0			
300 GE 3,0 All Models	90-93	PER	TP.A-034	18,0			
320 G 3,2 All Models	93-	PER	TP.A-034	18,0			
350 G 3,2 All Models (ABS)	93-	PER	TP.A-034	18,0			
350 G 5,0 All Models (ABS)	93-94	PER	TP.A-034	18,0			

Марка автомобиля	Годы выпуска автомобиля	Передние колодки			Задние колодки		
		Тип тормозной системы	№ по каталогу	Толщина изделия, мм	Тип тормозной системы	№ по каталогу	Толщина изделия, мм
RENAULT							
19 I (B/C53_) 1,2	07/88-04/92	TRW	TP.A-090	18,0			
19 I (B/C53_) 1,4 (KAT)	01/88-12/92	TRW	TP.A-090	18,0	BDX	TP.A-067	11,0
19 I (B/C53_) 1,4	-06/89	TRW	TP.A-090	18,0			
19 I (B/C53_) 1,7	09/88-04/92	TRW	TP.A-090	18,0	BDX	TP.A-067	11,0
19 I (B/C53_) 1,8 16V ABS(+)	06/89-04/92	TRW	TP.A-090	18,0	BDX	TP.A-067	11,0
19 I (B/C53_) 1,9 DT ABS(+)	09/90-04/92	TRW	TP.A-090	18,0			
19 I (B/C53_) 1,9 D C534	09/88-04/92	TRW	TP.A-090	18,0	BDX	TP.A-067	11,0
19 I Box (S53_) 1,2 07/88-04/92	01/88-12/92	TRW	TP.A-090	18,0			
19 I Box (S53_) 1,4 07/88-04/92	01/88-12/92	TRW	TP.A-090	18,0			
19 I Box (S53_) 1,9 D	01/88-12/92	TRW	TP.A-090	18,0			
19 I Chamade 1,4 (L532, L53P)	07/88 – 04/92	TRW	TP.A-090	18,0	BDX	TP.A-067	11,0
19 I Chamade 1,7 (L533)	09/88 – 12/92				BDX	TP.A-067	11,0
19 I Chamade 1,7 (L53B, L53C, L53F)	08/88 – 12/92	TRW	TP.A-090	18,0	BDX	TP.A-067	11,0
19 I Chamade 1,8 16V (L53D)	10/89 – 04/92				BDX	TP.A-067	11,0
19 I Chamade 1,9 D (L534, L53J)	10/89 – 04/92				BDX	TP.A-067	11,0
19 I Chamade 1,9 TD (L53K)	09/90 – 04/92	TRW	TP.A-090	18,0	BDX	TP.A-067	11,0
19 I Saloon (L53_) 1,4	07/88-04/92	TRW	TP.A-090	18,0			
19 I Saloon (L53_) 1,4 -06/89	07/88-04/92	TRW	TP.A-090	18,0			
19 I Saloon (L53_) 1,7	07/88-04/92	TRW	TP.A-090	18,0			
19 I Saloon (L53_) 1,9 D ABS(+)	10/89-04/92	TRW	TP.A-090	18,0			
19 II 1,4 (B/C532, B/C535)	01/92 – 12/95	BDX	TP.A-011	18,0	BDX	TP.A-067	11,0
19 II 1,7 (B/C53B)	04/92 – 12/95	BDX	TP.A-011	18,0	BDX	TP.A-067	11,0
19 II (B/C53_) 1,8 -09/94, ABS(+)	04/92-12/95	TRW	TP.A-090	18,0	BDX	TP.A-067	11,0
19 II (B/C53_) 1,8 ABS(+), Ø238,0 mm	04/92-12/95	TRW	TP.A-090	18,0			
19 II (B/C53_) 1,8 ABS(+), Ø259,0 mm	04/92-12/05	TRW	TP.A-090	18,0			
19 II (B/C53_) 1,8 16V 10/94-, ABS(+)	04/92-12/95	TRW	TP.A-090	18,0	BDX	TP.A-067	11,0
19 II (B/C53_) 1,9 D -09/94-, ABS(+)	04/92-12/95	TRW	TP.A-090	18,0	BDX	TP.A-067	11,0
19 II (B/C53_) 1,9 dT ABS(+)	04/92-12/95	TRW	TP.A-090	18,0	BDX	TP.A-067	11,0
19 II Box (S53_) 1,4 10/94-	03/92-12/95	TRW	TP.A-090	18,0			
19 II Box (S53_) 1,9 D -09/94, ABS(+)	03/92-12/95	TRW	TP.A-090	18,0	BDX	TP.A-067	11,0
19 II Box (S53_) 1,9 dT	03/92-12/95	TRW	TP.A-090	18,0	BDX	TP.A-067	11,0
19 II Chamade 1,4 (L532, L535)	04/92 – 12/95	BDX TRW	TP.A-011 TP.A-090	18,0	BDX	TP.A-067	11,0
19 II Chamade 1,7 (L533)	01/93 – 08/95				BDX	TP.A-067	11,0
19 II Chamade 1,7 (L53B, L53C)	04/92 – 12/95	BDX	TP.A-011	18,0	BDX	TP.A-067	11,0
19 II Chamade 1,8 (453A/F)	04/92 – 12/95	TRW	TP.A-090	18,0	BDX	TP.A-067	11,0

Марка автомобиля	Годы выпуска автомобиля	Передние колодки			Задние колодки		
		Тип тормозной системы	№ по каталогу	Толщина изделия, мм	Тип тормозной системы	№ по каталогу	Толщина изделия, мм
RENAULT							
19 II Chamade 1,8 16V (L53D, L53Y, L53V, L538)	04/92 – 12/95	TRW	TP.A-090	18,0	BDX	TP.A-067	11,0
19 II Chamade 1,9 D (L53J)	04/92 – 12/95	BDX TRW	TP.A-011 TP.A-090	18,0	BDX	TP.A-067	11,0
19 II Chamade 1,9 dT (L53T)	04/92 – 12/95	TRW	TP.A-090	18,0	BDX	TP.A-067	11,0
19 II Convertible (D53_, 853_) 1,8, -10/95, ABS(+)	04/92-06/96	TRW	TP.A-090	18,0	BDX	TP.A-067	11,0
19 II Convertible (D53_, 853_) 1,8, 16V, -10/94, ABS(+)	04/92-06/96	TRW	TP.A-090	18,0	BDX	TP.A-067	11,0
19 II Convertible 1,7 (D53C)	04/92 – 09/93				BDX	TP.A-067	11,0
19 II Saloon (L53_) 1,4	04/92-12/95	TRW	TP.A-090	18,0	BDX	TP.A-067	11,0
19 II Saloon (L53_) 1,8 ABS(+), Ø238,0 mm	04/92-12/95	TRW	TP.A-090	18,0	BDX	TP.A-067	11,0
19 II Saloon (L53_) 1,8 ABS(+), Ø259,0 mm	04/92-12/95	TRW	TP.A-090	18,0			
19 II Saloon (L53_) 1,8 ABS(-), Ø238,0 mm	04/92-12/95	TRW	TP.A-090	18,0			
19 II Saloon (L53_) 1,8 Ø259,0 mm	04/92-12/95	TRW	TP.A-090	18,0			
19 II Saloon (L53_) 1,8 16V, 10/94-, ABS(+)	04/92-12/95	TRW	TP.A-090	18,0	BDX	TP.A-067	11,0
19 II Saloon (L53_) 1,9 D	04/92-12/95	TRW	TP.A-090	18,0	BDX	TP.A-067	11,0
19 II Saloon (L53_) 1,9 dT, 10/94-, ABS(+)	04/92-12/95	TRW	TP.A-090	18,0	BDX	TP.A-067	11,0
21 Box (S48) 1,9 D 06/93-	06/08-08/94	TRW	TP.A-090	18,0			
21 Estate (K48) 1,7	06/86-12/93	TRW	TP.A-090	18,0			
21 Estate (K48) 1,9 D 06/93-	03/86-08/94	TRW	TP.A-090	18,0			
21 Estate 2,0 (K483, L48C, K48R)	06/86 – 02/94				BDX	TP.A-033	14,0
21 Estate 2,1 D (4x4) (K480, K/S486, K/S48V, K/S48O)	10/86 – 09/95				BDX	TP.A-033	14,0
21 Estate 2,1 Turbo-D (K48A, K48W, K487, K488)	10/86 – 11/93				BDX	TP.A-033	14,0
21 Estate 2,2 (4x4) (K48K)	06/86 – 12/93				BDX	TP.A-033	14,0
21 Sedan 2,0 (4x4) (L483, L48C, L48R)	03/86 – 06/94				BDX	TP.A-033	14,0
21 Sedan 2,0 Turbo (4x4) (L485, L48L)	04/87 – 10/93				BDX	TP.A-033	14,0
21 Sedan 2,1 D (L48V, L48O)	05/89 – 06/94				BDX	TP.A-033	14,0
21 Sedan 2,1 Turbo-D (L48A, L48W, L487, L488)	03/86 – 06/94				BDX	TP.A-033	14,0
21 Sedan 2,2 (4x4) (L48K)	07/86 – 02/94				BDX	TP.A-033	14,0
25 (B29_) 2,0 12V -03/92	06/88-12/93	TRW	TP.A-090	18,0			

Марка автомобиля	Годы выпуска автомобиля	Передние колодки			Задние колодки		
		Тип тормозной системы	№ по каталогу	Толщина изделия, мм	Тип тормозной системы	№ по каталогу	Толщина изделия, мм
RENAULT							
Alpine 2,7 A310	78-85	BDX	TP.A-033	14,0	BDX	TP.A-033	14,0
Ares (302, 340 л.с.) (Renault Trucks)	-	KNORR SB 7000	TP.A-115	30,0	KNORR SB 7000	TP.A-115	30,0
Clio (B/C 57) 1,1 RL, RN	90-94	BDX	TP.A-011	18,0			
Clio (B/C 57) 1,1 RL, RN	90-92	BDX	TP.A-067	15,0			
Clio (B/C 57) 1,1 Societe	90-96	BDX	TP.A-011	18,0			
Clio (B/C 57) 1,2 RL, RN, RT	91-96	BDX	TP.A-011	18,0	BDX	TP.A-067	11,0
Clio (B/C 57) 1,2i Societe	90-96	BDX	TP.A-011	18,0			
Clio (B/C 57) 1,2 Societe	90-96	BDX	TP.A-011	18,0			
Clio (B/C 57) 1,4 RN, RT	90-96	BDX	TP.A-011	18,0	BDX	TP.A-067	11,0
Clio (B/C 57) 1,4i	91-96	BDX	TP.A-011	18,0	BDX	TP.A-067	11,0
Clio (B/C 57) 1,7 RT, Baccara	90-94				BDX	TP.A-067	11,0
Clio (B/C 57) 1,8	94-				BDX	TP.A-067	11,0
Clio (B/C 57) 1,8 RT	91-96				BDX	TP.A-067	11,0
Clio (B/C 57) 1,8 RSi	93-96				BDX	TP.A-067	11,0
Clio (B/C 57) 1,8 16V	91-96				BDX	TP.A-067	11,0
Clio (B/C 57) 2,0 Williams	93-96				BDX	TP.A-067	11,0
Clio (B/C 57) 1,9 Diesel RL, RN	90-96	BDX	TP.A-011	18,0			
Clio (B/C 57) 1,9 Diesel Societe	90-96	BDX	TP.A-011	18,0			
Clio (57) 1,2i	96-	BDX	TP.A-011	18,0			
Clio (57) 1,2i Societe	96-	BDX	TP.A-011	18,0			
Clio (57) 1,4	96-	BDX	TP.A-011	18,0			
Clio (57) 1,4i	96-	BDX	TP.A-011	18,0	BDX	TP.A-067	11,0
Clio (57) 1,8i	96-				BDX	TP.A-067	11,0
Clio (57) 1,9 D	96-	BDX	TP.A-011	18,0	BDX	TP.A-067	11,0
Clio I (BC57_, 5/357_) 1,1	01/91-09/98	TRW	TP.A-090	18,0			
Clio I (BC57_, 5/357_) 1,1, -04/92	01/91-09/98	TRW	TP.A-090	18,0			
Clio I (BC57_, 5/357_) 1,1, 04/92-	01/91-09/98	TRW	TP.A-090	18,0			
Clio I (BC57_, 5/357_) 1,2	05/90-09/98	TRW	TP.A-090	18,0	BDX	TP.A-067	11,0
Clio I (BC57_, 5/357_) 1,2, -06/96	05/90-09/98	TRW	TP.A-090	18,0	BDX	TP.A-067	11,0
Clio I (BC57_, 5/357_) 1,2, 04/92-	05/90-09/98	TRW	TP.A-090	18,0			
Clio I (BC57_, 5/357_) 1,2, ABS(+)	05/90-09/98	TRW	TP.A-090	18,0			
Clio I (BC57_, 5/357_) 1,2	05/90-09/98	TRW	TP.A-090	18,0			
Clio I (BC57_, 5/357_) 1,4, 04/92-	01/91-09/98	TRW	TP.A-090	18,0	BDX	TP.A-067	11,0
Clio I (BC57_, 5/357_) 1,8, -05/94	08/90-09/98	TRW	TP.A-090	18,0	BDX	TP.A-067	11,0
Clio I (BC57_, 5/357_) 1,8 16V, 11/92-, ABS(+)	01/91-03/96	TRW	TP.A-090	18,0	BDX	TP.A-067	11,0
Clio I (BC57_, 5/357_) 1,8 RSi, -05/94	01/93-09/98	TRW	TP.A-090	18,0	BDX	TP.A-067	11,0
Clio I (BC57_, 5/357_) 1,8		TRW	TP.A-090	18,0			
Clio I (BC57_, 5/357_) 1,9 D, -02/98	01/91-09/98	TRW	TP.A-090	18,0	BDX	TP.A-067	11,0
Clio I (BC57_, 5/357_) 1,9 D, 04/92-04/96, ABS(+)	01/91-09/98	TRW	TP.A-090	18,0			
Clio I (BC57_, 5/357_) 1,9 D, Ø238,0 mm	01/91-09/98	TRW	TP.A-090	18,0			
Clio I (BC57_, 5/357_) 1,9 D, Ø259,0 mm	01/91-09/98	TRW	TP.A-090	18,0			

Марка автомобиля	Годы выпуска автомобиля	Передние колодки			Задние колодки		
		Тип тормозной системы	№ по каталогу	Толщина изделия, мм	Тип тормозной системы	№ по каталогу	Толщина изделия, мм
RENAULT							
Clio I (BC57_, 5/357_) 2,0 Williams, -04/96, ABS(+)	01/94-09/98	TRW	TP.A-090	18,0			
Clio I (BC57_, 5/357_) 1,4 06/94-02/98	01/91-09/98	TRW	TP.A-090	18,0			
Clio I (BC57_, 5/357_) 1,4 06/94-	01/91-09/98	TRW	TP.A-090	18,0			
Clio I (BC57_, 5/357_) 1,4, ABS(+)	01/91-09/98	TRW	TP.A-090	18,0			
Clio I (BC57_, 5/357_) 1,4, ABS(-)	01/91-09/98	TRW	TP.A-090	18,0			
Clio I (BC57_, 5/357_) 1,8, -02/98	08/90-09/98	TRW	TP.A-090	18,0			
Clio I (BC57_, 5/357_) 1,8, 06/94-02/98	08/90-09/98	TRW	TP.A-090	18,0			
Clio I (BC57_, 5/357_) 1,8, 06/94-	08/90-09/98	TRW	TP.A-090	18,0			
Clio I (BC57_, 5/357_) 1,8 RSi, -02/98, ABS(+)	01/93-09/98	TRW	TP.A-090	18,0			
Clio I (BC57_, 5/357_) 1,9 D, 05/96-02/98, ABS(+)	01/91-09/98	TRW	TP.A-090	18,0			
Clio I (BC57_, 5/357_) 1,9 D, Ø238,0 mm	01/91-09/98	TRW	TP.A-090	18,0			
Clio I (BC57_, 5/357_) 1,9 D, Ø259,0 mm	01/91-09/98	TRW	TP.A-090	18,0			
Clio I (BC57_, 5/357_) 1,9 D, 03/98-, ABS(+)/ Ø238,0 mm	01/91-09/98	TRW	TP.A-090	18,0			
Clio I (BC57_, 5/357_) 1,9 D, 03/98-, ABS(+)/ Ø259,0 mm	01/91-09/98	TRW	TP.A-090	18,0			
Clio I Box (S57_) 1,1 06/94-05/95	01/91-09/98	TRW	TP.A-090	18,0			
Clio I Box (S57_) 1,2 -06/96	01/91-09/98	TRW	TP.A-090	18,0			
Clio I Box (S57_) 1,2 06/94-02/98	01/91-09/98	TRW	TP.A-090	18,0			
Clio I Box (S57_) 1,2 07/96	01/91-09/98	TRW	TP.A-090	18,0			
Clio I Box (S57_) 1,9 D	01/91-09/98	TRW	TP.A-090	18,0			
Clio I Box (S57_) 1,9 RND	04/96-02/98	TRW	TP.A-090	18,0			
Clio I Box (S57_) 1,5 dCi ABS(+)	06/01-	TRW	TP.A-090	18,0			
Clio I Box (S57_) 1,5 ABS(-)	06/01-	TRW	TP.A-090	18,0			
Clio I Box (S57_) 1,6 16V 06/01-	09/98-	TRW	TP.A-090	18,0			
Clio I Electric (B/C57_, 5/357_)	05/96 – 02/98	BDX TRW	TP.A-011 TP.A-090	18,0			
Clio II (BBO/1/2_, CBO/1/2_) 1,2 ABS(-)	09/98-	TRW	TP.A-090	18,0	BDX	TP.A-067	11,0
Clio II (BBO/1/2_, CBO/1/2_) 1,2 16V, ABS(-)	06/01-	TRW	TP.A-090	18,0			
Clio II (BBO/1/2_, CBO/1/2_) 1,2 ABS(+)	09/98-	TRW	TP.A-090	18,0	BDX	TP.A-067	11,0
Clio II (BBO/1/2_, CBO/1/2_) 1,2 16V, ABS(+), Ø238,0 mm	06/01-	TRW	TP.A-090	18,0	BDX	TP.A-067	11,0
Clio II (BBO/1/2_, CBO/1/2_) 1,2 16V, ABS(+), Ø259,0 mm	06/01-	TRW	TP.A-090	18,0			
Clio II (BBO/1/2_, CBO/1/2_) 1,4, ABS(+)	09/98-05/05	TRW	TP.A-090	18,0			
Clio II (BBO/1/2_, CBO/1/2_) 1,4, ABS(-)	09/98-05/05	TRW	TP.A-090	18,0			
Clio II (BBO/1/2_, CBO/1/2_) 1,4 16V, ABS(+)	10/99-	TRW	TP.A-090	18,0	BDX	TP.A-067	11,0
Clio II (BBO/1/2_, CBO/1/2_) 1,4 16V, ABS(-)	10/99-	TRW	TP.A-090	18,0	BDX	TP.A-067	11,0

Марка автомобиля	Годы выпуска автомобиля	Передние колодки			Задние колодки		
		Тип тормозной системы	№ по каталогу	Толщина изделия, мм	Тип тормозной системы	№ по каталогу	Толщина изделия, мм
RENAULT							
Clio II (BBO/1/2_, CBO/1/2_) 1,5 D	08/04-	TRW	TP.A-090	18,0			
Clio II (BBO/1/2_, CBO/1/2_) 1,5 dCi	06/01-	TRW	TP.A-090	18,0	BDX	TP.A-067	11,0
Clio II (BBO/1/2_, CBO/1/2_) 1,6, ABS(+)	09/98-05/05	TRW	TP.A-090	18,0			
Clio II (BBO/1/2_, CBO/1/2_) 1,6, ABS(-)	09/98-05/05	TRW	TP.A-090	18,0			
Clio II (BBO/1/2_, CBO/1/2_) 1,6 16V, -05/01	09/98-	TRW	TP.A-090	18,0	BDX	TP.A-067	11,0
Clio II (BBO/1/2_, CBO/1/2_) 1,6 16V, 06/01-	09/98-	TRW	TP.A-090	18,0			
Clio II (BBO/1/2_, CBO/1/2_) 1,9 D, ABS(+)	09/98-05/05	TRW	TP.A-090	18,0			
Clio II (BBO/1/2_, CBO/1/2_) 1,9 D, ABS(-)	09/98-05/05	TRW	TP.A-090	18,0			
Clio II (BBO/1/2_, CBO/1/2_) 1,9 dTi	12/99-05/05	TRW	TP.A-090	18,0			
Clio II (BBO/1/2_, CBO/1/2_) 2,0 16V Sport	02/00-	TRW	TP.A-090/099	18,0	BDX	TP.A-067	11,0
Clio II (BBO/1/2_, CBO/1/2_) 2,0 16V Sport	01/04-	TRW	TP.A-090/099	18,0	BDX	TP.A-067	11,0
Clio II Box (SB 0/1/2_) 1,1, 07/98-	09/98-	TRW	TP.A-090	18,0			
Clio II Box (SB 0/1/2_) 1,1 -10/01, ABS(-)	09/98-	TRW	TP.A-090	18,0			
Clio II Box (SB 0/1/2_) 1,1, 06/01-	09/98-	TRW	TP.A-090	18,0			
Clio II Box (SB 0/1/2_) 1,1 ABS(+)	09/98-	TRW	TP.A-090	18,0			
Clio II Box (SB 0/1/2_) 1,1 ABS(+)	09/98-	TRW	TP.A-090	18,0			
Clio II Box (SB 0/1/2_) 1,2 SBOA, ABS(+)	03/99-10/03	TRW	TP.A-090	18,0			
Clio II Box (SB 0/1/2_) 1,2 SBOA, ABS(-)	03/99-10/03	TRW	TP.A-090	18,0			
Clio II Box (SB 0/1/2_) 1,2 SBOK	03/99-10/03	TRW	TP.A-090	18,0			
Clio II Box (SB 0/1/2_) 1,5 dCi	06/01-	TRW	TP.A-090	18,0			
Clio II Box (SB 0/1/2_) 1,6	11/03-	TRW	TP.A-090	18,0			
Clio II Box (SB 0/1/2_) 1,9 D, ABS(+)	09/98-	TRW	TP.A-090	18,0			
Clio II Box (SB 0/1/2_) 1,9 D, ABS(-)	09/98-	TRW	TP.A-090	18,0			
Clio II Box (SB 0/1/2_) 1,9 DTi, ABS(+)	02/00-05/01	TRW	TP.A-090	18,0			
Clio II Box (SB 0/1/2_) 1,9 DTi, ABS(-)	02/00-05/01	TRW	TP.A-090	18,0			
Espace (J11/13) 2,0 4WD	88-90				BDX	TP.A-033	14,0
Espace (J11/13) 2,1 GTX, TXE	86-90				BDX	TP.A-033	14,0
Espace (J11/13) 2,0i	85-91				BDX	TP.A-033	14,0
Espace (J11/13) 2,1 4GTX, TXE WD	88-91				BDX	TP.A-033	14,0
Espace (J11/13) 2,1 2000-1 4WD	88-91				BDX	TP.A-033	14,0
Espace (J11/13) 2,1 Turbo Diesel, DX	88-90				BDX	TP.A-033	14,0
Espace (J63) 2,0	91-96				BDX	TP.A-033	14,0
Espace (J63) 2,2 RN, RT, RXE	91-96				BDX	TP.A-033	14,0
Espace (J63) 2,2 RT, RXE, 4WD	91-96				BDX	TP.A-033	14,0
Espace (J63) 2,2 Societe	91-96				BDX	TP.A-033	14,0
Espace (J63) 2,9 RT, RXE, V6	91-96				BDX	TP.A-033	14,0
Espace (J63) 2,1 RN, RT, RXE, TD	91-96				BDX	TP.A-033	14,0
Espace (J63) 2,1 Societe TD	91-96				BDX	TP.A-033	14,0
Espace (J63) 2,1 TD	94-				BDX	TP.A-033	14,0

Марка автомобиля	Годы выпуска автомобиля	Передние колодки			Задние колодки		
		Тип тормозной системы	№ по каталогу	Толщина изделия, мм	Тип тормозной системы	№ по каталогу	Толщина изделия, мм
RENAULT							
Espace I (J11_) 2,0i Quadra, -12/90, ABS(+)	03/88-12/92	TRW	TP.A-90	18,0	BDX	TP.A-033	14,0
Espace I (J11_) 2,1 TD 01/80-	10/84-12/90						
Espace I (J11_) 2,2 Quadra	06/87-12/90				BDX	TP.A-033	14,0
Espace I (J11_) 2,2 Quadra, ABS(+)	06/87-12/90						
Express 1,0	85-91	BDX	TP.A-067	15,0			
Express 1,0	85-91	BDX	TP.A-011	18,0			
Express 1,0	85-91	BDX	TP.A-067	18,0			
Express 1,1	85-91	BDX	TP.A-067	15,0			
Express 1,1	85-91	BDX	TP.A-011	18,0			
Express 1,1	85-91	BDX	TP.A-067	18,0			
Express 1,1	91-	BDX	TP.A-067	18,0	BDX	TP.A-011	15,0
Express 1,2	91-	BDX	TP.A-067	18,0	BDX	TP.A-011	15,0
Express 1,4	85-91	BDX	TP.A-067	18,0			
Express 1,4	91-	BDX	TP.A-067	18,0			
Express 1,4	91-	BDX	TP.A-011	18,0			
Express 1,4i	86-91	BDX	TP.A-067	18,0			
Express 1,4i	91-	BDX	TP.A-067	18,0			
Express 1,4i	91-	BDX	TP.A-011	18,0			
Express 1,6 D	85-91	BDX	TP.A-067	18,0			
Express 1,6 D	91-	BDX	TP.A-011	18,0			
Express 1,6 D	91-	BDX	TP.A-067	18,0			
Express 1,6 D	91-	BDX	TP.A-011	18,0			
Express 1,9 D	91-	BDX	TP.A-067	18,0			
Express 1,9 D	91-	BDX	TP.A-011	18,0			
Express Box (F40_, G40_) 1,0	09/85 – 05/92	BDX	TP.A-011 TP.A-067	18,0 15,0			
Express Box (F40_, G40_) 1,1	09/85 – 08/91	BDX	TP.A-011 TP.A-067	18,0 15,0			
Express Box (F406, G40A) 1,2	09/91 – 11/98	BDX TRW	TP.A-011 TP.A-090	18,0			
Express Box (F407) 1,4 KAT	08/88 – 03/98	BDX TRW	TP.A-011 TP.A-090	18,0			
Express Box 1,4 (F40D, F40M, F40U, F40V)	03/86 – 03/98	BDX TRW	TP.A-011 TP.A-090	18,0			
Express Box 1,6 D (F404)	03/86 – 08/98	BDX TRW	TP.A-011 TP.A-090	18,0			
Express Box 1,9 D (F40R)	09/94 – 03/98	BDX TRW	TP.A-011 TP.A-090	18,0			
Extra 1,0	85-91	BDX	TP.A-011	18,0			
Extra 1,1	85-91	BDX	TP.A-011	18,0			
Extra 1,2	91-	BDX	TP.A-011	18,0			
Extra 1,4	85-91	BDX	TP.A-011	18,0			
Extra 1,4	91-	BDX	TP.A-011	18,0			
Extra 1,4i (Cat)	85-91	BDX	TP.A-011	18,0			
Extra 1,4i (Cat)	91-	BDX	TP.A-011	18,0			
Extra 1,6 D	85-91	BDX	TP.A-011	18,0			
Extra 1,6 D	91-	BDX	TP.A-011	18,0			
Extra 1,9 D	91-	BDX	TP.A-011	18,0			

Марка автомобиля	Годы выпуска автомобиля	Передние колодки			Задние колодки		
		Тип тормозной системы	№ по каталогу	Толщина изделия, мм	Тип тормозной системы	№ по каталогу	Толщина изделия, мм
RENAULT							
Extra Box (F40_, G40_) 1,0	09/85 – 05/92	BDX	TP.A-011 TP.A-067	18,0 15,0			
Extra Box (F40_, G40_) 1,1	09/85 – 08/91	BDX	TP.A-011 TP.A-067	18,0 15,0			
Extra Box 1,2 (F406, G40A)	09/91 – 03/98	BDX TRW	TP.A-011 TP.A-090	18,0			
Extra Box 1,4 (F407) KAT	08/88 – 03/98	BDX TRW	TP.A-011 TP.A-090	18,0			
Extra Box 1,4 (F40D, F40M, F40U, F40V)	03/86 – 03/98	BDX TRW	TP.A-011 TP.A-090	18,0			
Extra Box 1,6 D (F404)	03/86 – 08/98	BDX TRW	TP.A-011 TP.A-090	18,0			
Extra Box 1,9 D (F40R)	09/94 – 03/98	BDX TRW	TP.A-011 TP.A-090	18,0			
Fuego Coupe 1,4 TL, GTL	80-85	BDX	TP.A-011	18,0			
Fuego Coupe 1,6 GTL,TS, GTS	81-85	BDX	TP.A-011	18,0			
Fuego Coupe 2,0 TX, GTX	80-85	BDX	TP.A-011	18,0			
Fuego Coupe 2,2 GTX	85-86	BDX	TP.A-011	18,0			
Fuego (136-) 1,6 Turbo (1365)	08/83-10/85				BDX	TP.A-033	14,0
Grand Scenic II (JM0/1_) 2,0	04/04 –	BO	TP.A-094	18,3			
Grand Scenic II (JM 0/1-) (04/04-) 1,9 dCi	-07/05	BO	TP.A-094	18,3			
Grand Scenic II (JM 0/1-), 1,5 dCi	04/04-	BO	TP.A-094	18,3			
Grand Scenic II (JM 0/1-) (04/04-), 1,6 Ø280 mm	-10/05	BO	TP.A-094	18,3			
Grand Scenic II (JM 0/1-) (04/04-), 1,6 Ø300 mm	-10/05	BO	TP.A-094	18,3			
Grand Scenic II (JM 0/1-) (04/04-), 1,9	-10/05	BO	TP.A-094	18,3			
Grand Scenic II (JM 0/1-) (04/04-), 1,9 DCi	04/04-	BO	TP.A-094	18,3			
Kangoo (KC 0/1_) 1,6 16V 4x4	10/01-	BO	TP.A-094	18,3			
Kangoo (KC 0/1_) 1,9 dCi 4x4, -06/03, Ø280,0 mm	10/01-	BO	TP.A-094	18,3			
Kangoo (KC 0/1_) 1,9 dTi	02/00-	BO	TP.A-094	18,3			
Kangoo (KC 0/1_) 1,2	08/97-	BO	TP.A-103	18,0			
Kangoo (KC 0/1_) 1,2 -06/01	08/97-	BO	TP.A-103	18,0			
Kangoo (KC 0/1_) 1,2 07/98-	08/97-	BO	TP.A-103	18,0			
Kangoo (KC 0/1_) 1,2 16V	06/01-	BO	TP.A-103	18,0			
Kangoo (KC 0/1_) 1,4	08/97-	BO	TP.A-103	18,0			
Kangoo (KC 0/1_) 1,5 dCi	12/01-	BO	TP.A-103	18,0			
Kangoo (KC 0/1_) 1,6	09/99-06/01	BO	TP.A-103	18,0			
Kangoo (KC 0/1_) 1,6 16V	06/01-	BO	TP.A-103	18,0			
Kangoo (KC 0/1_) 1,6 16V Bivalent	06/05-	BO	TP.A-103	18,0			
Kangoo (KC 0/1_) 1,9 dTi, -06/01, Ø238,0 mm	02/00-	BO	TP.A-103	18,0			
Kangoo (KC 0/1_) 1,9 dTi, -06/01, Ø280,0 mm	02/00-	BO	TP.A-103	18,0			
Kangoo (KC 0/1_) 1,9 D55, Ø238,0 mm	08/97-	BO	TP.A-103	18,0			
Kangoo (KC 0/1_) 1,9 D55, Ø259,0 mm	08/97-	BO	TP.A-103	18,0			
Kangoo (KC 0/1_) 1,9 D65, Ø238,0 mm	08/97-	BO	TP.A-103	18,0			
Kangoo (KC 0/1_) 1,9 D65, Ø259,0 mm	08/97-	BO	TP.A-103	18,0			
Kangoo (KC 0/1_) 1,9 dCi 4x4	10/01-	BO	TP.A-103	18,0			

Марка автомобиля	Годы выпуска автомобиля	Передние колодки			Задние колодки		
		Тип тормозной системы	№ по каталогу	Толщина изделия, мм	Тип тормозной системы	№ по каталогу	Толщина изделия, мм
RENAULT							
Laguna (B56_, 556_) 1,6 16V, 05/99-	11/97-03/01	TRW	TP.A-099	18,0			
Laguna (B56_, 556_) 1,8 04/99-	11/93-03/01	TRW	TP.A-099	18,0			
Laguna (B56_, 556_) 1,8 04/99-, ABS(+)	11/93-03/01	TRW	TP.A-099	18,0			
Laguna (B56_, 556_) 1,8 16V, 04/99	04/98-03/01	TRW	TP.A-099	18,0			
Laguna (B56_, 556_) 1,9 dCi/dP	09/99-03/01	TRW	TP.A-099	18,0			
Laguna (B56_, 556_) 1,9 dTi, 04/99-	10/97-03/01	TRW	TP.A-099	18,0			
Laguna (B56_, 556_) 2,0 04/99, Ø262,0 mm	11/93-03/01	TRW	TP.A-099	18,0			
Laguna (B56_, 556_) 2,0 04/99, Ø280,0 mm	11/93-03/01	TRW	TP.A-099	18,0			
Laguna (B56_, 556_) 2,0, Ø262,0 mm	11/93-03/01	TRW	TP.A-099	18,0			
Laguna (B56_, 556_) 2,0, Ø280,0 mm	11/93-03/01	TRW	TP.A-099	18,0			
Laguna (B56_, 556_) 2,0 16V	06/97-03/01	TRW	TP.A-099	18,0			
Laguna (B56_, 556_) 2,0 16V, 04/99	06/97-03/01	TRW	TP.A-099	18,0			
Laguna (B56_, 556_) 2,2 D, 04/99-	11/93-03/01	TRW	TP.A-099	18,0			
Laguna (B56_, 556_) 2,2 dT, 04/99-	03/96-03/01	TRW	TP.A-099	18,0			
Laguna (B56_, 556_) 3,0 04/99-	11/93-03/01	TRW	TP.A-099	18,0			
Laguna (B56_, 556_) 3,0 24V, 04/99-	03/97-03/01	TRW	TP.A-099	18,0			
Laguna Estate (K56_) 1,6 16V, 04/99-	11/97-03/01	TRW	TP.A-099	18,0			
Laguna Estate (K56_) 1,8, 04/99	09/95-03/01	TRW	TP.A-099	18,0			
Laguna Estate (K56_) 1,8, 04/99-, ABS(+)	09/95-03/01	TRW	TP.A-099	18,0			
Laguna Estate (K56_) 1,8 16V, 04/99-	04/98-03/01	TRW	TP.A-099	18,0			
Laguna Estate (K56_) 1,9 dCi	09/99-03/01	TRW	TP.A-099	18,0			
Laguna Estate (K56_) 2,0 04/99-, Ø262,0 mm	09/95-03/01	TRW	TP.A-099	18,0			
Laguna Estate (K56_) 2,0 04/99-, Ø280,0 mm	09/95-03/01	TRW	TP.A-099	18,0			
Laguna Estate (K56_) 2,0 16V	09/95-03/01	TRW	TP.A-099	18,0			
Laguna Estate (K56_) 2,0 16V, 04/99-	09/95-03/01	TRW	TP.A-099	18,0			
Laguna Estate (K56_) 2,2 D, 04/99-	09/95-03/01	TRW	TP.A-099	18,0			
Laguna Estate (K56_) 2,2 dT, 04/99-	03/96-03/01	TRW	TP.A-099	18,0			
Laguna Estate (K56_) 3,0, 04/99	02/96-03/01	TRW	TP.A-099	18,0			
Laguna Estate (K56_) 3,0 24V, 04/99-	03/97-03/01	TRW	TP.A-099	18,0			
Laguna Grandtour 1,6 16V (K568)	11/97 – 03/01	TRW	TP.A-099	18,0			
Laguna Grandtour 1,8 (K56Z, K56S/T/0)	09/95 – 03/01	TRW	TP.A-099	18,0			
Laguna Grandtour 1,8 16V (K563, K564)	04/98 – 03/01	TRW	TP.A-099	18,0			
Laguna Grandtour 1,9 dCi (K56W)	09/99 – 03/01	TRW	TP.A-099	18,0			
Laguna Grandtour 1,9 dTi (K56J)	10/97 – 03/01	TRW	TP.A-099	18,0			
Laguna Grandtour 2,0 (K56C/H)	09/95 – 03/01	TRW	TP.A-099	18,0			
Laguna Grandtour 2,0 16V (A56A/B, K56D/M)	09/95 – 03/01	TRW	TP.A-099	18,0			
Laguna Grandtour 2,2 D (K56F/2, S56F)	09/95 – 03/01	TRW	TP.A-099	18,0			

Марка автомобиля	Годы выпуска автомобиля	Передние колодки			Задние колодки		
		Тип тормозной системы	№ по каталогу	Толщина изделия, мм	Тип тормозной системы	№ по каталогу	Толщина изделия, мм
RENAULT							
Laguna Grandtour 2,2 dT (K569)	03/96 – 03/01	TRW	TP.A-099	18,0			
Laguna Grandtour 3,0 (K56R, K565)	02/96 – 03/01	TRW	TP.A-099	18,0			
Laguna Grandtour 3,0 24V (K56V)	03/97 – 03/01	TRW	TP.A-099	18,0			
Laguna Nevada 1,6 16V (K568)	11/97 – 03/01	TRW	TP.A-099	18,0			
Laguna Nevada 1,8 (K56Z, K56S/T/0)	09/95 – 03/01	TRW	TP.A-099	18,0			
Laguna Nevada 1,8 16V (K563, K564)	04/98 – 03/01	TRW	TP.A-099	18,0			
Laguna Nevada 1,9 dCi (K56W)	09/99 – 03/01	TRW	TP.A-099	18,0			
Laguna Nevada 1,9 dTi (K56J)	10/97 – 03/01	TRW	TP.A-099	18,0			
Laguna Nevada 2,0 (K56C/H)	09/95 – 03/01	TRW	TP.A-099	18,0			
Laguna Nevada 2,0 16V (A56A/B, K56D/M)	09/95 – 03/01	TRW	TP.A-099	18,0			
Laguna Nevada 2,2 D (K56F/2, S56F)	09/95 – 03/01	TRW	TP.A-099	18,0			
Laguna Nevada 2,2 dT (K569)	03/96 – 03/01	TRW	TP.A-099	18,0			
Laguna Nevada 3,0 (K56R, K565)	02/96 – 03/01	TRW	TP.A-099	18,0			
Laguna Nevada 3,0 24V (K56V)	03/97 – 03/01	TRW	TP.A-099	18,0			
Logan (LS_) 1,4 ABS(+)	09/04	TRW	TP.A-090	18,0			
Logan (LS_) 1,4 ABS(-)	09/04	TRW	TP.A-090	18,0			
Logan (LS_) 1,5 dCi ABS(+)	04/07-	TRW	TP.A-090	18,0			
Logan (LS_) 1,5 dCi ABS(-)	04/07-	TRW	TP.A-090	18,0			
Logan (LS_) 1,6 ABS(-)	09/04	TRW	TP.A-090	18,0			
Logan (LS_) 1,6 ABS(+), Ø238,0 mm	09/04	TRW	TP.A-090	18,0			
Logan (LS_) 1,6 ABS(+), Ø259,0 mm	09/04	TRW	TP.A-090	18,0			
Logan Estate (KS_) 1,5 dCi	04/07 –	TRW	TP.A-090	18,0			
Megane 2,0 16V Coach	96-				BDX	TP.A-067	11,0
Megane Scenic 1,4i (JA0E)	01/97 – 09/99	TRW	TP.A-090	18,0			
Megane Scenic 1,6 16V (JA0B, JA04, JA11)	04/98 – 10/99	TRW	TP.A-099	18,0			
Megane Scenic 1,6 e (JA0F)	10/96 – 10/99	TRW	TP.A-090 TP.A-099	18,0			
Megane Scenic 1,6i (JA0L)	01/97 – 09/99	TRW	TP.A-099	18,0			
Megane Scenic 1,9 D (JA0J)	03/97 – 09/99	TRW	TP.A-099	18,0			
Megane Scenic 2,0i (JA0G)	01/97 – 09/99	TRW	TP.A-090 TP.A-099	18,0	GIR	TP.A-014	15,0
Megane I (BA 0/1_) 1,6 16V	03/99-	TRW	TP.A-099	18,0	BDX	TP.A-067	11,0

Марка автомобиля	Годы выпуска автомобиля	Передние колодки			Задние колодки		
		Тип тормозной системы	№ по каталогу	Толщина изделия, мм	Тип тормозной системы	№ по каталогу	Толщина изделия, мм
RENAULT							
Megane I (BA 0/1_) 1,8 16V, -08/02	01/01-	TRW	TP.A-099	18,0	BDX	TP.A-067	11,0
Megane I (BA 0/1_) 1,9 D	10/96-02/99	TRW	TP.A-099	18,0			
Megane I (BA 0/1_) 1,9 DCi	03/99	TRW	TP.A-099	18,0	BDX	TP.A-067	11,0
Megane I (BA 0/1_) 1,9 dTi, 03/02-, Ø259,0 mm	03/97-	TRW	TP.A-099	18,0			
Megane I (BA 0/1_) 1,9 dTi, 03/02-, Ø280,0 mm	03/97-	TRW	TP.A-099	18,0			
Megane I (BA 0/1_) 1,9 dTi, Ø259,0 mm	03/97-	TRW	TP.A-099	18,0			
Megane I (BA 0/1_) 1,9 dTi, Ø280,0 mm	03/97-	TRW	TP.A-099	18,0			
Megane I (BA 0/1_) 2,0i, -04/00	01/96-	TRW	TP.A-099	18,0			
Megane I (BA 0/1_) 2,0i, 03/99-04/00	01/96-	TRW	TP.A-099	18,0			
Megane I (BA 0/1_) 1,4e, -02/99	01/96-	TRW	TP.A-090	18,0			
Megane I (BA 0/1_) 1,6e	01/96-03/99	TRW	TP.A-090	18,0			
Megane I (BA 0/1_) 1,6i	01/96-03/99	TRW	TP.A-090	18,0			
Megane I (BA 0/1_) 1,9D	10/96-03/99	TRW	TP.A-090	18,0			
Megane I (BA 0/1_) 1,9D, Eco, -02/99	01/96-	TRW	TP.A-090	18,0			
Megane I (BA 0/1_) 1,9 dT, -05/99	01/96-	TRW	TP.A-090	18,0			
Megane I (BA 0/1_) 1,9 dTi, -01/00, Ø259,0 mm	03/97-	TRW	TP.A-090	18,0			
Megane I (BA 0/1_) 1,9 dTi, -01/00, Ø280,0 mm	03/97-	TRW	TP.A-090	18,0			
Megane I (BA 0/1_) 2,0i, -02/99, Ø259,0 mm	01/96-	TRW	TP.A-090	18,0			
Megane I (BA 0/1_) 2,0i, -02/99, Ø280,0 mm	01/96-	TRW	TP.A-090	18,0			
Megane I (BA 0/1_) 2,0i, -05/99, Ø259,0 mm	01/96-	TRW	TP.A-090	18,0			
Megane I (BA 0/1_) 2,0i, -05/99, Ø280,0 mm	01/96-	TRW	TP.A-090	18,0			
Megane I (BA 0/1_) 1,4 16V	03/99-	TRW	TP.A-090	18,0	BDX	TP.A-067	11,0
Megane I (BA 0/1_) 1,4e, 03/99-01/00	01/96-	TRW	TP.A-090	18,0			
Megane I (BA 0/1_) 1,4e, 02/00-	01/96-	TRW	TP.A-090	18,0			
Megane I (BA 0/1_) 1,6	02/00-09/00	TRW	TP.A-090	18,0			
Megane I (BA 0/1_) 1,6 16V, спорт. подвеска (+)	03/99-	TRW	TP.A-090	18,0			
Megane I (BA 0/1_) 1,9 D, -03/98	10/96-02/99	TRW	TP.A-090	18,0			
Megane I (BA 0/1_) 1,9 D, 04/98-01/00	10/96-01/00	TRW	TP.A-090	18,0			
Megane I (BA 0/1_) 1,9 D/Eco. 03/99-	01/96-	TRW	TP.A-090	18,0			
Megane I (BA 0/1_) 1,9 dTi, -08/02, Ø259,0 mm	03/97-	TRW	TP.A-090	18,0	BDX	TP.A-067	11,0
Megane I (BA 0/1_) 1,9 dTi, -08/02, Ø280,0 mm	03/97-	TRW	TP.A-090	18,0			
Megane I (BA 0/1_) 1,9 dTi, 10/98-08/99	03/97-	TRW	TP.A-090	18,0			
Megane I (BA 0/1_) 1,9 dTi, 09/99-01/00	03/97	TRW	TP.A-090	18,0			
Megane I (BA 0/1_) 1,9 dTi, Ø259,0 mm	03/97-	TRW	TP.A-090	18,0			
Megane I (BA 0/1_) 1,9 dTi, Ø280,0 mm	03/97-	TRW	TP.A-090	18,0			
Megane I (BA 0/1_) 1,9 DTI, -05/99	09/96-	TRW	TP.A-090	18,0			
Megane I Break 1,4 16V (KA0D, KA1H, KA0W, KA10)	03/99 – 08/03	TRW	TP.A-090	18,0			
Megane I Break 1,4 e (KA0V)	03/99 – 08/03	TRW	TP.A-090	18,0			

Марка автомобиля	Годы выпуска автомобиля	Передние колодки			Задние колодки		
		Тип тормозной системы	№ по каталогу	Толщина изделия, мм	Тип тормозной системы	№ по каталогу	Толщина изделия, мм
RENAULT							
Megane I Break 1,6 16V (KA0B, KA04, KA11)	03/99 – 08/03	BO TRW	TP.A-094 TP.A-099	18,3 18,0			
Megane I Break 1,6 e (KA0F)	03/99 – 08/03	TRW	TP.A-090	18,0			
Megane I Break 1,8 16V (KA0S, KA12, KA1A, KA1M, KA1R)	01/01 – 08/03	TRW	TP.A-099	18,0			
Megane I Break 1,9 D (KA0J, KA0R)	04/99 – 08/03	TRW	TP.A-090	18,0			
Megane I Break 1,9 dCi (KA05, KA1F)	02/01 – 08/03	TRW	TP.A-099	18,0			
Megane I Break 1,9 dTi (KA0N, KA1U)	03/99 – 08/03	TRW	TP.A-099	18,0			
Megane I Classic 1,4 (LA0E, LA0V)	09/96 – 08/03	TRW	TP.A-090	18,0			
Megane I Classic 1,4 16V (LA0D, LA1H, LA0W, LA10)	03/99 – 08/03	TRW	TP.A-099	18,0	BDX	TP.A-067	11,0
Megane I Classic 1,6i (LA0F, LA0S)	09/96 – 03/99	TRW	TP.A-090	18,0			
Megane I Classic 1,6 16V (LA04, LA11, LA0B, LA1C, LA1J)	03/99 – 08/03				BDX	TP.A-067	11,0
Megane I Classic 1,8 16V (LA06, LA12, LA1A, LA1M, LA1R)	01/01 – 08/03	TRW	TP.A-099	18,0	BDX	TP.A-067	11,0
Megane I Classic 1,9 dCi (LA05, LA1F)	02/01 – 08/03	TRW	TP.A-099	18,0	BDX	TP.A-067	11,0
Megane I Classic 1,9 dTi (LA08, LA0N)	03/97 – 02/01	TRW	TP.A-090 TP.A-099	18,0	BDX	TP.A-067	11,0
Megane I Classic 1,9 D / TDI (LA0A, LA0U)	09/96 – 08/03	TRW	TP.A-090	18,0			
Megane I Classic 1,9 dT (LA0K, LA0Y)	09/96 – 08/03	TRW	TP.A-090	18,0			
Megane I Classic 2,0i (LA0G)	03/99 – 08/03	TRW	TP.A-090 TP.A-099	18,0	BDX	TP.A-067	11,0
Megane I Convertible (EA 0/1_) 1,4 16V, 10/00-07/03	03/99-	TRW	TP.A-090	18,0	BDX	TP.A-067	11,0
Megane I Convertible (EA 0/1_) 1,4e	10/96-03/99	TRW	TP.A-099	18,0			
Megane I Convertible (EA 0/1_) 1,4 16V, -09/00	03/99-	TRW	TP.A-090	18,0			
Megane I Convertible (EA 0/1_) 1,6 16V	03/99-	TRW	TP.A-090	18,0	BDX	TP.A-067	11,0
Megane I Convertible (EA 0/1_) 2,0 16V, 02/97-01/99	10/96-	TRW	TP.A-099	18,0	BDX	TP.A-067	11,0
Megane I Convertible (EA 0/1_) 2,0 16V IDE, -07/03	11/99	TRW	TP.A-099	18,0			
Megane I Convertible (EA 0/1_) 2,0i, 10/99-07/03	03/99-	TRW	TP.A-099	18,0	BDX	TP.A-067	11,0
Megane I Convertible (EA 0/1_) 2,0, -02/99	04/97-	TRW	TP.A-090	18,0			
Megane I Convertible (EA 0/1_) 2,0 16V, 08/03-	10/96-	BO	TP.A-094	18,3	BDX	TP.A-067	11,0
Megane I Coupe (DA 0/1_) 1,4 16V, 10/00-07/03	03/99-08/03	TRW	TP.A-099	18,0	BDX	TP.A-067	11,0
Megane I Coupe (DA 0/1_) 1,4 16V, -09/00	03/99-08/03	TRW	TP.A-090	18,0	BDX	TP.A-067	11,0
Megane I Coupe (DA 0/1_) 1,6 16V, -07/03	03/99-08/03	TRW	TP.A-099	18,0	BDX	TP.A-067	11,0

Марка автомобиля	Годы выпуска автомобиля	Передние колодки			Задние колодки		
		Тип тормозной системы	№ по каталогу	Толщина изделия, мм	Тип тормозной системы	№ по каталогу	Толщина изделия, мм
RENAULT							
Megane I Coupe (DA 0/1_) 1,6e	03/96-03/99	TRW	TP.A-090	18,0			
Megane I Coupe (DA 0/1_) 1,9 DCi	03/99-08/03	TRW	TP.A-099	18,0	BDX	TP.A-067	11,0
Megane I Coupe (DA 0/1_) 1,9 dTi, 06/99-09/00	03/97-02/01	TRW	TP.A-099	18,0			
Megane I Coupe (DA 0/1_) 2,0 16V, -07/03	03/96-08/03	TRW	TP.A-099	18,0	BDX	TP.A-067	11,0
Megane I Coupe (DA 0/1_) 2,0 16V IDE, -07/03	11/99-08/03	TRW	TP.A-099	18,0	BDX	TP.A-067	11,0
Megane I Coupe (DA 0/1_) 2,0i, 06/99-	03/96-08/03	TRW	TP.A-099	18,0	BDX	TP.A-067	11,0
Megane I Coupe (DA 0/1_) 2,0i, -02/99, Ø280,0 mm	03/96-08/03	TRW	TP.A-090	18,0	BDX	TP.A-067	11,0
Megane I Coupe (DA 0/1_) 2,0i, Ø259,0 mm	03/96-08/03	TRW	TP.A-090	18,0			
Megane I Estate (KA 0/1_) 1,4 16V, 10/00-	03/99-	TRW	TP.A-090	18,0			
Megane I Estate (KA 0/1_) 1,4 16V, -09/00	03/99-	TRW	TP.A-090	18,0			
Megane I Estate (KA 0/1_) 1,4e, -09/00	02/99	TRW	TP.A-090	18,0			
Megane I Estate (KA 0/1_) 1,6 16V, -10/05	03/99-	BO	TP.A-094	18,3			
Megane I Estate (KA 0/1_) 1,6e, -01/00	03/99-	TRW	TP.A-090	18,0			
Megane I Estate (KA 0/1_) 1,6 16V	03/99-	TRW	TP.A-090	18,0			
Megane I Estate (KA 0/1_) 1,6 16V, -07/03	03/99-	TRW	TP.A-099	18,0			
Megane I Estate (KA 0/1_) 1,8 16V	01/01-	TRW	TP.A-099	18,0			
Megane I Estate (KA 0/1_) 1,9 dCi, -07/03	02/01-	TRW	TP.A-099	18,0			
Megane I Estate (KA 0/1_) 1,9 dTi	03/99-	TRW	TP.A-099	18,0			
Megane I Estate (KA 0/1_) 1,9 dTi	03/97-	TRW	TP.A-090	18,0			
Megane I Estate (KA 0/1_) 1,9 D, -09/00	03/99-	TRW	TP.A-090	18,0			
Megane I Grandtour 1,4 16V (KA0D, KA1H, KA0W, KA10)	03/99 – 08/03	TRW	TP.A-090	18,0			
Megane I Grandtour 1,4 e (KA0V)	03/99 – 08/03	TRW	TP.A-090	18,0			
Megane I Grandtour 1,6 16V (KA0B, KA04, KA11)	03/99 – 08/03	BO TRW	TP.A-094 TP.A-099	18,3 18,0			
Megane I Grandtour 1,6 e (KA0F)	03/99 – 08/03	TRW	TP.A-090	18,0			
Megane I Grandtour 1,8 16V (KA0S, KA12, KA1A, KA1M, KA1R)	01/01 – 08/03	TRW	TP.A-099	18,0			
Megane I Grandtour 1,9 D (KA0J, KA0R)	04/99 – 08/03	TRW	TP.A-090	18,0			
Megane I Grandtour 1,9 dCi (KA05, KA1F)	02/01 – 08/03	TRW	TP.A-099	18,0			
Megane I Grandtour 1,9 dTi (KA0N, KA1U)	03/99 – 08/03	TRW	TP.A-099	18,0	BDX	TP.A-067	11,0
Megane I Saloon (LA 0/1_) 1,4, Ø238,0 mm	09/96-	TRW	TP.A-090	18,0			
Megane I Saloon (LA 0/1_) 1,4, Ø259,0 mm	09/96-	TRW	TP.A-090	18,0			
Megane I Saloon (LA 0/1_) 1,4 16V	03/99-	TRW	TP.A-099	18,0			
Megane I Saloon (LA 0/1_) 1,6 16V, -09/00, Ø259,0 mm	03/99-	TRW	TP.A-090	18,0			

Марка автомобиля	Годы выпуска автомобиля	Передние колодки			Задние колодки		
		Тип тормозной системы	№ по каталогу	Толщина изделия, мм	Тип тормозной системы	№ по каталогу	Толщина изделия, мм
RENAULT							
Megane I Saloon (LA 0/1_) 1,6 16V, -09/00, Ø280,0 mm	03/99-	TRW	TP.A-090	18,0			
Megane I Saloon (LA 0/1_) 1,6e	09/96-03/99	TRW	TP.A-090	18,0			
Megane I Saloon (LA 0/1_) 1,6i	09/96-03/99	TRW	TP.A-090	18,0			
Megane I Saloon (LA 0/1_) 1,6 16V, -07/03	03/99	TRW	TP.A-099	18,0			
Megane I Saloon (LA 0/1_) 1,8 16V, -07/03	01/01-	TRW	TP.A-099	18,0			
Megane I Saloon (LA 0/1_) 1,9 dCi, -07/03	02/01-	TRW	TP.A-099	18,0			
Megane I Saloon (LA 0/1_) 1,9 dTi, 03/99-09/00	03/97	TRW	TP.A-099	18,0			
Megane I Saloon (LA 0/1_) 1,9 D, -02/99	09/96-	TRW	TP.A-090	18,0			
Megane I Saloon (LA 0/1_) 1,9 dT, -02/99	09/96-	TRW	TP.A-090	18,0			
Megane I Saloon (LA 0/1_) 1,9 dTi, -02/99, Ø259,0 mm	03/97-	TRW	TP.A-090	18,0			
Megane I Saloon (LA 0/1_) 1,9 dTi, -02/99, Ø280,0 mm	03/97-	TRW	TP.A-090	18,0			
Megane I Saloon (LA 0/1_) 1,9 DTI, -02/99	09/96-	TRW	TP.A-090	18,0			
Megane I Saloon (LA 0/1_) 1,9 D, 03/99-	09/96-	TRW	TP.A-090	18,0			
Megane I Saloon (LA 0/1_) 2,0i, -02/99	09/96-	TRW	TP.A-090	18,0			
Megane I Saloon (LA 0/1_) 2,0i, -08/00	09/96-	TRW	TP.A-099	18,0			
Megane II (BM 0/1_, CM 0/1_) 1,5 dCi	11/02-	BO	TP.A-094	18,3			
Megane II (BM 0/1_, CM 0/1_) 1,5 dCi, -10/05	11/02-	BO	TP.A-094	18,3			
Megane II (BM 0/1_, CM 0/1_) 1,6, -10/05	06/05-	BO	TP.A-094	18,3			
Megane II (BM 0/1_, CM 0/1_) 1,6 16V, -10/05	11/02-	BO	TP.A-094	18,3			
Megane II (BM 0/1_, CM 0/1_) 1,9 dCi, -10/05	11/02	BO	TP.A-094	18,3			
Megane II (BM 0/1_, CM 0/1_) 2,0 16V, -07/03	11/02-	BO	TP.A-094	18,3			
Megane II (BM 0/1_, CM 0/1_) 2,0 16V, 08/03-10/05	11/02-	BO	TP.A-094	18,3			
Megane II (BM 0/1_, CM 0/1_) 2,0 16V Turbo, -10/05	05/04-	BO	TP.A-094	18,3			
Megane II Estate (KM0/1_) 1,4	08/03 –	BO	TP.A-094	18,3			
Megane II Estate (KM0/1_) 1,5 dCi (KM16, KM1E)	08/03 –	BO	TP.A-094	18,3			
Megane II Estate (KM0/1_) 1,6	08/03 –	BO	TP.A-094	18,3			
Megane II Estate (KM0/1_) 1,6 16V	01/06 –	BO	TP.A-094	18,3			
Megane II Estate (KM0/1_) 1,9 dCi	08/03 –	BO	TP.A-094	18,3			
Megane II Estate (KM0/1_) 2,0	08/03 –	BO	TP.A-094	18,3			
Megane II Convertible (EM 0/1_) 1,5 dCi, -10/05	05/05-	BO	TP.A-094	18,3			

Марка автомобиля	Годы выпуска автомобиля	Передние колодки			Задние колодки		
		Тип тормозной системы	№ по каталогу	Толщина изделия, мм	Тип тормозной системы	№ по каталогу	Толщина изделия, мм
RENAULT							
Megane II Convertible (EM 0/1_) 1,5 dCi	05/05-	BO	TP.A-094	18,3			
Megane II Convertible (EM 0/1_) 1,6	09/03-	BO	TP.A-094	18,3			
Megane II Convertible (EM 0/1_) 1,6 16V	01/07-	BO	TP.A-094	18,3			
Megane II Convertible (EM 0/1_) 1,9 dCi	09/03-	BO	TP.A-094	18,3			
Megane II Convertible (EM 0/1_) 2,0	09/03-	BO	TP.A-094	18,3			
Megane II Convertible (EM 0/1_) 2,0 16V Turbo	05/04-	BO	TP.A-094	18,3			
Megane II Grandtour (LM 0/1_) 1,4, -10/05	08/03-	BO	TP.A-094	18,3			
Megane II Grandtour (LM 0/1_) 1,5 dCi, -10/05	08/03-	BO	TP.A-094	18,3			
Megane II Grandtour (LM 0/1_) 1,6, -10/05	08/03-	BO	TP.A-094	18,3			
Megane II Grandtour (LM 0/1_) 1,6 16V	01/07-	BO	TP.A-094	18,3			
Megane II Grandtour (LM 0/1_) 1,9 dCi, -10/05	08/03-	BO	TP.A-094	18,3			
Megane II Grandtour (LM 0/1_) 2,0, -10/05	08/03-	BO	TP.A-094	18,3			
Megane II Sport Tourer (KM0/1_) 1,4	08/03 –	BO	TP.A-094	18,3			
Megane II Sport Tourer (KM0/1_) 1,5 dCi	08/03 –	BO	TP.A-094	18,3			
Megane II Sport Tourer (KM0/1_) 1,6	08/03 –	BO	TP.A-094	18,3			
Megane II Sport Tourer (KM0/1_) 1,6 16V	01/06 –	BO	TP.A-094	18,3			
Megane II Sport Tourer (KM0/1_) 1,9 dCi	08/03 –	BO	TP.A-094	18,3			
Megane II Sport Tourer (KM0/1_) 2,0	08/03 –	BO	TP.A-094	18,3			
Megane II Saloon (LM 0/1_) 1,4	09/03-	BO	TP.A-094	18,3			
Megane II Saloon (LM 0/1_) 1,5 dCi	09/03-	BO	TP.A-094	18,3			
Megane II Saloon (LM 0/1_) 1,5 dCi, -10/05	09/03-	BO	TP.A-094	18,3			
Megane II Saloon (LM 0/1_) 1,6	09/03-	BO	TP.A-094	18,3			
Megane II Saloon (LM 0/1_) 1,6, -10/05	09/03-	BO	TP.A-094	18,3			
Megane II Saloon (LM 0/1_) 1,6 16V	01/07-	BO	TP.A-094	18,3			
Megane II Saloon (LM 0/1_) 1,9 dCi	09/03-	BO	TP.A-094	18,3			
Megane II Saloon (LM 0/1_) 2,0, -10/05	09/03-	BO	TP.A-094	18,3			
Megane III Saloon 1,6 16V	06/09-						
Megane III Saloon 1,9 dCi	06/09-						
Megane MPV (JA 0/1_) 1,4i	01/97-09/99	TRW	TP.A-090	18,0			
Megane MPV (JA 0/1_) 1,6e, MTM	01/97-09/99	TRW	TP.A-090	18,0			
Megane MPV (JA 0/1_) 1,6i, MTM	01/97-09/99	TRW	TP.A-090	18,0			
Megane MPV (JA 0/1_) 1,6e, MTM	01/97-09/99	TRW	TP.A-099	18,0			
Megane MPV (JA 0/1_) 1,6i, MTM	01/97-09/99	TRW	TP.A-099	18,0			
Megane MPV (JA 0/1_) 1,9 D	03/97-09/99	TRW	TP.A-099	18,0			
Megane MPV (JA 0/1_) 2,0i, 03/99-, Ø259,0 mm	01/97-09/99	TRW	TP.A-099	18,0			

Марка автомобиля	Годы выпуска автомобиля	Передние колодки			Задние колодки		
		Тип тормозной системы	№ по каталогу	Толщина изделия, мм	Тип тормозной системы	№ по каталогу	Толщина изделия, мм
RENAULT							
Megane MPV (JA 0/1_) 2,0i, 03/99-, Ø262,0 mm	01/97-09/99	TRW	TP.A-099	18,0			
Megane MPV (JA 0/1_) 2,0i, 03/99-, Ø280,0 mm	01/97-09/99	TRW	TP.A-099	18,0			
Megane MPV (JA 0/1_) 2,0i, Ø259,0 mm	01/97-09/99	TRW	TP.A-099	18,0			
Megane MPV (JA 0/1_) 2,0i, Ø262,0 mm	01/97-09/99	TRW	TP.A-099	18,0			
Megane MPV (JA 0/1_) 2,0i, Ø280,0 mm	01/97-09/99	TRW	TP.A-099	18,0			
Megane MPV (JA 0/1_) 2,0i, -02/99, Ø259,0 mm	01/97-09/99	TRW	TP.A-099	18,0			
Megane MPV (JA 0/1_) 2,0i, -02/99, Ø262,0 mm	01/97-09/99	TRW	TP.A-099	18,0			
Megane MPV (JA 0/1_) 2,0i, -02/99, Ø280,0 mm	01/97-09/99	TRW	TP.A-099	18,0			
Megane MPV (JA 0/1_) 2,0i, -05/99, Ø259,0 mm	01/97-09/99	TRW	TP.A-099	18,0			
Megane MPV (JA 0/1_) 2,0i, -05/99, Ø262,0 mm	01/97-09/99	TRW	TP.A-099	18,0			
Megane MPV (JA 0/1_) 2,0i, -05/99, Ø280,0 mm	01/97-09/99	TRW	TP.A-099	18,0			
R4 1,0	86-93	BDX	TP.A-033	14,0			
R4 1,1 TL, GTL	78-82	BDX	TP.A-033	14,0			
R4 1,1 GTL	82-88	BDX	TP.A-033	14,0			
R4 1,1 Fourgonette F4, F6	82-90	BDX	TP.A-033	14,0			
R4 1,1 Pick Up	79-86	BDX	TP.A-033	14,0			
R4 1,1 Societe	89-93	BDX	TP.A-033	14,0			
R4 Transporter 0,8 F4	76-86	BDX	TP.A-033	14,0			
R4 Transporter 1,1 F6	76-86	BDX	TP.A-033	14,0			
R5 1,0 C	85-86	BDX	TP.A-067	15,0			
R5 1,1	90-91	BDX	TP.A-067	15,0			
R5 1,1 TL	84-86	BDX	TP.A-067	15,0			
R5 1,1 L, TL, SL	86-89	BDX	TP.A-067	15,0			
R5 1,2	87-91	BDX	TP.A-011	18,0			
R5 1,4 GTL, GTR	85-91	BDX	TP.A-011	18,0			
R5 1,4 GTS, TSE, TS	84-87	BDX	TP.A-011	18,0			
R5 1,4i	85-91	BDX	TP.A-011	18,0			
R5 1,6 Diesel TD, SD, GTD	86-	BDX	TP.A-011	18,0			
R5 1,7 GTX	87-90	BDX	TP.A-011	18,0	BDX	TP.A-067	11,0
R5-Le Car 0,8L	80-85	BDX	TP.A-033	14,0			
R5-Le Car 0,8 Societe	77-84	BDX	TP.A-033	14,0			
R5-Le Car 0,9 TL, GTL	72-82	BDX	TP.A-033	14,0			
R5-Le Car 0,9 L	84-85	BDX	TP.A-033	14,0			
R5-Le Car 1,1 TL, GTL	81-85	BDX	TP.A-033	14,0			
R5-Le Car 1,1 TL, GTL, Societe	79-84	BDX	TP.A-033	14,0			
R5-Le Car 1,3	72-81	BDX	TP.A-033	14,0			
R5-Le Car 1,3 GTL	72-83	BDX	TP.A-033	14,0			
R5-Le Car 1,3 TS	72-83	BDX	TP.A-033	14,0			
R5-Le Car 1,3 Societe	72-83	BDX	TP.A-033	14,0			
R5-Le Car 1,4	84-85	BDX	TP.A-033	14,0			

Марка автомобиля	Годы выпуска автомобиля	Передние колодки			Задние колодки		
		Тип тормозной системы	№ по каталогу	Толщина изделия, мм	Тип тормозной системы	№ по каталогу	Толщина изделия, мм
RENAULT							
R5-Le Car 1,4 Turbo	84-85	BDX	TP.A-033	14,0	BDX	TP.A-033	14,0
R5-Le Car 1,4 TS, TX	81-85	BDX	TP.A-033	14,0			
R5-Le Car 1,4 Alpine	72-83	BDX	TP.A-033	14,0			
R5-Le Car 1,4 Alpine Turbo	82-85	BDX	TP.A-033	14,0	BDX	TP.A-033	14,0
R5-Le Car 1,4 Gordini	79-81	BDX	TP.A-033	14,0			
R5-Le Car 1,4 Gordini Turbo	81-85	BDX	TP.A-033	14,0	BDX	TP.A-033	14,0
R5 Van 1,0	85-90	BDX	TP.A-011	18,0			
R5 Van 1,1	85-	BDX	TP.A-011	18,0			
R5 Van 1,2	85-90	BDX	TP.A-011	18,0			
R5 Van 1,6 D	86-	BDX	TP.A-011	18,0			
R6 1,1 TL	72-80	BDX	TP.A-033	14,0			
R9 1,1 C, TC, GTC	81-86	BDX	TP.A-011	18,0			
R9 1,1 TC	86-87	BDX	TP.A-011	18,0			
R9 1,4	81-89	BDX	TP.A-011	18,0			
R9 1,4 Automatic	81-88	BDX	TP.A-011	18,0			
R9 1,4 TL, GTL, TLE	81-89	BDX	TP.A-011	18,0			
R9 1,4 TC, GTS, TSE	81-84	BDX	TP.A-011	18,0			
R9 1,4 GTL	85-89	BDX	TP.A-011	18,0			
R9 1,4 Turbo	86-89	BDX	TP.A-011	18,0	BDX	TP.A-067	11,0
R9 1,7 TX, GTX	87-88	BDX	TP.A-011	18,0			
R9 1,7 TX	85-87	BDX	TP.A-011	18,0			
R9 1,7 TXE	86-87	BDX	TP.A-011	18,0			
R9 1,7 TX, GTE	86-88	BDX	TP.A-011	18,0			
R9 1,6 Diesel TD, GTD	83-89	BDX	TP.A-011	18,0			
R11 1,6 Diesel TD, GTD	83-89	BDX	TP.A-011	18,0			
R11 1,6 Diesel Societe	83-89	BDX	TP.A-011	18,0			
R12 1,3 Break (Sedan, Variable)	75-80	BDX	TP.A-033	14,0			
R12 1,3 L, TL, TS, TR	75-80	BDX	TP.A-033	14,0			
R14 1,2 L, TL, GTL	76-83	BDX	TP.A-033	15,0			
R14 1,2 L, TL, GTL	76-83	ATE	TP.A-033	14,0			
R14 1,4 GTL	81-83	BDX	TP.A-033	15,0			
R14 1,4 GTL	81-83	ATE	TP.A-033	14,0			
R14 1,4 LS, TS	79-83	BDX	TP.A-033	15,0			
R14 1,4 LS, TS	79-83	ATE	TP.A-033	14,0			
R15 Coupe 1,3 TL, GTL	72-79	BDX	TP.A-033	14,0			
R15 Coupe 1,5 GTL	72-76	BDX	TP.A-033	14,0			
R16 1,6 TL, TL Automatic, TX	76-80	BDX	TP.A-033	14,0			
R17 1,6 Coupe	76-79	BDX	TP.A-033	14,0			
R18 1,4 TL, GTL	78-82	BDX	TP.A-033	14,0			
R18 1,4 TL, GTL	82-83	BDX	TP.A-011	18,0			
R18 1,4 Societe	81-84	BDX	TP.A-033	14,0			
R18 1,4 Societe	84-86	BDX	TP.A-011	18,0			

Марка автомобиля	Годы выпуска автомобиля	Передние колодки			Задние колодки		
		Тип тормозной системы	№ по каталогу	Толщина изделия, мм	Тип тормозной системы	№ по каталогу	Толщина изделия, мм
RENAULT							
R18 1,6 TS, GTS	78-83	BDX	TP.A-033	14,0			
R18 1,6 TS, GTS	78-83	BDX	TP.A-011	18,0			
R18 1,6 Turbo	82-85	BDX	TP.A-011	18,0	BDX	TP.A-033	14,0
R18 2,0 TX, GTX	82-83	BDX	TP.A-011	18,0			
R18 2,0	83-85	BDX	TP.A-011	18,0			
R18 2,1 Diesel TD, GTD	80-86	BDX	TP.A-011	18,0			
R18 2,1 Diesel Societe	81-86	BDX	TP.A-011	18,0			
R18 2,1 Turbodiesel	84-86	BDX	TP.A-011	18,0			
R18 Kombi 1,4 TL	79-82	BDX	TP.A-033	14,0			
R18 Kombi 1,4 TL	82-86	BDX	TP.A-011	18,0			
R18 Kombi 1,6	82-86	BDX	TP.A-011	18,0			
R18 Kombi 1,6 GTL, TS	79-82	BDX	TP.A-033	14,0			
R18 Kombi 1,6 GTL, TS	82-86	BDX	TP.A-011	18,0			
R18 Kombi 1,6 GTL 4 WD	84-85	BDX	TP.A-011	18,0			
R18 Kombi 2,0 GTX, TX	82-85	BDX	TP.A-011	18,0			
R18 Kombi 2,1 Diesel GTD 4WD	84-86	BDX	TP.A-011	18,0			
R18 Kombi 2,1 Diesel TD, GTD	80-86	BDX	TP.A-011	18,0			
R18 Kombi 2,1 Turbodiesel	85-86	BDX	TP.A-011	18,0			
R 19 1,2 TR Societe	88-92	BDX	TP.A-011	18,0			
R 19 1,4 GTR, GTS, TR, TRE, TSE	88-92	BDX	TP.A-011	18,0			
R 19 1,4 Societe	89-92	BDX	TP.A-011	18,0			
R 19 1,4 1,4i	88-92	BDX	TP.A-011	18,0			
R 19 1,7 GTX, GTS, TXE, TSE, TXi	88-92	BDX	TP.A-011	18,0	BDX	TP.A-067	11,0
R 19 1,8 16V	89-92				BDX	TP.A-067	11,0
R 19 1,9 D TD, GTD, TDE	88-92	BDX	TP.A-011	18,0			
R 19 1,9 D Societe	88-92	BDX	TP.A-011	18,0			
R 19 (X 53) 1,2	92-	BDX	TP.A-011	18,0			
R 19 (X 53) 1,2 Societe	92-	BDX	TP.A-011	18,0			
R 19 (X 53) 1,4	92-	BDX	TP.A-011	18,0			
R 19 (X 53) 1,4 RL, RN	92-94	BDX	TP.A-011	18,0			
R 19 (X 53) 1,4i	92-94	BDX	TP.A-011	18,0			
R 19 (X 53) 1,4e Societe	92-	BDX	TP.A-011	18,0			
R 19 (X 53) 1,7	92-				BDX	TP.A-067	11,0
R 19 (X 53) 1,7i	92-	BDX	TP.A-011	18,0	BDX	TP.A-067	11,0
R 19 (X 53) 1,8 RN, RT	92-				BDX	TP.A-067	11,0
R 19 (X 53) 1,8s RT	92-				BDX	TP.A-067	11,0
R 19 (X 53) 1,8i RT	92-				BDX	TP.A-067	11,0
R 19 (X 53) 1,8	94-				BDX	TP.A-067	11,0
R 19 (X 53) 1,9 D, RL, RN, RT	92-	BDX	TP.A-011	18,0	BDX	TP.A-067	11,0
R 19 (X 53) 1,9 D Societe	92-	BDX	TP.A-011	18,0			
R 19 (X 53) 1,9 dT, RN, RT	92-				BDX	TP.A-067	11,0
R 19 Cabrio 1,7	91-92				BDX	TP.A-067	11,0
R 19 Cabrio 1,8	92-				BDX	TP.A-067	11,0
R 19 Cabrio 1,8 16 V	92				BDX	TP.A-067	11,0
R 19 Chamade 1,2	89-90	BDX	TP.A-011	18,0			

Марка автомобиля	Годы выпуска автомобиля	Передние колодки			Задние колодки		
		Тип тормозной системы	№ по каталогу	Толщина изделия, мм	Тип тормозной системы	№ по каталогу	Толщина изделия, мм
RENAULT							
R 19 Chamade 1,4	90-92	BDX	TP.A-011	18,0			
R 19 Chamade 1,4 GTS	90-92	BDX	TP.A-011	18,0			
R 19 Chamade 1,4i	88-92	BDX	TP.A-011	18,0			
R 19 Chamade 1,7 GTS, GTX, TSE, TXE	90-92	BDX	TP.A-011	18,0			
R 19 1,9 D GTD, TDE	90-92	BDX	TP.A-011	18,0			
R 20 1,6 L, TL, GTL	77-80	BDX	TP.A-033	14,0			
R 20 1,6 L, TL, GTL	80-81	BDX	TP.A-011	18,0			
R 20 2,0 LS, TS	80-83	BDX	TP.A-011	18,0			
R 20 2,1 Diesel TD, GTD	80-84	BDX	TP.A-011	18,0			
R 21 1,4	88-92	BDX	TP.A-011	18,0			
R 21 1,7 TL, GTL	89-91	BDX	TP.A-011	18,0			
R 21 1,7 TL, RS, GTS	86-89	BDX	TP.A-011	18,0			
R 21 1,7 GTS	87-89	BDX	TP.A-011	18,0			
R 21 1,7 GTS, TSE	89-92	BDX	TP.A-011	18,0			
R 21 1,7 Societe	87-93	BDX	TP.A-011	18,0			
R 21 2,0 RX, TXE, GTX	86-89				BDX	TP.A-033	14,0
R 21 2,0 TXE	91-94				BDX	TP.A-033	14,0
R 21 2,0 TXi	89-92				BDX	TP.A-033	14,0
R 21 2,0 Turbo 4 WD	90-92				BDX	TP.A-033	14,0
R 21 2,0 Turbo	87-89				BDX	TP.A-033	14,0
R 21 2,0 Quadra 12 V	90-92				BDX	TP.A-033	14,0
R 21 2,0 Quadra 12 V Cat	90-94				BDX	TP.A-033	14,0
R 21 2,0 Quadra Turbo	88-94				BDX	TP.A-033	14,0
R 21 2,2 RX, TXE, GTX	86-94				BDX	TP.A-033	14,0
R 21 2,2 TXE, 4 WD	90-94				BDX	TP.A-033	14,0
R 21 2,2 I Quadra Cat	90-93				BDX	TP.A-033	14,0
R 21 1,9 D Societe	89-90	BDX	TP.A-011	18,0			
R 21 2,1 Turbodiesel	86-93				BDX	TP.A-033	14,0
R 21 Nevada Kombi 1,7 GTS	86-89	BDX	TP.A-011	18,0			
R 21 Nevada Kombi 2,0 GTX	87-89				BDX	TP.A-033	14,0
R 21 Nevada Kombi 2,0 TXi, RTi	91-95				BDX	TP.A-033	14,0
R 21 Nevada Kombi 2,2 GTX, RT, TXE Cat	88-92				BDX	TP.A-033	14,0
R 21 Nevada Kombi 1,9 D	89-	BDX	TP.A-011	18,0			
R 21 Nevada Kombi 2,1 Diesel	92-				BDX	TP.A-033	14,0
R 21 Nevada Kombi 2,1 Turbodiesel RT	87-92				BDX	TP.A-019	19,5
R 25 2,0	88-92				BDX	TP.A-033	14,0
R 25 2,0 TS, GTS	84-92				BDX	TP.A-033	14,0
R 25 2,0 TX	87-92				BDX	TP.A-033	14,0
R 25 2,2 GTX	84-92				BDX	TP.A-033	14,0
R 25 2,5 V 6 Turbo	85-88				BDX	TP.A-033	14,0
R 25 2,6 V 6i	84-92				BDX	TP.A-033	14,0
R 25 2,8 V 6 Injection	86-92				BDX	TP.A-033	14,0
R 25 2,8 V 6 TX	87-92				BDX	TP.A-033	14,0
R 25 2,1 Diesel GTD	84-92				BDX	TP.A-033	14,0
R 25 2,1 Turbodiesel, DX	84-92				BDX	TP.A-033	14,0

Марка автомобиля	Годы выпуска автомобиля	Передние колодки			Задние колодки		
		Тип тормозной системы	№ по каталогу	Толщина изделия, мм	Тип тормозной системы	№ по каталогу	Толщина изделия, мм
RENAULT							
R 30 2,6 TS	76-81				BDX	TP.A-033	14,0
R 30 2,6 TX	79-84				BDX	TP.A-033	14,0
Rapid 1,0 Transporter	86-87	BDX	TP.A-011	18,0			
Rapid 1,0 Kombi	86-87	BDX	TP.A-011	18,0			
Rapid 1,1 Transporter	86-89	BDX	TP.A-011	18,0			
Rapid 1,1 Transporter	86-89	BDX	TP.A-067	15,0			
Rapid 1,1 Kombi	86-89	BDX	TP.A-011	18,0			
Rapid 1,1 Kombi	86-89	BDX	TP.A-067	15,0			
Rapid 1,1 Transporter	87-92	BDX	TP.A-011	18,0			
Rapid 1,1 Kombi	87-92	BDX	TP.A-011	18,0			
Rapid 1,1 Kombi, Kombi RN	92-	BDX	TP.A-011	18,0			
Rapid 1,2	96-	BDX	TP.A-011	18,0			
Rapid 1,2 (Cat)	91-	BDX	TP.A-011	18,0			
Rapid 1,4 Transporter	86-92	BDX	TP.A-011	18,0			
Rapid 1,4 Kombi	86-92	BDX	TP.A-011	18,0			
Rapid 1,4i Kombi (Cat)	86-92	BDX	TP.A-011	18,0			
Rapid 1,4 Kombi	91-	BDX	TP.A-011	18,0			
Rapid 1,4 Transporter	91-	BDX	TP.A-011	18,0			
Rapid 1,6 Kombi Diesel	86-92	BDX	TP.A-011	18,0			
Rapid 1,6 Transporter Diesel	86-92	BDX	TP.A-011	18,0			
Rapid 1,6 Transporter Diesel	91-	BDX	TP.A-011	18,0			
Rapid 1,9 Transporter Diesel	91-	BDX	TP.A-011	18,0			
Rapid 1,9 Kombi Diesel	91-	BDX	TP.A-011	18,0			
Rapid Box 1,0 (F40_, G40_)	09/85 – 05/92	BDX	TP.A-011 TP.A-067	18,0 15,0			
Rapid Box (F40-, G40-), (07-85-11/98), 1,1	07/85-04/95	TRW	TP.A-090	18,0			
Rapid Box (F40-, G40-), (07-85-11/98), 1,2	09/91-11/98	TRW	TP.A-090	18,0			
Rapid Box (F40-, G40-), (07-85-11/98), 1,2	-12/95	TRW	TP.A-090	18,0			
Rapid Box (F40-, G40-), (07-85-11/98), 1,4	07/85-03/98	TRW	TP.A-090	18,0			
Rapid Box (F40-, G40-), (07-85-11/98), 1,4	-05/95	TRW	TP.A-090	18,0			
Rapid Box (F40-, G40-), (07-85-11/98), 1,4	-08/97	TRW	TP.A-090	18,0			
Rapid Box (F40-, G40-), (07-85-11/98), 1,9	05/95-	TRW	TP.A-090	18,0			
Rapid Box (F40-, G40-), (07-85-11/98), 1,6D	03/86-08/98	TRW	TP.A-090	18,0			
Rapid Box (F40-, G40-), (07-85-11/98), 1,6D	10/86-	TRW	TP.A-090	18,0			
Rapid Box (F40-, G40-), (07-85-11/98), 1,9D	09/91-03/98	TRW	TP.A-090	18,0			
Rapid Box (F40-, G40-), (07-85-11/98), 1,9D	-05/95	TRW	TP.A-090	18,0			
Rodeo 5 1,1	81-87	BDX	TP.A-033	14,0			

Марка автомобиля	Годы выпуска автомобиля	Передние колодки			Задние колодки		
		Тип тормозной системы	№ по каталогу	Толщина изделия, мм	Тип тормозной системы	№ по каталогу	Толщина изделия, мм
RENAULT							
Safrane 3,0i V 6 Quadra	92-96				BDX	TP.A-067	15,0
Safrane 3,0 Biturbo	92-96				BDX	TP.A-067	15,0
Safrane II (B54-) (07/96-12/00), 2,0, 16V	03/99-04/00	TRW	TP.A-099	18,0			
Safrane II (B54-) (07/96-12/00), 2,2dT	03/99-	TRW	TP.A-099	18,0			
Safrane II (B54-) (07/96-12/00), 2,5, 20V	03/99-04/00	TRW	TP.A-099	18,0			
Safrane II (B54-) (07/96-12/00), 2,9, 24V	-04/00	TRW	TP.A-099	18,0			
Safrane II (B54-) (07/96-12/00), 3,0, 16V	03/99-04/00	TRW	TP.A-099	18,0			
Scenic I (JA 0/1-) (09/99008/03), 1,4, 16V	09/99-08/03	TRW	TP.A-099	18,0			
Scenic I (JA 0/1-) (09/99-08/03), 1,6	03/01-08/03	TRW	TP.A-099	18,0			
Scenic I (JA 0/1-) (09/99-08/03), 1,6, 16V	09/99-08/03	TRW	TP.A-099	18,0			
Scenic I (JA 0/1-) (09/99-08/03), 1,8, 16V	01/01-08/03	TRW	TP.A-099	18,0			
Scenic I (JA 0/1-) (09/99-08/03), 1,8, 4x4	07/00-04/01	TRW	TP.A-099	18,0			
Scenic I (JA 0/1-) (09/99-08/03), 1,9dCi	09/99-08/03	TRW	TP.A-099	18,0			
Scenic I (JA 0/1-) (09/99-08/03), 1,9dCi, RX4	11/00-08/03	TRW	TP.A-099	18,0			
Scenic I (JA 0/1-) (09/99-08/03), 1,9dTi	09/99-08/03	TRW	TP.A-099	18,0			
Scenic I (JA 0/1-) (09/99-08/03), 2,0 16V	07/00-08/03	TRW	TP.A-099	18,0			
Scenic I (JA 0/1-) (09/99-08/03), 16V IDE	09/99-08/03	TRW	TP.A-099	18,0			
Scenic II (JM 0/1-) (06/03-), 1,4	-10/05	BO	TP.A-094	18,3			
Scenic II (JM 0/1-) (06/03-), 1,5 dCi, Ø280 mm	-10/05	BO	TP.A-094	18,3			
Scenic II (JM 0/1-) (06/03-), 1,5 dCi, Ø300 mm	-10/05	BO	TP.A-094	18,3			
Scenic II (JM 0/1-) (06/03-), 1,6	-10/05	BO	TP.A-094	18,3			
Scenic II (JM 0/1-) (06/03-), 1,9 dCi	-08/05	BO	TP.A-094	18,3			
Scenic II (JM 0/1-) (06/03-), 1,9	-10/05	BO	TP.A-094	18,3			
Scenic II (JM 0/1-) (06/03-), 2,0	-10/05	BO	TP.A-094	18,3			
Scenic II (JM 0/1-) (05/04-), 16V Turbo	-10/05	BO	TP.A-094	18,3			
Sandero (11/07-) 1,4, ABS(+)	02/09-	TRW	TP.A-090	18,0			
Sandero (11/07-) 1,4, ABS(-)	02/09-	TRW	TP.A-090	18,0			
Sandero (11/07-) 1,6, ABS(+)	02/09-	TRW	TP.A-090	18,0			
Sandero (11/07-) 1,6, ABS(-)	02/09-	TRW	TP.A-090	18,0			
Super 5 1,0	85-92	BDX	TP.A-067	15,0			
Super 5 1,0	84-96	BDX	TP.A-011	18,0			
Super 5 1,0 Societe	85-87	BDX	TP.A-011	18,0			
Super 5 1,1	85-93	BDX	TP.A-067	15,0			
Super 5 1,1 Societe	85-	BDX	TP.A-011	18,0			
Super 5 1,2	87-90	BDX	TP.A-011	18,0			
Super 5 1,2 Societe	87-90	BDX	TP.A-011	18,0			
Super 5 1,4	84-89	BDX	TP.A-011	18,0			

Марка автомобиля	Годы выпуска автомобиля	Передние колодки			Задние колодки		
		Тип тормозной системы	№ по каталогу	Толщина изделия, мм	Тип тормозной системы	№ по каталогу	Толщина изделия, мм
RENAULT							
Super 5 1,4i	86-	BDX	TP.A-011	18,0			
Super 5 1,6 Diesel	86-	BDX	TP.A-011	18,0			
Super 5 1,6 Diesel Societe	87-90	BDX	TP.A-011	18,0			
Super 5 1,4 Turbo (C405)	04/85 – 08/90				BDX	TP.A-067	11,0
Super 5 1,7 (B/C408, B/C40K, B/C40G)	10/86 – 03/95	BDX	TP.A-011	18,0	BDX	TP.A-067	11,0
Super 5 1,7i (C409)	10/86 – 08/91				BDX	TP.A-067	11,0
Super 5 (B/C 40-) (10/84-12/96), 1.6D	04/85-12/96	TRW	TP.A-090	18,0			
Super 5 (B/C 40-) (10/84-12/96), 1.6	07/89-04/96	TRW	TP.A-090	18,0			
Super 5 (B/C 40-) (10/84-12/96), 1.6D	07/89-	TRW	TP.A-090	18,0			
Symbol 1,2 16V (LB0/1/2_)	04/02 –	TRW	TP.A-090	18,0			
Symbol 1,4 (16V) (LB0/1/2_)	08/00 –	TRW	TP.A-090	18,0			
Symbol 1,5 dCi (LB0/1/2_)	06/01 –	TRW	TP.A-090	18,0			
Symbol II 1,2 16V (LU2V)	09/08 –	TRW	TP.A-090	18,0			
Symbol II 1,5 dCi (LU1/2_)	09/08 –	TRW	TP.A-090	18,0			
Symbol II 1,6 16V (LU1/2_)	09/08 –	TRW	TP.A-090	18,0			
Thalia (LB 0/1/2-) (02/98-), 1.2 (16V)	02/98 -	TRW	TP.A-090	18,0	BDX	TP.A-067	11,0
Thalia (LB 0/1/2-) (02/98-), 1.4 16V, ABS(+), Ø238 mm	-10/03	TRW	TP.A-090	18,0			
Thalia (LB 0/1/2-) (02/98-), 1.4 16V, ABS(+), Ø259 mm	-10/03	TRW	TP.A-090	18,0			
Thalia (LB 0/1/2-) (02/98-), ABS(-), 1.4	08/00-	TRW	TP.A-090	18,0			
Thalia (LB 0/1/2-) (02/98-), 16V, 1.4 ABS(-), Ø238 mm	-10/03	TRW	TP.A-090	18,0			
Thalia (LB 0/1/2-) (02/98-), 1.4 16V, ABS(-), Ø238 mm	-10/03	TRW	TP.A-090	18,0			
Thalia (LB 0/1/2-) (02/98-), 1.5 dCi	-10/03	TRW	TP.A-090	18,0			
Thalia (LB 0/1/2-) (02/98-), 1.5 dCi, Ø259 mm	-10/03	TRW	TP.A-090	18,0			
Thalia (LB 0/1/2-) (02/98-), 1.5 dCi	06/01-	TRW	TP.A-090	18,0			
Thalia (LB 0/1/2-) (03/98-05/01), 1.6	12/99-	TRW	TP.A-090	18,0			
Thalia (LB 0/1/2-) (04/02-), 1.6, 16V	04/04-	TRW	TP.A-090	18,0			
Thalia (LB 0/1/2-) 1.6, 16V, 04/02-ABS(+)	-10/03	TRW	TP.A-090	18,0			
Thalia (LB 0/1/2-) 1.9D, ABS(-)	02/98-05/01	TRW	TP.A-090	18,0			
Thalia (LB 0/1/2-) (02/98-), 2,0	09/01-	TRW	TP.A-090	18,0			
Thalia (LB 0/1/2-) (02/98-), 3.0 V6 Turbo Sport	04/00-09/01	TRW	TP.A-090	18,0			
Thalia II 1,2 16V (LU2V)	09/08 –	TRW	TP.A-090	18,0			
Thalia II 1,5 dCi (LU1/2_)	09/08 –	TRW	TP.A-090	18,0			
Thalia II 1,6 16V (LU1/2_)	09/08 –	TRW	TP.A-090	18,0			
Tondar 90 (LS_) 1,4	09/04 –	TRW	TP.A-090	18,0			
Tondar 90 (LS_) 1,5 dCi	04/07 –	TRW	TP.A-090	18,0			
Twingo 1,2	96-	BDX	TP.A-067	15,0			
Twingo 1,2 Kat	93-	BDX	TP.A-067	15,0			

Марка автомобиля	Годы выпуска автомобиля	Передние колодки			Задние колодки		
		Тип тормозной системы	№ по каталогу	Толщина изделия, мм	Тип тормозной системы	№ по каталогу	Толщина изделия, мм
RENAULT							
Twingo (C 06-) (03/93-) -1.2, Ø238 mm	-06/98	TRW	TP.A-090	18,0			
Twingo (C 06-) (03/93-) -1.2, Ø259 mm	-06/98	TRW	TP.A-090	18,0			
Twingo (C 06-) (03/93-) 1.2, MTM Ø238 mm	03/93-	TRW	TP.A-090	18,0			
Twingo (C 06-) (03/93-) 1.2, MTM Ø259 mm	03/93-	TRW	TP.A-090	18,0			
Twingo (C 06-) (03/93-) 1.2, 16V, MTM Ø238 mm	01/01-	TRW	TP.A-090	18,0			
Twingo (C 06-) (03/93-) 1.2, 16V, MTM Ø259 mm	01/01-	TRW	TP.A-090	18,0			
Twingo (CN 0-) (03/07-), 1.2	08/07-	TRW	TP.A-090	18,0			
Twingo (CN 0-) (03/07-), 1.2 16V	08/07-	TRW	TP.A-090	18,0			
Twingo (CN 0-) (03/07-), 1.2 Turbo 03/07-	08/07-	TRW	TP.A-090	18,0			
Twingo (C 06-) (03/93-), 1.2 Ø238 mm	07/98-06/03	TRW	TP.A-090	18,0			
Twingo (C 06-) (03/93-), 1.2 Ø259 mm	07/98-06/03	TRW	TP.A-090	18,0			
Twingo (CN 0-) (03/07-), 1.5 dCi	08/07-	TRW	TP.A-090	18,0			
Twingo (CN0_) 1,2 TCe 100 (CN0P)	02/11 –	TRW	TP.A-090	18,0			
Twingo (CN0_) 1,5 dCi 75	10/10 –	TRW	TP.A-090	18,0			
Twingo (CN0_) 1,5 dCi 90	10/10 –	TRW	TP.A-090	18,0			
Twingo Box S (06-) (03/93-), 1.2 ABS(+)	09/98-08/00	TRW	TP.A-090	18,0			
Twingo Box S (06-) (03/93-), 1.2 Ø238mm	09/00-06/07	TRW	TP.A-090	18,0			
Twingo Box S (06-) (03/93-), 1.2 Ø229mm	09/00-06/07	TRW	TP.A-090	18,0			
ROVER							
214 (ABS)	89-	GIR	TP.A 026	17,5			
216 Hatch GSi (Standard fit)	90-	GIR	TP.A 026	17,5			
216, 216+ABS, 216 G, Si (Standard fit)	90-	GIR	TP.A 026	17,5			
218 (ABS)	91-	GIR	TP.A 026	17,5			
414 GSi, Si, Sli (ABS)	90-	GIR	TP.A 026	17,5			
414 GST (Standard fit)	90-	GIR	TP.A 026	17,5			
416 (ABS)	90-	GIR	TP.A 026	17,5			
418 (ABS)	91-	GIR	TP.A 026	17,5			
420 (ABS)	91-	GIR	TP.A 026	17,5			
820 all models	86-91	GIR	TP.A 026	17,5			
825 2,5 Si	86-88	GIR	TP.A 026	17,5			
825 all models	86-88	GIR	TP.A 026	17,5			
825 2,5i Sterling	86-88	GIR	TP.A 026	17,5			

Марка автомобиля	Годы выпуска автомобиля	Передние колодки			Задние колодки		
		Тип тормозной системы	№ по каталогу	Толщина изделия, мм	Тип тормозной системы	№ по каталогу	Толщина изделия, мм
ROVER							
825 2,5 Turbodiesel	90-91	GIR	TP.A 026	17,5			
827 Si, Shi, Sterling	88-91	GIR	TP.A 026	17,5			
827 2,7 Sterling	88-91	GIR	TP.A 026	17,5			
Rover Vitesse 2,7	88-91	GIR	TP.A 026	17,5			
25 (RF) (09/99-) 1.1	09/99-05/04	TRW	TP.A-074	18,0			
25 (RF) (09/99-) 1.1 16V	01/04-	TRW	TP.A-074	18,0			
25 (RF) (09/99-) 1.4 16V	10/99-	TRW	TP.A-074	18,0			
25 (RF) (09/99-) 1.6 16V	10/99-	TRW	TP.A-074	18,0			
25 (RF) (09/99-) 1.8 16V	10/99-	TRW	TP.A-074	18,0			
25 (RF) (09/99-) 2.0 iDT	10/99-	TRW	TP.A-074	18,0			
45 (RT) (02/00-) 1.4	02/00-	TRW	TP.A-074	18,0			
45 (RT) (02/00-) 1.6	-05/04	TRW	TP.A-074	18,0			
45 (RT) (02/00-) 1.8	-05/04	TRW	TP.A-074	18,0			
45 (RT) (02/00-) 2.0 V6	-05/04	TRW	TP.A-074	18,0			
45 (RT) (02/00-) 2.0 iDT	-05/04	TRW	TP.A-074	18,0			
45 Saloon (RT) (02/00-) 1.4	-05/04	TRW	TP.A-074	18,0			
45 Saloon (RT) (02/00-) 1.6	-05/04	TRW	TP.A-074	18,0			
45 Saloon (RT) (02/00-) 1.8	-05/04	TRW	TP.A-074	18,0			
45 Saloon (RT) (02/00-) 2.0 V6	-05/04	TRW	TP.A-074	18,0			
45 Saloon (RT) (02/00-) 2.0 iDT	-05/04	TRW	TP.A-074	18,0			
200 (RF) (11/95-03/00), 1.1 211	01/98-03/00	TRW	TP.A-074	18,0			
200 (RF) (11/95-03/00), 1.4	01/96-12/97	TRW	TP.A-074	18,0			
200 (RF) (11/95-03/00), 1.4 214i	11/95-03/00	TRW	TP.A-074	18,0			
200 (RF) (11/95-03/00), 1.4 214 Si ABS(+)	11/95-03/00	TRW	TP.A-074	18,0			
200 (RF) (11/95-03/00), 1.4 Si ABS(-)	11/95-03/00	TRW	TP.A-074	18,0			
200 (RF) (11/95-03/00), 1.4i	11/95-03/00	TRW	TP.A-074	18,0			
200 (RF) (11/95-03/00), 1.6 216 Si ABS(+)	11/95-03/00	TRW	TP.A-074	18,0			
200 (RF) (11/95-03/00), 1.6 216 Si ABS(-)	11/95-03/00	TRW	TP.A-074	18,0			
200 (RF) (11/95-03/00), 1.8 218K Vi	11/95-03/00	TRW	TP.A-074	18,0			
200 (RF) (11/95-03/00), 2.0 220 D/SD, ABS(+)	-06/99	TRW	TP.A-074	18,0			
200 (RF) (11/95-03/00), 2.0 220 SDi, ABS(+), ABS(-)	11/95-03/00	TRW	TP.A-074	18,0			
200 Coupe (XW) (10/92-06/99), 1.6, 216, ABS(+)	10/92-06/99	TRW	TP.A-074	18,0			
200 Coupe (XW) 2,0	10/92-09/97	TRW	TP.A-074	18,0			
200 Coupe (XW) 2,0 220 GSi 05/94-06/99	-09/97	TRW	TP.A-074	18,0			
200 Coupe (XW) 2,0 220 Turbo (10/92-06/99)	-12/95	TRW	TP.A-074	18,0			
200 Hatchback (XW) (10/89-10/95) 1.4 214, ABS(+)	09/93-10/95	TRW	TP.A-074	18,0			
200 Hatchback (XW) (10/89-10/95) 1.4, 214 GSi/Si, ABS(+) Ø238,3 mm	01/90-10/95	TRW	TP.A-074	18,0			

Марка автомобиля	Годы выпуска автомобиля	Передние колодки			Задние колодки		
		Тип тормозной системы	№ по каталогу	Толщина изделия, мм	Тип тормозной системы	№ по каталогу	Толщина изделия, мм
ROVER							
200 Hatchback (XW) (10/89-10/95) 1.4, 214 GSi/Si 01/90-10/95, ABS(+) Ø262,3 mm	01/90-10/95	TRW	TP.A-074	18,0			
200 Hatchback (XW) 1.4, 214 Si/GSi ABS(+)	10/89-10/95	TRW	TP.A-074	18,0			
200 Hatchback (XW) 1.6, 216 GSi ABS(+)	10/89-10/95	TRW	TP.A-074	18,0			
200 Hatchback (XW) (10/89-10/95) 1.6 216 GTi ABS(+)	09/90-10/95	TRW	TP.A-074	18,0			
200 Hatchback (XW) (10/89-10/95) 1.8 218 TD	09/91-10/95	TRW	TP.A-074	18,0			
200 Hatchback (XW) (10/89-10/95) 1.9, 218 D, ABS(+) Ø238,3 mm	09/91-10/95	TRW	TP.A-074	18,0			
200 Hatchback (XW) (10/89-10/95) 1.9, 218 D, ABS(+) Ø262,3 mm	09/91-10/95	TRW	TP.A-074	18,0			
200 Hatchback (XW) (10/89-10/95); 2.0 220 GTi	09/91-10/95	TRW	TP.A-074	18,0			
200 Hatchback (XW) (10/89-10/95); 2,0 220 Turbo 01/93-10/95	01/93-10/95	TRW	TP.A-074	18,0			
400 (RT) (05/95-03/00); 1.4 414 Si ABS(+)	10/92-02/96	TRW	TP.A-074	18,0			
400 (RT); 1.6 416 Si	05/95-03/00	TRW	TP.A-074	18,0			
400 (RT); 1.6 416 Si; ABS(+)	05/95-03/00	TRW	TP.A-074	18,0			
400 (RT) (05/95-03/00); 2,0 420 Si Lux, ABS(+)	12/95-03/00	TRW	TP.A-074	18,0			
400 (RT) (05/95-03/00) 2,0 420D	11/95-03/00	TRW	TP.A-074	18,0			
400 (RT) (05/95-03/00) 2,0 420Di	05/95-03/00	TRW	TP.A-074	18,0			
		TRW	TP.A-074	18,0			
400 (XW) 1.4 414 (ABS+) Ø238 mm	01/93-04/95	TRW	TP.A-074	18,0			
400 (XW) 1.4 414 GSi/Si Ø238 mm	04/90-04/95	TRW	TP.A-074	18,0			
400 (XW) 1.4 414 (ABS+) Ø262 mm	01/93-04/95	TRW	TP.A-074	18,0			
400 (XW) 1.4 414 GSI ABS(+) Ø262,3 mm	04/90-04/95	TRW	TP.A-074	18,0			
400 (XW) 1.6 416 GSI ABS(+)	04/90-04/95	TRW	TP.A-074	18,0			
400 (XW) 1.6 416 GSI/GSE ABS(+)	04/90-04/95	TRW	TP.A-074	18,0			
400 (XW) 1.6 416 GTI ABS(+)	04/90-04/95	TRW	TP.A-074	18,0			
400 (XW) 1.6 416 GTI/GTE ABS(+)	04/90-04/95	TRW	TP.A-074	18,0			
400 (XW) 1.8, 418D; ABS(+)	09/91-04/95	TRW	TP.A-074	18,0			
400 (XW) 1.8 418 TD	09/91-04/95	TRW	TP.A-074	18,0			
400 (XW) 2.0 420 GSI/SLI/GTI/Vite	01/93-04/95	TRW	TP.A-074	18,0			
400 (XW) 2.0 420 GTI/GSI Vitesse	02/92-04/95	TRW	TP.A-074	18,0			
400 (XW) 2.0 420 Turbo GSI Sport	10/92-04/95	TRW	TP.A-074	18,0			
400 Estate (XW) 1.6i	05/94-11/98	TRW	TP.A-074	18,0			
400 Estate (XW) 1.8i	06/96-11/98	TRW	TP.A-074	18,0			
400 Estate (XW) 1.8 TD ABS(+)	10/94-02/96	TRW	TP.A-074	18,0			
400 Estate (XW) 2.0i	10/94-02/96	TRW	TP.A-074	18,0			
400 Hatchback (RT) 1.4 414 ABS(+)	03/96-12/97	TRW	TP.A-074	18,0			
400 Hatchback (RT) 1.4 414 ABS(-)	03/96-12/97	TRW	TP.A-074	18,0			
400 Hatchback (RT) 1.4 414 Si ABS(+)	05/95-02/96	TRW	TP.A-074	18,0			
400 Hatchback (RT) 1.4 414 Si (ABS(-))	05/95-02/96	TRW	TP.A-074	18,0			
400 Hatchback (RT) 1.4 414 Si (ABS(+))	03/96-03/00	TRW	TP.A-074	18,0			

Марка автомобиля	Годы выпуска автомобиля	Передние колодки			Задние колодки		
		Тип тормозной системы	№ по каталогу	Толщина изделия, мм	Тип тормозной системы	№ по каталогу	Толщина изделия, мм
ROVER							
400 Hatchback (RT) 1.4 414 Si ABS(-)	03/96-03/00	TRW	TP.A-074	18,0			
400 Hatchback (RT) 1.6, ABS(+)	03/96-06/99	TRW	TP.A-074	18,0			
400 Hatchback (RT) 2.0 420D	11/95-06/99	TRW	TP.A-074	18,0			
800 (XS) (10/86-02/99) 2.0; 820 Sport	04/94-03/96	TRW	TP.A-074	18,0			
800 (XS) (10/86-02/99) 2.5; 825 Si Lux	04/96-02/99	TRW	TP.A-074	18,0			
800 (XS) (10/86-02/99) 2.5 825 D/8D	-10/98	TRW	TP.A-074	18,0			
800 (XS) (10/86-02/99) 2.7 827 SL Sterling	02/88-02/99	TRW	TP.A-074	18,0			
800 (XS) (10/86-02/99) 2.7 827 SL Sterling Ø262 mm	01/93-01/96	TRW	TP.A-074	18,0			
800 (XS) (10/86-02/99) 2.7 827 SL Sterling Ø285 mm	01/93-01/96	TRW	TP.A-074	18,0			
800 Coupe (08/92-02/99) 2.5 825 Si	-10/98	TRW	TP.A-074	18,0			
800 Coupe (08/92-02/99) 2.5 825 SD	09/93-10/98	TRW	TP.A-074	18,0			
800 Coupe (08/92-02/99) 2.7 827 24V	10/93-01/96	TRW	TP.A-074	18,0			
800 Hatchback XS (10/86-02/99) 2.0 820 16V Turbo	01/93-10/98	TRW	TP.A-074	18,0			
800 Hatchback XS (10/86-02/99) 2.0 820 Sport	04/94-03/96	TRW	TP.A-074	18,0			
800 Hatchback xs (10/86-02/99) 2.5	02/96-10/98	TRW	TP.A-074	18,0			
800 Hatchback xs (10/86-02/99) 2.5i	02/96-10/98	TRW	TP.A-074	18,0			
800 Hatchback xs (10/86-02/99) 2.5 825 D/SD	01/92-02/99	TRW	TP.A-074	18,0			
800 Hatchback xs (10/86-02/99) 2.7 24 VI/SI	01/93-01/96	TRW	TP.A-074	18,0			
Cabriolet (XW) (04/90-11/99) 1.4 214 ABS(+) Ø238,3 mm	04/90-02/92	TRW	TP.A-074	18,0			
Cabriolet (XW) (04/90-11/99) 1.4 214 ABS(+) Ø262,3 mm	04/90-02/92	TRW	TP.A-074	18,0			
Cabriolet (XW) (04/90-11/99) 1.4 214 ABS(+) Ø238,3 mm	-09/97	TRW	TP.A-074	18,0			
Cabriolet (XW) (04/90-11/99) 1.4 214 16V ABS(+) Ø238,3 mm	01/93-11/99	TRW	TP.A-074	18,0			
Cabriolet (XW) (04/90-11/99) 1.4 214 ABS(+) Ø262,0 mm	01/93-11/99	TRW	TP.A-074	18,0			
Cabriolet (XW) (04/90-11/99) 1.4 214 ABS(+) 16V Ø262,0 mm	-09/97	TRW	TP.A-074	18,0			
Cabriolet (XW) (04/90-11/99) 1.4i 214 16V ABS(+) Ø262,3 mm	-09/97	TRW	TP.A-074	18,0			
Cabriolet (XW) (04/90-02/96) 1.6	04/90-02/96	TRW	TP.A-074	18,0			
Cabriolet (XW) 1.6i 216 ABS(+)	01/92-11/99	TRW	TP.A-074	18,0			
Cabriolet (XW) 1.6i 216 16V ABS(+)	01/96-11/99	TRW	TP.A-074	18,0			
Coupe (XW) 1.6 16V ABS(+)	03/96-11/99	TRW	TP.A-074	18,0			
Coupe 1.8 16V	03/96-11/99	TRW	TP.A-074	18,0			
Streetwise 1,4	08/03 – 05/05	TRW	TP.A-074	17,5			
Streetwise 2,0 TD	08/03 – 05/05	TRW	TP.A-074	17,5			

Марка автомобиля	Годы выпуска автомобиля	Передние колодки			Задние колодки		
		Тип тормозной системы	№ по каталогу	Толщина изделия, мм	Тип тормозной системы	№ по каталогу	Толщина изделия, мм
SAAB							
90 2,0 (Sedan)	84-87	GIR	TP.A-069	16,3			
99 2,0 all models	74-80	GIR	TP.A-069	16,3			
99 2,0 GL all models	74-85	GIR	TP.A-069	16,3			
99 2,0 Turbo all models	79-80	GIR	TP.A-069	16,3			
99 2,0 GL	68-74	ATE	TP.A 001	15,0			
99 2,0 GL / GLE	88-				ATE	TP.A 008	15,0
900 2,0 GL all models	79-85	GIR	TP.A-069	16,3			
900 2,0 GLS all models	79-84	GIR	TP.A-069	16,3			
900 2,0 Turbo	86-88	GIR	TP.A-069	16,3			
900 2,0 Turbo 16V	84-87	GIR	TP.A-069	16,3			
900 2,0 Turbo 16V	85-88	GIR	TP.A-069	16,3			
900 2,0 Turbo, CD798-85	79-85	GIR	TP.A-069	16,3			
900 2,0i 16 V	88-89	GIR	TP.A-069	16,3			
900 2,0i GLi, GLE	80-85	GIR	TP.A-069	16,3			
900 2,0i Turbo 16 V	85-89	GIR	TP.A-069	16,3			
900 2,0 (2-doors)	86-87				ATE	TP.A-008	15,0
900 2,0 GL, GLS, GLE (ABS)	87-	GIR	TP.A 020	17,0			
900 2,0 Turbo, T8 (ABS)	87-	GIR	TP.A 020	17,0			
900 2,0 Cabrio 16V (ABS)	87-	GIR	TP.A 020	17,0	ATE	TP.A-008	15,0
900 2,0 16V Turbo (ABS)	87-	GIR	TP.A 020	17,0	ATE	TP.A-008	15,0
900 2,0 Turbo 16V Cabrio (ABS)	87-	GIR	TP.A 020	17,0	ATE	TP.A-008	15,0
900 2,0 16V Turbo, S	87-	GIR	TP.A 020	17,0	ATE	TP.A-008	15,0
900 2,0 16V Turbo Griffin	89-	GIR	TP.A 020	17,0	ATE	TP.A-008	15,0
900 2,0 16V Turbo Griffin ATE	89-				ATE	TP.A-008	15,0
900 2,0i (ABS)	87-	GIR	TP.A 020	17,0	ATE	TP.A-008	15,0
900 2,0i Turbo 81 / 110	87-89	GIR	TP.A 020	17,0			
900 2,0i all models	11/93-97	ATE	TP.A-066	18,0 17,0			
900 2,0i all models	97-	ATE	TP.A-066	18,0 17,0	ATE	TP.A-010	15,5
900 2,1i 16V Cabrio (ABS)	89-				ATE	TP.A-008	15,0
900 2,3i all models	11/93-97	ATE	TP.A-066	18,0 17,0			
900 2,3i all models	97-	ATE	TP.A-066	18,0 17,0	ATE	TP.A 010	15,5
900 2,5i all models	11/93-	ATE	TP.A-066	18,0 17,0			
900 I Combi Coupe 2,0-16	01/89 – 08/92				ATE	TP.A-008	15,0
900 I Combi Coupe 2,0i	11/80 – 08/90	GIR	TP.A-069	16,3	ATE	TP.A-008	15,0
900 I Combi Coupe 2,0 Turbo	10/86 – 12/91	GIR	TP.A-069	16,3			
900 I Combi Coupe 2,0 Turbo-16 (Turbo-16 S)	02/84 – 06/94	GIR	TP.A-069	16,3	ATE	TP.A-008	15,0
900 I Combi Coupe 2,1-16	09/90 – 07/93				ATE	TP.A-008	15,0
900 II Cabrio 2,0i (Turbo)	12/93 – 02/98	ATE	TP.A-066	17,0 / 18,0			

Марка автомобиля	Годы выпуска автомобиля	Передние колодки			Задние колодки		
		Тип тормозной системы	№ по каталогу	Толщина изделия, мм	Тип тормозной системы	№ по каталогу	Толщина изделия, мм
SAAB							
900 II Cabrio 2,3-16	12/93 – 02/98	ATE	TP.A-066	17,0 / 18,0			
900 II Cabrio 2,5-24 V6	12/93 – 02/98	ATE	TP.A-066	17,0 / 18,0			
900 II Coupe 2,0i (Turbo)	12/93 – 02/98	ATE	TP.A-066	17,0 / 18,0			
900 II Coupe 2,3-16	12/93 – 02/98	ATE	TP.A-066	17,0 / 18,0			
900 II Coupe 2,5-24 V6	12/93 – 02/98	ATE	TP.A-066	17,0 / 18,0			
9000 2,0 Diesel CD	88-				ATE	TP.A-008	15,0
9000 2,0 16V Turbo	88-				ATE	TP.A-008	15,0
9000 2,0i (ABS)	84-87	GIR	TP.A 020	17,0	ATE	TP.A-008	15,0
9000 2,0i Griffin	89-				ATE	TP.A-008	15,0
9000 2,0i 16V CS (ABS)	84-87	GIR	TP.A 020	17,0	ATE	TP.A-008	15,0
9000 2,0i 16V T16 CD (ABS)	90-	GIR	TP.A 020	17,0	ATE	TP.A-008	15,0
9000 2,0i 16V Turbo CD (ABS)	84-87	GIR	TP.A 020	17,0	ATE	TP.A-008	15,0
9000 2,3 16V CSE, CSE S (ABS)	84-	GIR	TP.A 020	17,0			
9000 2,3i Turbo CD, CS (ABS)	84-87	GIR	TP.A 020	17,0	ATE	TP.A-008	15,0
9000 3,0i V6 24V CD/CS	93-	ATE	TP.A-066	18,0 / 17,0			
SCANIA							
4-Series (360, 460, 530 л.с.)	1995 –	KNORR SB 7000	TP.A-115	30,0	KNORR SB 7000	TP.A-115	30,0
4-Series (220, 260, 300, 310, 340, 400, 420 л.с.)	1996 –	KNORR SB 7000	TP.A-115	30,0	KNORR SB 7000	TP.A-115	30,0
4-Series (380, 381 л.с.)	1998 –	KNORR SB 7000	TP.A-115	30,0	KNORR SB 7000	TP.A-115	30,0
4-Series (230 л.с.)	1999 –	KNORR SB 7000	TP.A-115	30,0	KNORR SB 7000	TP.A-115	30,0
4-Series (269, 299, 322, 379, 419, 469, 579 л.с.)	–	KNORR SB 7000	TP.A-115	30,0	KNORR SB 7000	TP.A-115	30,0
4-Series (480, 580 л.с.)	2000 –	KNORR SB 7000	TP.A-115	30,0	KNORR SB 7000	TP.A-115	30,0
4-Series (440, 470 л.с.)	2001 –	KNORR SB 7000	TP.A-115	30,0	KNORR SB 7000	TP.A-115	30,0
P,G,R,T-Series (260, 280, 300, 559, 579, 619 л.с.)	–	KNORR SB 7000	TP.A-115	30,0	KNORR SB 7000	TP.A-115	30,0
P,G,R,T-Series (230, 270, 310, 340, 380 л.с.)	2004 –	KNORR SB 7000	TP.A-115	30,0	KNORR SB 7000	TP.A-115	30,0
P,G,R,T-Series (420, 469, 500, 560, 580 л.с.)	2004 –	KNORR SB 7000	TP.A-115	30,0	KNORR SB 7000	TP.A-115	30,0
P,G,R,T-Series (470 л.с.)	2004 – 2005	KNORR SB 7000	TP.A-115	30,0	KNORR SB 7000	TP.A-115	30,0
P,G,R,T-Series (620 л.с.)	2005 –	KNORR SB 7000	TP.A-115	30,0	KNORR SB 7000	TP.A-115	30,0
P,G,R,T-Series (269, 381, 480 л.с.)	2006 –	KNORR SB 7000	TP.A-115	30,0	KNORR SB 7000	TP.A-115	30,0
P,G,R,T-Series (379, 400, 441 л.с.)	2008 –	KNORR SB 7000	TP.A-115	30,0	KNORR SB 7000	TP.A-115	30,0
P,G,R,T-Series (360 л.с.)	2009 –	KNORR SB 7000	TP.A-115	30,0	KNORR SB 7000	TP.A-115	30,0
P,G,R,T-Series (440, 730 л.с.)	2010 –	KNORR SB 7000	TP.A-115	30,0	KNORR SB 7000	TP.A-115	30,0

Марка автомобиля	Годы выпуска автомобиля	Передние колодки			Задние колодки		
		Тип тормозной системы	№ по каталогу	Толщина изделия, мм	Тип тормозной системы	№ по каталогу	Толщина изделия, мм
SEAT							
13 1,5 Sofim	84-	BDX	TP.A 033	18,0			
Alhambra 1,9 TDi	96-	ATE	TP.A 019	19,5	GIR	TP.A-014	17,4
Alhambra 2,0 CLX	96-	ATE	TP.A 019	19,5	GIR	TP.A-014	17,4
Alhambra 1,9i	96-	ATE	TP.A 019	19,5			
Alhambra 2,0i	96-	ATE	TP.A 019	19,5			
Alhambra (7V8, 7V9) 1,8 T 20V	10/97 – 03/10	ATE	TP.A-019	19,5			
Alhambra (7V8, 7V9) 1,9 TDI 4 motion	06/00 – 03/10	ATE	TP.A-019	19,5			
Alhambra (7V8, 7V9) 2,0 TDI	11/05 – 03/10	ATE	TP.A-019	19,5			
Alhambra (7V8, 7V9) 2,8 V6 4 motion	06/00 – 03/10	ATE	TP.A-019	19,5			
Altea (5P1) 1.4, 16V	05/06-	ATE	TP.A-092/ TP.A-093	19,8			
Altea (5P1) 1.4 tsi	11/07-	ATE	TP.A-092/ TP.A-093	19,8			
Altea 1.6	03/04-	ATE	TP.A-092/ TP.A-093	19,8			
Altea 1,8 TFSI	01/07-	ATE	TP.A-092/ TP.A-093	19,8			
Altea 1,9 TDI	04/07-	ATE	TP.A-092/ TP.A-093	19,8			
Altea 2.0 FSI	05/04-	ATE	TP.A-092/ TP.A-093	19,8			
Altea 2.0 TFSI	04/06-	ATE	TP.A-092/ TP.A-093	19,8			
Altea 2.0 TDI	06/05-	ATE	TP.A-092/ TP.A-093	19,8			
Altea 2.0 TDI 16V	06/05-	ATE	TP.A-092/ TP.A-093	19,8			
Altea (5P1) 1,6 LPG	09/09 –	ATE	TP.A-093	19,8			
Altea XL (5P5, 5P8) 1,6 LPG	09/09 –	ATE	TP.A-093	19,8			
Altea XL (5P5) 1.6	10/06-	ATE	TP.A-092/ TP.A-093	19,8			
Altea XL (5P5) 1.6 Multifuel	10/06-	ATE	TP.A-092/ TP.A-093	19,8			
Altea XL (5P5) 1,8 TFSI 4x4	06/07-	ATE	TP.A-092/ TP.A-093	19,8			
Altea XL (5P5) 1,9 TDI	10/06-	ATE	TP.A-092/ TP.A-093	19,8			
Altea XL (5P5) 2,0 FSI	10/06-	ATE	TP.A-092/ TP.A-093	19,8			
Altea XL (5P5) 2,0 TFSI 4x4	06/07-	ATE	TP.A-092/ TP.A-093	19,8			
Altea XL (5P5) 2,0 TDI	10/06-	ATE	TP.A-092/ TP.A-093	19,8			
Altea XL (5P5) TDI	10/06-	ATE	TP.A-092/ TP.A-093	19,8			
Altea XL (5P5) TDI 4x4	06/07-	ATE	TP.A-092/ TP.A-093	19,8			

Марка автомобиля	Годы выпуска автомобиля	Передние колодки			Задние колодки		
		Тип тормозной системы	№ по каталогу	Толщина изделия, мм	Тип тормозной системы	№ по каталогу	Толщина изделия, мм
SEAT							
Cordoba Sedan (6K1, 6K2) 1,6i	02/93 – 06/96	GIR	TP.A-003	19,4			
Cordoba Sedan (6K1, 6K2) 1,8i 16V	10/93 – 08/96	GIR	TP.A-003	16,5	GIR	TP.A-014	15,0
Cordoba Sedan (6K1, 6K2) 1,9 TDI	08/96 – 06/99	GIR	TP.A-003	19,4	GIR	TP.A-014	15,0
Cordoba Sedan (6K1, 6K2) 2,0i	02/93 – 06/99				GIR	TP.A-014	15,0
Cordoba Sedan (6K1, 6K2) 2,0i 16V	08/96 – 06/99				GIR	TP.A-014	15,0
Cordoba Sedan (6L2) 1,2 12V	10/02 – 11/09	ATE	TP.A-065 TP.A-092 TP.A-093	19,8			
Cordoba Sedan (6L2) 1,4 16V	09/02 – 11/09	ATE	TP.A-065 TP.A-092 TP.A-093	19,8			
Cordoba Sedan (6L2) 1,4 TDI	10/02 – 11/09	ATE	TP.A-065 TP.A-092 TP.A-093	19,8			
Cordoba Sedan (6L2) 1,6 16V	04/03 – 11/09	ATE	TP.A-065 TP.A-092 TP.A-093	19,8			
Cordoba Sedan (6L2) 1,9 SDI / TDI	09/02 – 11/09	ATE	TP.A-065 TP.A-092 TP.A-093	19,8			
Cordoba Sedan (6L2) 2,0	09/02 – 11/09	ATE	TP.A-065 TP.A-092 TP.A-093	19,8			
Cordoba Vario (6K5) 1,4 16V	06/99 – 12/02	GIR	TP.A-003	19,4			
Cordoba Vario (6K5) 1,9 TDI	08/96 – 12/02	GIR	TP.A-003	19,4	GIR	TP.A-014	15,0
Exeo (3R2) 1,6	03/09 – 09/10				GIR	TP.A-014	15,0
Exeo (3R2) 1,8 T	12/08 – 05/10				GIR	TP.A-014	15,0
Exeo (3R2) 1,8 TSI	05/10 –				GIR	TP.A-014	15,0
Exeo (3R2) 2,0 TDI	12/08 –				GIR	TP.A-014	15,0
Exeo (3R2) 2,0 TFSI	03/09 –				GIR	TP.A-014	15,0
Exeo ST (3R5) 1,6	06/09 – 09/10				GIR	TP.A-014	15,0
Exeo ST (3R5) 1,8 T	06/09 – 05/10				GIR	TP.A-014	15,0
Exeo ST (3R5) 1,8 TSI	05/10 –				GIR	TP.A-014	15,0
Exeo ST (3R5) 2,0 TDI	05/09 –				GIR	TP.A-014	15,0
Exeo ST (3R5) 2,0 TFSI	05/10 –				GIR	TP.A-014	15,0
Ibiza 0,9 J Mathc	85-	BDX	TP.A 033	18,0			
Ibiza 1,0i	96-	VAG	TPA 024025	17,3			
Ibiza 1,0i CL	93-	ATE	TP.A 024	17,3			
Ibiza 1,0i GL	94-	VAG	TPA 024025	17,3			
Ibiza 1,2 Disco, Crono	88-	BDX	TP.A 033	18,0			

Марка автомобиля	Годы выпуска автомобиля	Передние колодки			Задние колодки		
		Тип тормозной системы	№ по каталогу	Толщина изделия, мм	Тип тормозной системы	№ по каталогу	Толщина изделия, мм
SEAT							
Ibiza 1,2 GLX / LE / L / GL	84-90	BDX	TP.A 033	18,0			
Ibiza 1,2 Li / GLi / XLi	90-	BDX	TP.A 033	18,0			
Ibiza 1,3 CLX, GLX	93-94	VAG	TPA 024025	19,5			
Ibiza 1,3i CL, CLX, GLX	93-	ATE	TP.A 024	17,3			
Ibiza 1,4 all models	93-	ATE	TP.A 024	17,3			
Ibiza 1,4	94-	VAG	TPA 024025	19,5			
Ibiza 1,4	96-	VAG	TPA 024025	19,5			
Ibiza 1,5 GL / GLX	84-	BDX	TP.A 033	18,0			
Ibiza 1,5 Super Special Sxi Xh / GLX	88-	BDX	TP.A 033	18,0			
Ibiza 1,5i Sxi, Super Sxi	88-	BDX	TP.A 033	18,0			
Ibiza 1,6 all models	93-94	ATE	TPA 024025	19,5			
Ibiza 1,6 all models	94-	ATE	TP.A 024	17,3			
Ibiza 1,6i CLX, GLX	99-	VAG	TPA 024025	19,5			
Ibiza 1,6i	96-	VAG	TPA 024025	19,5			
Ibiza 1,8 CLX, GLX	93-	ATE	TPA 024025	19,5			
Ibiza 1,8 GLX	93-94	ATE	TPA 024025	15,3			
Ibiza 1,8 GTi 16V	93-	GIR	TP.A 003	16,2	GIR	TP.A 014	15,0
Ibiza 1,8i CLX, GLX	93-	VAG	TPA 024025	19,5			
Ibiza 1,8i	96-	VAG	TPA 024025	19,5			
Ibiza 1,9	96-	VAG	TPA 024025	19,5			
Ibiza 1,9 D CLX	93-94	ATE	TPA 024025	15,3			
Ibiza 1,9 D CL, CLX	93-	VAG	TPA 024025	19,5			
Ibiza 1,9 D CLX, TD GLX	94-	ATE	TPA 024025	19,5			
Ibiza 1,9 Diesel CL, CLX	93-	VAG	TPA 024025	19,5			
Ibiza 1,9 TD, GLX	93-	VAG	TPA 024025	19,5			
Ibiza 2,0 GTi (ABS)	93-	GIR	TP.A 003	16,2	GIR	TP.A 014	15,0
Ibiza IV (6L1) (02/02-) 1.2	02/02-05/08	ATE	TP.A-092/ TP.A-093	19,8			
Ibiza IV (6L1) (02/02-) 1.2 12V	-05/06	ATE	TP.A-092/ TP.A-093	19,8			
Ibiza IV (6L1) (02/02-) 1.4 16V	02/02-	ATE	TP.A-092/ TP.A-093	19,8			

Марка автомобиля	Годы выпуска автомобиля	Передние колодки			Задние колодки		
		Тип тормозной системы	№ по каталогу	Толщина изделия, мм	Тип тормозной системы	№ по каталогу	Толщина изделия, мм
SEAT							
Ibiza IV (6L1) (02/02-) 1.4 TDI	05/02-	ATE	TP.A-092/ TP.A-093	19,8			
Ibiza IV (6L1) (02/02-) 1.6	02/03-	ATE	TP.A-092/ TP.A-093	19,8			
Ibiza IV (6L1) (02/02-) 1.6 16V	11/06-	ATE	TP.A-092/ TP.A-093	19,8			
Ibiza IV (6L1) 1.8 T Cupra R TFR	12/03-05/08	ATE	TP.A-092/ TP.A-093	19,8			
Ibiza IV (6L1) 1.9 SDI	02/02-12/05	ATE	TP.A-092/ TP.A-093	19,8			
Ibiza IV (6L1) 1.9 TDI	02/02-	ATE	TP.A-092/ TP.A-093	19,8			
Ibiza IV (6L1) 2.0	04/02-	ATE	TP.A-092/ TP.A-093	19,8			
Ibiza V (6J5) 1.2	03/08-	ATE	TP.A-092/ TP.A-093	19,8			
Ibiza V (6J5) 1.4	03/08-	ATE	TP.A-092/ TP.A-093	19,8			
Ibiza V (6J5) 1.4 TDI	07/08-	ATE	TP.A-092/ TP.A-093	19,8			
Ibiza V (6J5) 1.6	05/08-	ATE	TP.A-092/ TP.A-093	19,8			
Ibiza V (6J5) 1.9 TDI	03/08-	ATE	TP.A-092/ TP.A-093	19,8			
Ibiza V (6J5) 1,2 TDI	05/10 –	ATE	TP.A-065 TP.A-092 TP.A-093	19,8			
Ibiza V (6J5) 1,2 TSI	09/10 –	ATE	TP.A-065 TP.A-092 TP.A-093	19,8			
Ibiza V (6J5) 2,0 TDI	01/10 –	ATE	TP.A-065 TP.A-092 TP.A-093	19,8			
Ibiza V Coupe 6J1 (07/08-) 1.2	07/08-	ATE	TP.A-092/ TP.A-093	19,8			
Ibiza V Sportcoupe (6J1) 1,2 TDI / TSI	05/10 –	ATE	TP.A-065 TP.A-092 TP.A-093	19,8			
Ibiza V Sportcoupe (6J1) 1,4	07/08 –	ATE	TP.A-092 TP.A-093	19,8			
Ibiza V Sportcoupe (6J1) 1,4 TDI	07/08 – 06/10	ATE	TP.A-065 TP.A-092 TP.A-093	19,8			
Ibiza V Sportcoupe (6J1) 1,6	07/08 –	ATE	TP.A-065 TP.A-092 TP.A-093	19,8			
Ibiza V Sportcoupe (6J1) 1,6 LPG	05/11 –	ATE	TP.A-065	19,8			
Ibiza V Sportcoupe (6J1) 1,6 TDI	05/09 –	ATE	TP.A-065 TP.A-092 TP.A-093	19,8			
Ibiza V Sportcoupe (6J1) 1,9 TDI	07/08 – 06/10	ATE	TP.A-065 TP.A-092 TP.A-093	19,8			

Марка автомобиля	Годы выпуска автомобиля	Передние колодки			Задние колодки		
		Тип тормозной системы	№ по каталогу	Толщина изделия, мм	Тип тормозной системы	№ по каталогу	Толщина изделия, мм
SEAT							
Ibiza V Sportcoupe (6J1) 2,0 TDI	01/10 –	ATE	TP.A-065 TP.A-092 TP.A-093	19,8			
Ibiza V ST (6J8) 1,2	05/10 –	ATE	TP.A-065 TP.A-092 TP.A-093	19,8			
Ibiza V ST (6J8) 1,2 TDI / TSI	04/10 –	ATE	TP.A-065 TP.A-092 TP.A-093	19,8			
Ibiza V ST (6J8) 1,4 TSI	03/10 –	ATE	TP.A-065 TP.A-092 TP.A-093	19,8			
Ibiza V ST (6J8) 1,6	02/12 –	ATE	TP.A-065	19,8			
Ibiza V ST (6J8) 1,6 TDI	03/10 –	ATE	TP.A-065 TP.A-092 TP.A-093	19,8			
Inca 1,4i	95-	GIR	TP.A 003	19,4			
Inca 1,6i	95-	GIR	TP.A 003	19,4			
Inca 1,9 Diesel ISDI	95-	GIR	TP.A 003	19,4			
Inca 1,7 D	95-	GIR	TP.A 003	19,6			
Leon (1M1) (11/99-06/06) 1.4 16V	11/99-06/06	ATE	TP.A-092/ TP.A-093	19,8			
Leon (1M1) 1.6	11/99-06/06	ATE	TP.A-092/ TP.A-093	19,8			
Leon (1M1) 1.6 16V	09/00-06/06	ATE	TP.A-092/ TP.A-093	19,8			
Leon (1M1) 1.8 20V	11/99-06/06	ATE	TP.A-092/ TP.A-093	19,8			
Leon (1M1) 1.8 20V T	11/99-06/06	ATE	TP.A-092/ TP.A-093	19,8			
Leon (1M1) 1.8 20V T4	11/99-06/06	ATE	TP.A-092/ TP.A-093	19,8			
Leon (1M1) 1.9 SDI	11/99-06/06	ATE	TP.A-092/ TP.A-093	19,8			
Leon (1M1) 1.6	11/99-06/06	ATE	TP.A-092/ TP.A-093	19,8			
Leon (1M1) 1.9 TDI Ø256,0 mm	-12/99	ATE	TP.A-092/ TP.A-093	19,8			
Leon (1M1) 1.9 TDI Ø280,0 mm	-12/99	ATE	TP.A-092/ TP.A-093	19,8			
Leon (1M1) 1.9 TDI Syncro	05/02-06/06	ATE	TP.A-092/ TP.A-093	19,8			
Leon (1M1) 2.3 VR5	09/00-11/03	ATE	TP.A-092/ TP.A-093	19,8			
Leon (1P1) (05/05-) 1.4 16V	06/06-	ATE	TP.A-092/ TP.A-093	19,8			
Leon (1P1) (05/05-) 1.4 TSI	11/07-	ATE	TP.A-092/ TP.A-093	19,8			
Leon (1P1) (05/05-) 1.6	07/05-	ATE	TP.A-092/ TP.A-093	19,8			
Leon (1P1) (05/05-) 1.9 TDi 14"	07/05-	ATE	TP.A-092/ TP.A-093	19,8			

Марка автомобиля	Годы выпуска автомобиля	Передние колодки			Задние колодки		
		Тип тормозной системы	№ по каталогу	Толщина изделия, мм	Тип тормозной системы	№ по каталогу	Толщина изделия, мм
SEAT							
Leon (1P1) (05/05-) 1.9 TDi 15"	07/05-	ATE	TP.A-092/ TP.A-093	19,8			
Leon (1P1) (05/05-) 2.0 TFSI	05/05-	ATE	TP.A-092/ TP.A-093	19,8			
Leon (1P1) (05/05-) 2.0 TDI	07/05-	ATE	TP.A-092/ TP.A-093	19,8			
Leon (1P1) (05/05-) 2.0 16V	07/05-	ATE	TP.A-092/ TP.A-093	19,8			
Leon (1P1) 1,2 TSI	02/10 –	ATE	TP.A-093	19,8			
Leon (1P1) 1,6 TDI	02/10 –	ATE	TP.A-093	19,8			
Malaga 1,2 GLX/ LE Plus/L/ GL	85-89	BDX	TP.A 033	18,0			
Malaga 1,5 GL / GLS / GLX / L	85-89	BDX	TP.A 033	18,0			
Malaga 1,5i	85-89	BDX	TP.A 033	18,0			
Malaga 1,7 Diesel GLD / GLS / L	85-89	BDX	TP.A 033	18,0			
Marbella 0,8 (Van)	08/86-12/83	BDX	TP.A 033	18,0			
Marbella 0,9 L / LE / GL / GLX	87-96	BDX	TP.A 033	18,0			
Marbella 0,9 Van	87-93	BDX	TP.A 033	18,0			
Panda <E>	84-	BDX	TP.A 033	18,0			
Ritmo <E>	82-86	BDX	TP.A 033	18,0			
Ronda 1,2 GLX	83-84	BDX	TP.A 033	18,0			
Ronda 1,2 GLX (Porsche)	84-	BDX	TP.A 033	18,0			
Ronda 1,2 L / GL	83-84	BDX	TP.A 033	18,0			
Ronda 1,2 L / GL (Porsche)	84-	BDX	TP.A 033	18,0			
Ronda 1,2 LE	83-84	BDX	TP.A 033	18,0			
Ronda 1,2 LE (Porsche)	84-88	BDX	TP.A 033	18,0			
Ronda 1,4 (022A)	06/82-11/88	BDX	TP.A 033	18,0			
Ronda 1,5 GL / GLX	83-84	BDX	TP.A 033	18,0			
Ronda 1,5 GL / GLX (Porsche)	84-	BDX	TP.A 033	18,0			
Ronda 1,5 SX	83-84	BDX	TP.A 033	18,0			
Ronda 1,5 SX (Porsche)	84-87	BDX	TP.A 033	18,0			
Ronda 1,6 (022A)	08/83-09/85	BDX	TP.A 033	18,0			
Ronda 1,7 Diesel	83-84	BDX	TP.A 033	18,0			
Ronda 1,7 Diesel (Porsche)	84-	BDX	TP.A 033	18,0			
Terra 0,9 Combi	88-	BDX	TP.A 033	18,0			
Terra Diesel (VW motor)	90-	BDX	TP.A 033	18,0			
Toledo 1,4	90-	VAG	TPA 024025	19,5			
Toledo 1,6 CL, GL, GLX	91-	VAG	TPA 024025	19,5			
Toledo 1,6 GL	91-	VAG	TPA 024025	19,5			
Toledo 1,6 SE, SXE (ABS)	97-				GIR	TP.A 014	15,0
Toledo 1,6i	91-	VAG	TPA 024025	19,5			

Марка автомобиля	Годы выпуска автомобиля	Передние колодки			Задние колодки		
		Тип тормозной системы	№ по каталогу	Толщина изделия, мм	Тип тормозной системы	№ по каталогу	Толщина изделия, мм
SEAT							
Toledo 1,6i CL, GL (ABS)	91-	GIR	TP.A 003	16,5			
Toledo 1,6i CL, GL, GLX, Sport	91-	ATE	TPA 024025	19,5			
Toledo 1,6i 16V	95-				GIR	TP.A 014	15,0
Toledo 1,8 SE, SXE	97-				GIR	TP.A 014	15,0
Toledo 1,8i	91-	VAG	TPA 024025	19,5			
Toledo 1,8i CL, GL, GLX, 16V (ABS)	91-	GIR	TP.A 003	16,5	GIR	TP.A 014	15,0
Toledo 1,8i GL, GLX	91-	VAG	TPA 024025	19,5			
Toledo 1,8i GL, GLX	93-	VAG	TPA 024025	19,5			
Toledo 1,8i 16V GT (ABS)	91-94				GIR	TP.A 014	15,0
Toledo 1,9 D CL	91-92	VAG	TPA 024025	19,5			
Toledo 1,9 D CL, GL, TD GL, GLX Taxi	91-	ATE	TPA 024025	19,5			
Toledo 1,9 D, TD, TDi	97-				GIR	TP.A 014	15,0
Toledo 1,9 SDi	95-	VAG	TPA 024025	19,5			
Toledo 1,9 TD Turbo GLX (ABS)	91-	GIR	TP.A 003	16,5			
Toledo 1,9 TDi	95-96	GIR	TP.A 003	19,6			
Toledo 1,9 TDi	96-	GIR	TP.A 003	16,5			
Toledo 1,9 Turbo D	91-	ATE	TPA 024025	19,5			
Toledo 1,9 Turbo Diesel GL, GLX	91-	VAG	TPA 024025	19,5			
Toledo 2,0 16V GT	93-	GIR	TP.A 003	19,4	GIR	TP.A 014	15,0
Toledo 2,0i CL, GL, GLX, GT, Sport (ABS)	91-	GIR	TP.A 003	19,4	GIR	TP.A 014	15,0
Toledo 2,0i CL, GL, GLX, GT, Sport (ABS)	91-	GIR	TP.A 003	16,5	GIR	TP.A 014	15,0
Toledo 2,0i GL, GLX, GT (ABS)	91-	GIR	TP.A 003	16,5	GIR	TP.A 014	15,0
Toledo II (1M2) 1.4 16V	07/99-05/06	ATE	TP.A-092/ TP.A-093	19,8			
Toledo II (1M2) 1.6	04/99-05/06	ATE	TP.A-092/ TP.A-093	19,8			
Toledo II (1M2) 1.6 16V	09/00-05/06	ATE	TP.A-092/ TP.A-093	19,8			
Toledo II (1M2) 1.8	05/01-10/05	ATE	TP.A-092/ TP.A-093	19,8			
Toledo II (1M2) 1.8 20V	04/99-05/06	ATE	TP.A-092/ TP.A-093	19,8			
Toledo II (1M2) 1.8 20V T	05/01-05/06	ATE	TP.A-092/ TP.A-093	19,8			
Toledo II (1M2) 1.9 SDI	11/99-06/04	ATE	TP.A-092/ TP.A-093	19,8			
Toledo II (1M2) 1.9 TDI	04/99-05/06	ATE	TP.A-092/ TP.A-093	19,8			
Toledo II (1M2) 2.3 V5	04/99-05/01	ATE	TP.A-092/ TP.A-093	19,8			
Toledo II (1M2) 2.3 V5 20V	05/01-05/06	ATE	TP.A-092/ TP.A-093	19,8			

Марка автомобиля	Годы выпуска автомобиля	Передние колодки			Задние колодки		
		Тип тормозной системы	№ по каталогу	Толщина изделия, мм	Тип тормозной системы	№ по каталогу	Толщина изделия, мм
SKODA							
Citigo 1,0 (CHYB / CHYA)	10/11 –	ATE	TP.A-065	19,8			
Fabia 1.2	12/06-	ATE	TP.A-092/ TP.A-093	19,8			
Fabia 1,2 12V	11/11 –	ATE	TP.A-065 TP.A-092 TP.A-093	19,8			
Fabia 1,2 TDI	05/10 –	ATE	TP.A-065	19,8			
Fabia 1,2 TSI	03/10 –	ATE	TP.A-065 TP.A-092 TP.A-093	19,8			
Fabia 1.4	01/07-	ATE	TP.A-092/ TP.A-093	19,8			
Fabia 1.4 TDI	01/07-	ATE	TP.A-092/ TP.A-093	19,8			
Fabia 1.6	04/07-	ATE	TP.A-092/ TP.A-093	19,8			
Fabia 1,6 TDI	03/10 –	ATE	TP.A-065 TP.A-092 TP.A-093	19,8			
Fabia 1.9 TDI	04/07-	ATE	TP.A-092/ TP.A-093	19,8			
Fabia (6Y2) 1.2	08/02-03/08	ATE	TP.A-092/ TP.A-093	19,8			
Fabia (6Y2) 1.4	08/99-03/08	ATE	TP.A-092/ TP.A-093	19,8			
Fabia (6Y2) 1.4 16V	12/99-03/08	ATE	TP.A-092/ TP.A-093	19,8			
Fabia (6Y2) 1.4	-04/04	ATE	TP.A-092/ TP.A-093	19,8			
Fabia (6Y2) 1.4 TDI Ø256,0 mm	04/03-03/08	ATE	TP.A-092/ TP.A-093	19,8			
Fabia (6Y2) 1.4 TDI Ø288,0 mm	04/03-03/08	ATE	TP.A-092/ TP.A-093	19,8			
Fabia (6Y2) 1.4 TDI Ø295,5 mm	04/03-03/08	ATE	TP.A-092/ TP.A-093	19,8			
Fabia (6Y2) 1.9 SDI	12/99-03/08	ATE	TP.A-092/ TP.A-093	19,8			
Fabia (6Y2) 1.9 TDI	01/00-03/08	ATE	TP.A-092/ TP.A-093	19,8			
Fabia Box 1.2	07/01-07/05	ATE	TP.A-092/ TP.A-093	19,8			
Fabia Box 1.4	07/01-07/05	ATE	TP.A-092/ TP.A-093	19,8			
Fabia Box 1.4 TDI	10/05-12/07	ATE	TP.A-092/ TP.A-093	19,8			
Fabia Box 1.9 TDI	07/01-12/07	ATE	TP.A-092/ TP.A-093	19,8			
Fabia Combi 1,2	10/07 –	ATE	TP.A-065 TP.A-092 TP.A-093	19,8			

Марка автомобиля	Годы выпуска автомобиля	Передние колодки			Задние колодки		
		Тип тормозной системы	№ по каталогу	Толщина изделия, мм	Тип тормозной системы	№ по каталогу	Толщина изделия, мм
SKODA							
Fabia Combi 1,2 12V	11/11 –	ATE	TP.A-065 TP.A-092 TP.A-093	19,8			
Fabia Combi 1,2 TDI / TSI	03/10 –	ATE	TP.A-065 TP.A-092 TP.A-093	19,8			
Fabia Combi 1,4 TDI	10/07 –	ATE	TP.A-065 TP.A-092 TP.A-093	19,8			
Fabia Combi 1,6	10/07 –	ATE	TP.A-065 TP.A-092 TP.A-093	19,8			
Fabia Combi 1,6 TDI	03/10 –	ATE	TP.A-065 TP.A-092 TP.A-093	19,8			
Fabia Combi 1,9 TDI	10/07 –	ATE	TP.A-065 TP.A-092 TP.A-093	19,8			
Fabia Combi (6Y5) 1,2	07/01 – 12/07	ATE	TP.A-092 TP.A-093	19,8			
Fabia Combi (6Y5) 1,4	04/00 – 05/03	ATE	TP.A-092 TP.A-093	19,8			
Fabia Combi (6Y5) 1,4 16V	04/00 – 12/07	ATE	TP.A-065 TP.A-092 TP.A-093	19,8			
Fabia Combi (6Y5) 1,4 TDI	04/03 – 12/07	ATE	TP.A-092 TP.A-093	19,8			
Fabia Combi (6Y5) 1,9 SDI / TDI	04/00 – 12/07	ATE	TP.A-065 TP.A-092 TP.A-093	19,8			
Fabia Estate 1,2	10/07-	ATE	TP.A-092/ TP.A-093	19,8			
Fabia Estate 1,4	10/07-	ATE	TP.A-092/ TP.A-093	19,8			
Fabia Estate (6J5) 1,2	07/01-12/07	ATE	TP.A-092/ TP.A-093	19,8			
Fabia Estate (6J5) 1,4	04/00-12/07	ATE	TP.A-092/ TP.A-093	19,8			
Fabia Estate (6J5) 1,4 16V	04/00-12/07	ATE	TP.A-092/ TP.A-093	19,8			
Fabia Estate (6J5) 1,4 TDI	04/03-12/07	ATE	TP.A-092/ TP.A-093	19,8			
Fabia Estate (6J5) 1,9 SDI	04/00-12/07	ATE	TP.A-092/ TP.A-093	19,8			
Fabia Estate (6J5) 1,9 TDI	04/00-12/07	ATE	TP.A-092/ TP.A-093	19,8			
Fabia Praktik 1,2	01/03 – 12/07	ATE	TP.A-065 TP.A-092 TP.A-093	19,8			
Fabia Praktik 1,4	07/01 – 05/03	ATE	TP.A-065 TP.A-092 TP.A-093	19,8			

Марка автомобиля	Годы выпуска автомобиля	Передние колодки			Задние колодки		
		Тип тормозной системы	№ по каталогу	Толщина изделия, мм	Тип тормозной системы	№ по каталогу	Толщина изделия, мм
SKODA							
Fabia Praktik 1,4 TDI	10/05 – 12/07	ATE	TP.A-065 TP.A-092 TP.A-093	19,8			
Fabia Praktik 1,9 SDI	07/01 – 12/07	ATE	TP.A-065 TP.A-092 TP.A-093	19,8			
Fabia Saloon (6J3) 1.2	07/01-12/07	ATE	TP.A-092/ TP.A-093	19,8			
Fabia Saloon (6J3) 1.4 (04/00-12/07)	-04/04	ATE	TP.A-092/ TP.A-093	19,8			
Fabia Saloon (6J3) 1.4 16V	10/99-12/07	ATE	TP.A-092/ TP.A-093	19,8			
Fabia Saloon (6J3) 1.4 TDI	04/03-12/07	ATE	TP.A-092/ TP.A-093	19,8			
Fabia Saloon (6J3) 1,9 SDI / TDI	11/99 – 12/07	ATE	TP.A-065 TP.A-092 TP.A-093	19,8			
Favorit 1,1	89-	GIR	TP.A 013	17,5			
Favorit 1,1 L	89-	GIR	TP.A 013	17,5			
Favorit 1,1 Practic (Van)	90-	GIR	TP.A 013	17,5			
Favorit 1,3 136 L / 135 S	88-	GIR	TP.A 013	17,5			
Favorit 1,3 Forum, GLX, GLXi, L, LE, LS, LX	89-	GIR	TP.A 013	17,5			
Favorit 1,3 GLXi Blackline, GLXi Silverline	93-	GIR	TP.A 013	17,5			
Favorit 1,3 L (136)	89-	GIR	TP.A 013	17,5			
Favorit 1,3 L Decatop	90-	GIR	TP.A 013	17,5			
Favorit 1,3 LS (136)	90-	GIR	TP.A 013	17,5			
Favorit 1,3 LS Ecotronic, Excelent, S	93-	GIR	TP.A 013	17,5			
Favorit 1,3 Practic 137 L	90-	GIR	TP.A 013	17,5			
Favorit 1,3 SL, Sport Line, LXi	93-	GIR	TP.A 013	17,5			
Favorit 1,3 LX Van Plus, LXi Van Plus	93-	GIR	TP.A 013	17,5			
Favorit 1,3 LX Van, LXi Van	93-	GIR	TP.A 013	17,5			
Favorit Foreman 1,3 all models	93-	GIR	TP.A 013	17,5			
Favorit Freeway 1,3 all models	93-	GIR	TP.A 013	17,5			
Favorit (781) 1.3	01/94-09/94	TRW	TP.A-102	17,5			
Favorit (781) 1.3 135	10/90-09/94	TRW	TP.A-102	17,5			
Favorit (781) 1.3 135 X, LX, GLX	01/90-09/94	TRW	TP.A-102	17,5			
Favorit (781) 1.3 135 L	05/89-09/94	TRW	TP.A-102	17,5			
Favorit Estate (785) 1.3	08/91-06/95	TRW	TP.A-102	17,5			
Favorit Forman (785) 1,3 (135 E)	09/91 – 06/95	GIR TRW	TP.A-013 TP.A-102	17,5			
Favorit Forman (785) 1,3 (135, 136)	08/91 – 06/95	GIR TRW	TP.A-013 TP.A-102	17,5			
Favorit Pickup (787) 1.3	06/92-06/97	TRW	TP.A-102	17,5			

Марка автомобиля	Годы выпуска автомобиля	Передние колодки			Задние колодки		
		Тип тормозной системы	№ по каталогу	Толщина изделия, мм	Тип тормозной системы	№ по каталогу	Толщина изделия, мм
SKODA							
Felicia 1,3 LXi	94-	GIR	TP.A 013	17,5			
Felicia 1,3 LXi Plus, GLX	94-	GIR	TP.A 013	17,5			
Felicia 1,6 all models	96-	GIR	TP.A 013	17,5			
Felicia Combi 1,3	96-	GIR	TP.A 013	17,5			
Felicia Combi 1,9 D	96-	GIR	TP.A 013	17,5			
Felicia Combi 1,9 D	96-	GIR	TP.A 019	19,5			
Felicia I (6U1) 1.3	10/94-03/98	TRW	TP.A-102	17,5			
Felicia I (6U1) 1.6 LX	08/95-03/98	TRW	TP.A-102	17,5			
Felicia I (6U1) 1.9 D	10/95-03/98	TRW	TP.A-102	17,5			
Felicia I Estate (6U5) 1.3	08/95-03/98	TRW	TP.A-102	17,5			
Felicia I Estate (6U5) 1.3 LX	08/95-03/98	TRW	TP.A-102	17,5			
Felicia I Estate (6U5) 1.3 LXI	08/95-03/98	TRW	TP.A-102	17,5			
Felicia I Estate (6U5) 1.6 GLX	08/95-03/98	TRW	TP.A-102	17,5			
Felicia I Estate (6U5) 1.9 D	10/95-03/98	TRW	TP.A-102	17,5			
Felicia I Pickup (797) (10/95-) 1.3	10/95-	TRW	TP.A-102	17,5			
Felicia I Pickup 797 (10/95-) 1.6	06/97-	TRW	TP.A-102	17,5			
Felicia I Pickup 797 1.9 D	06/97-	TRW	TP.A-102	17,5			
Felicia II (6U1) 1.3	01/98-06/01	TRW	TP.A-102	17,5			
Felicia II (6U1) 1.6	01/98-06/01	TRW	TP.A-102	17,5			
Felicia II (6U1) 1.9 D	01/98-06/01	TRW	TP.A-102	17,5			
Felicia II Estate (6U5) 1,3	01/98 – 06/01	TRW	TP.A-102	17,5			
Felicia II Estate (6U5) 1,6	01/98 – 06/01	TRW	TP.A-102	17,5			
Felicia II Estate (6U5) 1,9 D	01/98 – 06/01	TRW	TP.A-102	17,5			
Forman 1,3	91-	GIR	TP.A 013	17,5			
Forman Estate (785) 1,3 (135 E)	09/91 – 06/95	GIR TRW	TP.A-013 TP.A-102	17,5			
Forman Estate (785) 1,3 (135, 136)	08/91 – 06/95	GIR TRW	TP.A-013 TP.A-102	17,5			
Laura (1Z3) 1,2 TSI	02/10 –	ATE	TP.A-093	19,8			
Laura (1Z3) 1,4	05/04 –	ATE	TP.A-093	19,8			
Laura (1Z3) 1,4 TSI	11/08 –	ATE	TP.A-093	19,8			
Laura (1Z3) 1,6	06/04 –	ATE	TP.A-093	19,8			
Laura (1Z3) 1,6 FSI	02/04 – 10/08	ATE	TP.A-093	19,8			
Laura (1Z3) 1,6 LPG	08/09 –	ATE	TP.A-093	19,8			
Laura (1Z3) 1,6 Multi Fuel	01/08 –	ATE	TP.A-093	19,8			
Laura (1Z3) 1,6 TDI	06/09 –	ATE	TP.A-093	19,8			
Laura (1Z3) 1,9 TDI	06/04 – 12/10	ATE	TP.A-093	19,8			
Laura (1Z3) 2,0 FSI	11/04 –	ATE	TP.A-093	19,8			

Марка автомобиля	Годы выпуска автомобиля	Передние колодки			Задние колодки		
		Тип тормозной системы	№ по каталогу	Толщина изделия, мм	Тип тормозной системы	№ по каталогу	Толщина изделия, мм
SKODA							
Octavia (A4) 1,6	96-	ATE	TP.A-065	19,8	GIR	TP.A 014	15,0
Octavia (A4) 1,6 16V	97-	ATE	TP.A-065	19,8	GIR	TP.A 014	15,0
Octavia (A4) 1,8 20V	96-	ATE	TP.A-065	19,8	GIR	TP.A 014	15,0
Octavia (A4) 1,9 SDi	97-	ATE	TP.A-065	19,8	GIR	TP.A 014	15,0
Octavia (A4) 1,9 TDi	97-	ATE	TP.A-065	19,8	GIR	TP.A 014	15,0
Octavia (A4) 2,8 VR6	96-	ATE	TP.A-065	19,8	GIR	TP.A 014	15,0
Octavia (1Z3) 1.4	05/04-	ATE	TP.A-092/ TP.A-093	19,8			
Octavia (1Z3) 1.6	06/04-	ATE	TP.A-092/ TP.A-093	19,8			
Octavia (1Z3) 1.6 FSI	02/04-	ATE	TP.A-092/ TP.A-093	19,8			
Octavia (1Z3) 1.6 Green Line	01/08-	ATE	TP.A-092/ TP.A-093	19,8			
Octavia (1Z3) 1.8 TSI	06/07-	ATE	TP.A-092/ TP.A-093	19,8			
Octavia (1Z3) 1.9 TDI	06/04-	ATE	TP.A-092/ TP.A-093	19,8			
Octavia (1Z3) 2.0 FSI	11/04-	ATE	TP.A-092/ TP.A-093	19,8			
Octavia (1Z3) 2.0 TDI	02/04-	ATE	TP.A-092/ TP.A-093	19,8			
Octavia (1Z3) 2.0 TDI 16V	02/04-	ATE	TP.A-092/ TP.A-093	19,8			
Octavia (1U2) (09/96-) 1.8 Ø256,0 mm	09/06-	ATE	TP.A-092/ TP.A-093	19,8			
Octavia (1U2) (09/96-) 1.8 Ø280 mm	09/06-	ATE	TP.A-092/ TP.A-093	19,8			
Octavia (1U2) (09/96-) 1.8 Ø256 mm	-07/00	ATE	TP.A-092/ TP.A-093	19,8			
Octavia (1U2) (09/96-) 1.9 DI	-04/99	ATE	TP.A-092/ TP.A-093	19,8			
Octavia (1U2) (09/96-) 1.9 TDI Ø256 mm	-04/99	ATE	TP.A-092/ TP.A-093	19,8			
Octavia (1U2) (09/96-) 1.9 TDI Ø280,0 mm	-04/99	ATE	TP.A-092/ TP.A-093	19,8			
Octavia (1U2) (09/96-) 1.9 TDI	-07/00	ATE	TP.A-092/ TP.A-093	19,8			
Octavia (1U2) (09/96-) 2.0 Ø256,0 mm	-07/00	ATE	TP.A-092/ TP.A-093	19,8			
Octavia (1U2) (09/96-) 2.0 Ø280,0 mm	-07/00	ATE	TP.A-092/ TP.A-093	19,8			
Octavia (1U2) 1,4	04/99 – 03/01	ATE	TP.A-092 TP.A-093	19,8			
Octavia (1U2) 1,4 16V	09/00 – 12/10	ATE	TP.A-093	19,8			
Octavia (1U2) 1,6	09/96 – 12/10	ATE	TP.A-065 TP.A-092 TP.A-093	19,8			
Octavia (1U2) 1,8 T	08/97 – 12/10	ATE	TP.A-093	19,8			
Octavia (1U2) 1,8 T 4x4	05/01 – 05/06	ATE	TP.A-093	19,8			

Марка автомобиля	Годы выпуска автомобиля	Передние колодки			Задние колодки		
		Тип тормозной системы	№ по каталогу	Толщина изделия, мм	Тип тормозной системы	№ по каталогу	Толщина изделия, мм
SKODA							
Octavia (1U2) 1,9 SDI	06/97 – 12/03	ATE	TP.A-065 TP.A-092 TP.A-093	19,8			
Octavia Estate (1Z5) (02/04-) 1.6	09/04-	ATE	TP.A-092/ TP.A-093	19,8			
Octavia Estate (1Z5) (02/04-) 1.6 FSI	02/04-	ATE	TP.A-092/ TP.A-093	19,8			
Octavia Estate (1Z5) (02/04-) 1.6 Multifuel	01/08-	ATE	TP.A-092/ TP.A-093	19,8			
Octavia Estate (1Z5) 1.8 TSI (02/04-)	06/07-	ATE	TP.A-092/ TP.A-093	19,8			
Octavia Estate (1Z5) (02/04-) 1.9 TDI	09/04-	ATE	TP.A-092/ TP.A-093	19,8			
Octavia Estate (1Z5) (02/04-) 1.9 TDI 4x4	11/04-	ATE	TP.A-092/ TP.A-093	19,8			
Octavia Estate (1Z5) (02/04-) 2.0 FSI	11/04-	ATE	TP.A-092/ TP.A-093	19,8			
Octavia Estate (1Z5) (02/04-) FSI 4x4	11/04-	ATE	TP.A-092/ TP.A-093	19,8			
Octavia Estate (1Z5) (02/04-) TDI	11/05-	ATE	TP.A-092/ TP.A-093	19,8			
Octavia Estate (1Z5) (02/04-) TDI 16V	02/04-	ATE	TP.A-092/ TP.A-093	19,8			
Octavia Estate (1Z5) (02/04-) TDI 16V	02/04-	ATE	TP.A-092/ TP.A-093	19,8			
Octavia Estate (1Z5) (02/04-) TDI 4x4	07/06-	ATE	TP.A-092/ TP.A-093	19,8			
Octavia Estate (1U5) (07/98-) 1.6	-07/00	ATE	TP.A-092/ TP.A-093	19,8			
Octavia Estate (1U5) (07/98-) 1.6	08/00-	ATE	TP.A-092/ TP.A-093	19,8			
Octavia Estate (1U5) (07/98-) 1.6	08/00-	ATE	TP.A-092/ TP.A-093	19,8			
Octavia Estate (1U5) (07/98-) 1.8 20V Ø256,0 mm	07/98-	ATE	TP.A-092/ TP.A-093	19,8			
Octavia Estate (1U5) (07/98-) 1.8 20V Ø280,0 mm	07/98-	ATE	TP.A-092/ TP.A-093	19,8			
Octavia Estate (1U5) (07/98-) 1.8 T 07/98- Ø256 mm	07/00-	ATE	TP.A-092/ TP.A-093	19,8			
Octavia Estate (1U5) (07/98-) 1.8 T Ø280 mm	-07/00	ATE	TP.A-092/ TP.A-093	19,8			
Octavia Estate (1U5) (07/98-) 1.9 SDI	-04/99	ATE	TP.A-092/ TP.A-093	19,8			
Octavia Estate (1U5) (07/98-) 1.9 TDI Ø256,0 mm	-07/00	ATE	TP.A-092/ TP.A-093	19,8			
Octavia Estate (1U5) (07/98-) 1.9 TDI Ø280,0 mm	-07/00	ATE	TP.A-092/ TP.A-093	19,8			
Octavia Estate (1Z5) 1.4	10/06-	ATE	TP.A-092/ TP.A-093	19,8			
Octavia Estate (1Z5) 1.6	09/04-	ATE	TP.A-092/ TP.A-093	19,8			
Octavia Estate (1Z5) 1.6 FSI	02/04-	ATE	TP.A-092/ TP.A-093	19,8			

Марка автомобиля	Годы выпуска автомобиля	Передние колодки			Задние колодки		
		Тип тормозной системы	№ по каталогу	Толщина изделия, мм	Тип тормозной системы	№ по каталогу	Толщина изделия, мм
SKODA							
Octavia Estate (1Z5) 1.6 Multifuel	01/08-	ATE	TP.A-092/ TP.A-093	19,8			
Octavia Estate (1Z5) 1.9 TDI 4x4	11/04-	ATE	TP.A-092/ TP.A-093	19,8			
Octavia Estate (1Z5) 2.0 FSI	11/04-	ATE	TP.A-092/ TP.A-093	19,8			
Octavia Estate (1Z5) 2.0 4x4	11/04-	ATE	TP.A-092/ TP.A-093	19,8			
Octavia Estate (1Z5) 2.0 RS	10/05-	ATE	TP.A-092/ TP.A-093	19,8			
Octavia Estate (1Z5) 2.0 TDI	11/05-	ATE	TP.A-092/ TP.A-093	19,8			
Octavia Estate (1Z5) 2.0 TDI 16V	02/04-	ATE	TP.A-092/ TP.A-093	19,8			
Octavia Estate (1Z5) 2.0 TDI 4x4	07/06-	ATE	TP.A-092/ TP.A-093	19,8			
Octavia Estate (1U5) 1,4 16V	08/00 – 12/10	ATE	TP.A-093	19,8			
Octavia Estate (1U5) 1,8 T 4x4	05/01 – 05/06	ATE	TP.A-093	19,8			
Octavia Estate (1U5) 1,9 TDI 4x4	11/99 – 02/06	ATE	TP.A-065 TP.A-092 TP.A-093	19,8			
Octavia Estate (1U5) 2,0	04/99 – 05/07	ATE	TP.A-065 TP.A-092 TP.A-093	19,8			
Octavia Estate (1Z5) 1,2 TSI	02/10 –	ATE	TP.A-093	19,8			
Octavia Estate (1Z5) 1,4 TSI	11/08 –	ATE	TP.A-093	19,8			
Octavia Estate (1Z5) 1,6 LPG	08/09 –	ATE	TP.A-093	19,8			
Octavia Estate (1Z5) 1,6 TDI (4x4)	06/09 –	ATE	TP.A-093	19,8			
Praktik (5J) 1,2	05/06 –	ATE	TP.A-065 TP.A-092 TP.A-093	19,8			
Praktik (5J) 1,2 TDI / TSI	03/10 –	ATE	TP.A-065 TP.A-092 TP.A-093	19,8			
Praktik (5J) 1,4 TDI	09/06 –	ATE	TP.A-065 TP.A-092 TP.A-093	19,8			
Praktik (5J) 1,6	09/06 –	ATE	TP.A-065 TP.A-092 TP.A-093	19,8			
Praktik (5J) 1,6 TDI	03/10 –	ATE	TP.A-065	19,8			
Praktik (5J) 1,9 TDI	03/06 – 03/10	ATE	TP.A-065 TP.A-092 TP.A-093	19,8			
Rapid 1,2 TSI	07/12 –	ATE	TP.A-065	19,8			
Rapid 1,4 TSI	07/12 –	ATE	TP.A-065	19,8			
Rapid 1,6 TDI	07/12 –	ATE	TP.A-065	19,8			
Roomster (5J) 1,2 TDI / TSI	03/10 –	ATE	TP.A-065 TP.A-092 TP.A-093	19,8			

Марка автомобиля	Годы выпуска автомобиля	Передние колодки			Задние колодки		
		Тип тормозной системы	№ по каталогу	Толщина изделия, мм	Тип тормозной системы	№ по каталогу	Толщина изделия, мм
SKODA							
Roomster Praktik (5J) 1,2	03/07 –	ATE	TP.A-065 TP.A-092 TP.A-093	19,8			
Roomster Praktik (5J) 1,2 TDI / TSI	03/10 –	ATE	TP.A-065	19,8			
Roomster Praktik (5J) 1,4 TDI	03/07 –	ATE	TP.A-065 TP.A-092 TP.A-093	19,8			
Roomster Praktik (5J) 1,6 TDI	03/10 –	ATE	TP.A-065	19,8			
Roomster (5J) (05/06-) 1.2; 14"	05/06-	ATE	TP.A-092/ TP.A-093	19,8			
Roomster (5J) (05/06-) 1.2; 14"	09/06-	ATE	TP.A-092/ TP.A-093	19,8			
Roomster (5J) (05/06-) 1.4 TDI; 14"	07/06-	ATE	TP.A-092/ TP.A-093	19,8			
Roomster (5J) (05/06-) 1.6; 14"	09/06-	ATE	TP.A-092/ TP.A-093	19,8			
Roomster (5J) (05/06-) 1.9 TDI; 14"	09/06-	ATE	TP.A-092/ TP.A-093	19,8			
SOLARIS							
Alpino (250 л.с.)	2007 –	KNORR SB 7000	TP.A-115	30,0	KNORR SB 7000	TP.A-115	30,0
Urbino (155, 220, 249, 260, 310, 320, 350 л.с.)	1999 –	KNORR SB 7000	TP.A-115	30,0	KNORR SB 7000	TP.A-115	30,0
Urbino (250 л.с.)	2002 –	KNORR SB 7000	TP.A-115	30,0	KNORR SB 7000	TP.A-115	30,0
Urbino (340, 360 л.с.)	2006 –	KNORR SB 7000	TP.A-115	30,0	KNORR SB 7000	TP.A-115	30,0
Vacanza (340, 381 л.с.)	2002 – 2006	KNORR SB 7000	TP.A-115	30,0	KNORR SB 7000	TP.A-115	30,0
Vacanza (408 л.с.)	2005 –	KNORR SB 7000	TP.A-115	30,0	KNORR SB 7000	TP.A-115	30,0
Vacanza (428 л.с.)	2003 – 2006	KNORR SB 7000	TP.A-115	30,0	KNORR SB 7000	TP.A-115	30,0
SUBARU							
E 10 1,0 Van 4WD	86-	SUM	TP.A 004	15,5			
E 12 1,2 Van 4WD	88-	SUM	TP.A 004	15,5			
Justi 1,0 2WD DL / GL / S	83-	SUM	TP.A 004	15,5			
Justi 1,0 2WD SII / GLII E CVT	88-	SUM	TP.A 004	15,5			
Justi 1,0 4WD GLII	88-	SUM	TP.A 004	15,5			
Justi 1,2 WDSII / GLII	86-	SUM	TP.A 004	15,5			
Justi 1,2 4WD GLII ECVT	88-	SUM	TP.A 004	15,5			
Justi 1,2 4WD SII / GLII	86-88	SUM	TP.A 004	15,5			
Justi 1,2 SII / GLII ECVT Auto	88-	SUM	TP.A 004	15,5			
Libero 1,2 4WD Van	89-	SUM	TP.A 004	15,5			
Libero Bus (E12, KJ8) 1,2 4WD	08/86 – 02/00	SUM	TP.A-004	15,5			
Mini Jumbo 0,7 DL / SDX (5 Doors)	82-88	SUM	TP.A 004	15,5			

Марка автомобиля	Годы выпуска автомобиля	Передние колодки			Задние колодки		
		Тип тормозной системы	№ по каталогу	Толщина изделия, мм	Тип тормозной системы	№ по каталогу	Толщина изделия, мм
SUBARU							
Mini Jumbo Van 0,7 700 (S)	84-86	SUM	TP.A 004	15,5			
Sumo Bus (E12, KJ8) 1,2 4WD	08/86 – 02/00	SUM	TP.A-004	15,5			
Vanille Bus (E12, KJ8) 1,2 4WD	08/86 – 02/00	SUM	TP.A-004	15,5			
TALBOT							
1100 Ti	73-74	ATE	TP.A 001	15,0			
1300 1,3 GL	65-72	ATE	TP.A 001	15,0			
1300, 1301, 1301 S	67-76	ATE	TP.A 001	15,0			
1301 1,3 Break / HL / GL, S	65-72	ATE	TP.A 001	15,0			
1301 1,3 S / Special	72-75	ATE	TP.A 001	15,0			
1307, 1308, 1309	75-79	ATE	TP.A 033	15,0			
1500 1,5 Break	65-72	ATE	TP.A 001	15,0			
1500, 1501, 1501 S	65-76	ATE	TP.A 001	15,0			
1501 1,5 Break S / GL / GLS	72-75	ATE	TP.A 001	15,0			
1510 1,3 LS / GL / GLS	79-82	ATE	TP.A 033	15,0			
1510 1,4 LS / GL / GLS	79-82	ATE	TP.A 033	15,0			
1510 1,6 SX / T3 113 / 213	79-82	ATE	TP.A 033	15,0			
1510 Solara	79-80	ATE	TP.A 033	15,0			
1609 1,6 GLX / SX	78-81	ATE	TP.A 033	15,0			
Alpine all models	75-80	ATE	TP.A 033	15,0			
Horison all models	78-85	ATE	TP.A 001	15,0			
Matra Bagheera all models	73-87	ATE	TP.A 001	15,0			
Rally 2, Rally 3	72-79	ATE	TP.A 001	15,0			
Rancho all models	78-83	ATE	TP.A 001	15,0			
Simca 1000 Rally 2/3	73-78	ATE	TP.A 001	15,0			
TOYOTA							
Altis Sedan (Axio) (_E12J_, _E12T_) 1,4 D-4D	07/04 – 07/07	TRW	TP.A-098	17,8			
Altis Sedan (Axio) (_E12J_, _E12T_) 1,4 VVT-I	08/02 – 07/07	TRW	TP.A-098	17,8			
Altis Sedan (Axio) (_E12J_, _E12T_) 1,6 VVT-I	08/02 – 07/07	TRW	TP.A-098	17,8			
Altis Sedan (Axio) (_E12J_, _E12T_) 2,0 D-4D	08/02 – 07/07	TRW	TP.A-098	17,8			
Bandeirante 2,4 (RJ70_, RJ73_)	11/84 – 12/96	SUM	TP.A-045	15,0			
Bandeirante 2,4 TD (LJ70)	01/90 – 05/93	SUM	TP.A-045	15,0			
Bandeirante 3,0 TD (KZJ70_, KZJ73_, KZJ77_)	05/93 – 05/96	SUM	TP.A-045	15,0			
Bandeirante 3,4 D (BJ70_V, BJ73_)	11/84 – 12/96	SUM	TP.A-045	15,0			

Марка автомобиля	Годы выпуска автомобиля	Передние колодки			Задние колодки		
		Тип тормозной системы	№ по каталогу	Толщина изделия, мм	Тип тормозной системы	№ по каталогу	Толщина изделия, мм
TOYOTA							
Bandeirante 4,2 TD (HZJ7__V)	01/90 –	SUM	TP.A-045	15,0			
Caldina 1,8 ST 190 G	92-	SUM	TP.A-068	17,5			
Caldina 2,0 CT 190 G	92-	SUM	TP.A-068	17,5			
Caldina 2,0 ST 191 G	92-	SUM	TP.A-068	17,5			
Caldina 2,0 ST 195 G	92-	SUM	TP.A-068	17,5			
Caldina 2,0 ST 202 G TZ-G	95-	SUM	TP.A-068	17,5			
Camry 1,8 all models	82-88	AKB	TP.A 005	15,0			
Camry 1,8 D DX, Turbo DX, GL	83-85	AKB	TP.A 005	15,0			
Camry 2,0i 16V GLi, GLi	83-91	AKB	TP.A 005	15,0			
Camry 2,0 D GL, Turbo DX, GL	85-88	AKB	TP.A 005	15,0			
Camry 2,5 V6 GXi	02/88-05/91	AKB	TP.A 005	15,0			
Camry (V 10) 2,2 GL	91-96	SUM	TP.A-068	17,5			
Camry (V 10) 2,2 GL Stationwagon	91-96	SUM	TP.A-068	17,5			
Camry 1,8 Turbo Diesel (SV 11)	86-87	AKB	TP.A 005	15,0			
Camry 1,8 DX Liftback	85-87	AKB	TP.A 005	15,0			
Camry 2,0 Liftback (V 1)	04/86-01/88	AKB	TP.A 005	15,0			
Camry Vista 1,9 SV40	94-	SUM	TP.A-068	17,5			
Camry Vista 2,0 CV40	94-	SUM	TP.A-068	17,5			
Camry Vista 2,0 CV40 (R DISC)	94-	SUM	TP.A-068	17,5			
Camry Vista 2,0 SV41	94-	SUM	TP.A-068	17,5			
Camry Vista 2,0 SV42	94-	SUM	TP.A-068	17,5			
Camry Vista 2,0 SV43	94-	SUM	TP.A-068	17,5			
Camry 2,2 (_CV2_, _XV2_)	08/96 – 11/01	SUM	TP.A-068	17,5			
Camry Sedan 2,0 (SV21_, SV25_)	11/86 – 05/91	AKB	TP.A-005	15,0			
Camry Sedan 2,0 Gli 16V (SV21_, SV25_)	11/86 – 05/91	AKB	TP.A-005	15,0			
Camry Sedan 2,2 (SXV10, SXV20_)	06/91 – 11/01	SUM	TP.A-068	17,5			
Camry Sedan 2,5 V6 GXI (VZV21_)	02/88 – 05/91	AKB	TP.A-005	15,0			
Camry Station Wagon 1,8 (SV20_)	11/86 – 08/88	AKB	TP.A-005	15,0			
Camry Station Wagon 2,0 (SV21_)	11/86 – 05/91	AKB	TP.A-005	15,0			
Camry Station Wagon 2,0 GLi 16V (SV21_)	11/86 – 05/91	AKB	TP.A-005	15,0			
Carina 1,6 DL, DX, GL	83-87	AKB	TP.A 005	15,0			
Carina 1,6 AA 63	83-85	SUM	TP.A-035	15,5			
Carina 1,8 TA 63	82-85	SUM	TP.A-035	15,5			
Carina II 1,6 DL / DX / GL	83-88	AKB	TP.A 005	15,0			
Carina II 1,6 GL Liftback	83-88	AKB	TP.A 005	15,0			
Carina II 1,6 GLi Twin Cam	88-	AKB	TP.A 005	15,0			
Carina II 1,6 Twin Cam 16V	89-	AKB	TP.A 005	15,0			
Carina II 1,6 Wagon, XL 13" Wheels	88-	AKB	TP.A 005	15,0			
Carina II 1,6 DL 13" Wheels	88-	AKB	TP.A 005	15,0			
Carina II 1,6i, TLi 16V MM	88-	AKB	TP.A 005	15,0			
Carina 1,8 GL, GLi	83-87	AKB	TP.A 005	15,0			

Марка автомобиля	Годы выпуска автомобиля	Передние колодки			Задние колодки		
		Тип тормозной системы	№ по каталогу	Толщина изделия, мм	Тип тормозной системы	№ по каталогу	Толщина изделия, мм
TOYOTA							
Carina II 1,8i GL, GLi	83-91	AKB	TP.A 005	15,0			
Carina 2,0 D all models	83-87	AKB	TP.A 005	15,0			
Carina II 2,0 DX (CT 150)	83-88	AKB	TP.A 005	15,0			
Carina II 2,0 DX Liftback	83-88	AKB	TP.A 005	15,0			
Carina II 2,0 Diesel 13" Wheels	88-	AKB	TP.A 005	15,0			
Carina II 2,0 GLi TC Automatic	88-	AKB	TP.A 005	15,0			
Carina II 2,0 Wagon 13" Wheels	88-	AKB	TP.A 005	15,0			
Carina II 2,0i GLi 13" Wheels	88-	AKB	TP.A 005	15,0			
Carina II Sedan (T17) 1,6 (AT171)	12/87 – 03/92	AKB	TP.A-005	15,0			
Carina II Sedan (T17) 2,0 D	03/88 – 06/92	AKB	TP.A-005	15,0			
Carina E (ST 191) 1,6 All models	92-96	SUM	TP.A-068	17,5			
Carina E (T 19) 1,6 Notchback	92-	SUM	TP.A-068	17,5			
Carina E (ST 191) 1,8 Liftback	95-	SUM	TP.A-068	17,5			
Carina E (T 19) 1,8 Notchback	95-	SUM	TP.A-068	17,5			
Carina E (ST 191) 2,0 All models	92-96	SUM	TP.A-068	17,5			
Carina E (T 19) 2,0i Notchback	92-	SUM	TP.A-068	17,5			
Carina E (ST 191) 2,0 Diesel	94-	SUM	TP.A-068	17,5			
Carina E (T 19) 2,0 Diesel Notchback	94-	SUM	TP.A-068	17,5			
Carina E (AT190) 1,6	12/93 – 09/97	SUM	TP.A-068	17,5			
Carina E (AT190) 1,6 16V (GLI)	10/95 – 09/97	SUM	TP.A-068	17,5			
Carina E (AT191) 1,8	01/95 – 09/97	SUM	TP.A-068	17,5			
Carina E (CT190) 2,0 D / TD	04/92 – 09/97	SUM	TP.A-068	17,5			
Carina E (ST191) 2,0 GLI (GTi 16V)	04/92 – 09/97	SUM	TP.A-068	17,5			
Carina E (ST191) 2,0i	12/93 – 09/97	SUM	TP.A-068	17,5			
Carina E Sedan (AT190) 1,6	01/93 – 09/97	SUM	TP.A-068	17,5			
Carina E Sedan (AT190) 1,6 16V	12/94 – 09/97	SUM	TP.A-068	17,5			
Carina E Sedan (AT191) 1,8i 16V	01/95 – 09/97	SUM	TP.A-068	17,5			
Carina E Sedan (ST191) 2,0	01/93 – 09/97	SUM	TP.A-068	17,5			
Carina E Sedan (CT190) 2,0 D / TD	08/92 – 09/97	SUM	TP.A-068	17,5			
Carina E Sedan (ST191) 2,0i (GTi, GTi 16V)	12/92 – 09/97	SUM	TP.A-068	17,5			
Carina E Sportswagon (AT190) 1,6i (GLI)	01/93 – 09/97	SUM	TP.A-068	17,5			
Carina E Sportswagon (AT191) 1,8i	02/95 – 09/97	SUM	TP.A-068	17,5			
Carina E Sportswagon (CT190) 2,0 D / TD	01/93 – 01/96	SUM	TP.A-068	17,5			
Carina E Sportswagon (ST191) 2,0i (GLI)	01/93 – 09/97	SUM	TP.A-068	17,5			

Марка автомобиля	Годы выпуска автомобиля	Передние колодки			Задние колодки		
		Тип тормозной системы	№ по каталогу	Толщина изделия, мм	Тип тормозной системы	№ по каталогу	Толщина изделия, мм
TOYOTA							
Carina ED 1,8 ST 200	93-	SUM	TP.A-068	17,5			
Carina ED 1,8 ST 200	93-94	SUM	TP.A-068	17,5			
Carina FF 1,5 AT 192 SX	92-	SUM	TP.A-068	17,5			
Carina FF 1,6 AT 190 SXI	92-	SUM	TP.A-068	17,5			
Carina FF 1,8 AT 191 SXI, SEEXT	94	SUM	TP.A-068	17,5			
Carina FF 1,8 AT 191 SLTD	94	SUM	TP.A-068	17,5			
Carina FF 1,8 ST 190	92-94	SUM	TP.A-068	17,5			
Carina FF 1,8 ST 190 SL	92-94	SUM	TP.A-068	17,5			
Carina FF 2,0 CT 190	92-	SUM	TP.A-068	17,5			
Carina FF 2,0 CT 195	92-	SUM	TP.A-068	17,5			
Carina FF 2,0 ST 195	92-	SUM	TP.A-068	17,5			
Celica 1,6 AA 63	83-86	SUM	TP.A-035	15,5			
Celica 1,6 Coupe 16 TC GTi	86-89	AKB	TP.A 005	15,0			
Celica 1,6 GT Twin Cam 16V	86-89	AKB	TP.A 005	15,0			
Celica 1,6 GT, GTi 16V, ST	85-89	AKB	TP.A 005	15,0			
Celica 1,6 Liftback 16 TC GTi	86-89	AKB	TP.A 005	15,0			
Celica 1,6 16V STi	90-	AKB	TP.A 005	15,0			
Celica 1,6 ST Coupe FWD	86-89	AKB	TP.A 005	15,0			
Celica 1,6 ST Liftback 4WD	86-89	AKB	TP.A 005	15,0			
Celica 1,6i 16V Twin Cam GTi	90-94	AKB	TP.A 005	15,0			
Celica 1,6i GT-S Liftback	83-86	AKB	TP.A 005	15,0			
Celica 1,8 TA 63	82-85	SUM	TP.A-035	15,5			
Celica 1,8 I 16 V Coupe	94-	SUM	TP.A-068	17,5			
Celica 2,0 GA 61	82-85	SUM	TP.A-035	15,5			
Celica 2,0 MA 63	82-85	SUM	TP.A-035	15,5			
Celica 2,0 ST 203	93-	SUM	TP.A-068	17,5			
Celica 2,0i GTi Liftback 16TC	86-89	AKB	TP.A 005	15,0			
Celica 2,0i GTi Liftback 4WD	88-89	AKB	TP.A 005	15,0			
Celica 2,0i 16V Turbo (ABS)	89-	AKB	TP.A 005	15,0			
Celica 2,0i 16V Turbo A Carlos Sainz (ABS)	88-	AKB	TP.A 005	15,0			
Celica 2,8 MA 61	82-85	SUM	TP.A-035	15,5			
Corina 1,6i	92-	SUM	TP.A-068	17,5			
Corina 1,8i	92-	SUM	TP.A-068	17,5			
Corina 2,0i	92-	SUM	TP.A-068	17,5			
Corina 2,0 GT	92-	SUM	TP.A-068	17,5			
Corina 2,0 D	92-	SUM	TP.A-068	17,5			
Corolla 1,3 Commercial (EE 80)	88-90	AKB	TP.A 005	15,0			
Corolla 1,3 DX, DL, SXL, XL, Special, DLX	83-	AKB	TP.A 005	15,0			
Corolla 1,3 Economic Hatchback	87-89	AKB	TP.A 005	15,0			
Corolla 1,3 GL / DX	83-87	AKB	TP.A 005	15,0			
Corolla 1,3 GL, SR, SXL, XL Special	89-	AKB	TP.A 005	15,0			
Corolla 1,3 GT	83-87	AKB	TP.A 005	15,0			
Corolla 1,3 Wagon (AE 80)	83-87	AKB	TP.A 005	15,0			
Corolla 1,3 XL Hatchback (EE 80)	87-89	AKB	TP.A 005	15,0			
Corolla 1,3 XL Liftback (EE 80)	87-89	AKB	TP.A 005	15,0			
Corolla 1,3 XL Sedan (EE 80)	87-89	AKB	TP.A 005	15,0			

Марка автомобиля	Годы выпуска автомобиля	Передние колодки			Задние колодки		
		Тип тормозной системы	№ по каталогу	Толщина изделия, мм	Тип тормозной системы	№ по каталогу	Толщина изделия, мм
TOYOTA							
Corolla 1,3 L Hatchback 	87-89	AKB	TP.A 005	15,0			
Corolla 1,3i Commercial XLi	87-90	AKB	TP.A 005	15,0			
Corolla 1,3i XL, EFi, XLi	92-	AKB	TP.A 005	15,0			
Corolla 1,4 Xli 16 V	92-95	SUM	TP.A-068	17,5			
Corolla 1,4 Xli 16 V Compact	92-95	SUM	TP.A-068	17,5			
Corolla 1,4 Xli 16 V Wagon	92-95	SUM	TP.A-068	17,5			
Corolla 1,4 Xli 16 V Liftback	92-95	SUM	TP.A-068	17,5			
Corolla 1,4 Xli	95-	SUM	TP.A-068	17,5			
Corolla 1,4 Xli Compact	95-	SUM	TP.A-068	17,5			
Corolla 1,4 Xli Wagon	95-	SUM	TP.A-068	17,5			
Corolla 1,4i	87-	AKB	TP.A 005	15,0			
Corolla 1,6 DX, GL, Gli	87-	AKB	TP.A 005	15,0			
Corolla 1,6 GL 16V TC Hatchback	87-89	AKB	TP.A 005	15,0			
Corolla 1,6 GL 16V TC Liftback	87-89	AKB	TP.A 005	15,0			
Corolla 1,6 GL 16V TC Sedan	87-89	AKB	TP.A 005	15,0			
Corolla 1,6 GL <AE 82>	83-87	AKB	TP.A 005	15,0			
Corolla 1,6 S i Compact	92-95	SUM	TP.A-068	17,5			
Corolla 1,6 S i	95-	SUM	TP.A-068	17,5			
Corolla 1,6 S I Wagon	95-	SUM	TP.A-068	17,5			
Corolla 1,6 GTi Liftback	92-95	SUM	TP.A-068	17,5			
Corolla 1,6 Si, SR5, SXL, XL	83-	AKB	TP.A 005	15,0			
Corolla 1,6 Wagon	88-89	AKB	TP.A 005	15,0			
Corolla 1,6 XL 16V 4WD Sedan	88-89	AKB	TP.A 005	15,0			
Corolla 1,6 XL 16V TC Hatchback	87-89	AKB	TP.A 005	15,0			
Corolla 1,6 XL 16V TC Liftback	87-89	AKB	TP.A 005	15,0			
Corolla 1,6 XL 16V 4WD Sedan	87-89	AKB	TP.A 005	15,0			
Corolla 1,6i Commercial XLi	87-90	AKB	TP.A 005	15,0			
Corolla 1,6i GTi 16V TC Hatchback	87-89	AKB	TP.A 005	15,0			
Corolla 1,6i 16V GL, GTi 16	87-	AKB	TP.A 005	15,0			
Corolla 1,6i 16V SR5i, Si, XLi (ABS)	89-	AKB	TP.A 005	15,0			
Corolla 1,8 16 V 4 WD Wagon	95-	SUM	TP.A-068	17,5			
Corolla 1,8 Commercial	88-90	AKB	TP.A 005	15,0			
Corolla 1,8 Commercial XL	87-90	AKB	TP.A 005	15,0			
Corolla 1,8 D DC, DX, GL, Economic	84-87	AKB	TP.A 005	15,0			
Corolla 1,8 D Special, XL	87-	AKB	TP.A 005	15,0			
Corolla 1,8 Diesel DX / DL (CE-80)	83-87	AKB	TP.A 005	15,0			
Corolla 1,8 Diesel XL	87-	AKB	TP.A 005	15,0			
Corolla 1,8 Diesel XL Liftback / Sedan	87-89	AKB	TP.A 005	15,0			
Corolla 1,8i	93-95	SUM	TP.A-068	17,5			
Corolla 2,0 D XL Compact	92-95	SUM	TP.A-068	17,5			
Corolla 2,0 D XL Wagon	93-95	SUM	TP.A-068	17,5			
Corolla 2,0 D XL Liftback	93-95	SUM	TP.A-068	17,5			
Corolla 2,0 D XL	95-	SUM	TP.A-068	17,5			
Corolla 2,0 D XL Wagon	95-	SUM	TP.A-068	17,5			
Corolla Compact 1,3 all models	84-95	AKB	TP.A 005	15,0			
Corolla Compact 1,6 all models, GT 16V	84-92	AKB	TP.A 005	15,0			
Corolla (_E11_) 1.4 D4d	-10/06	TRW	TP.A-098	17,8			
Corolla (_E1_) 2.0 D4d	06/04-	TRW	TP.A-098	17,8			

Марка автомобиля	Годы выпуска автомобиля	Передние колодки			Задние колодки		
		Тип тормозной системы	№ по каталогу	Толщина изделия, мм	Тип тормозной системы	№ по каталогу	Толщина изделия, мм
TOYOTA							
Corolla (_E12U_, E12J_) 1,4 VVT-i	01/02-	TRW	TP.A-098	17,8			
Corolla (_E12U_, E12J_) 1.4 D	07/04-	TRW	TP.A-098	17,8			
Corolla (_E12U_, E12J_) 1.6 VVT-i	01/02-	TRW	TP.A-098	17,8			
Corolla (_E12U_, E12J_) 1.8 VVTL-I, Ø255,0 mm	01/02-05/04	TRW	TP.A-098	17,8			
Corolla (_E12U_, E12J_) 1.8 VVTL-I, Ø275,0 mm	-05/04	TRW	TP.A-098	17,8			
Corolla (_E11_) 1,3 (EE111_)	04/97 – 02/00	SUM	TP.A-068	17,5			
Corolla (_E11_) 1,4 (EE111_)	04/97 – 02/00	SUM	TP.A-068	17,5			
Corolla Combi (-E12J_, E12T_) 1.4VVT-i	-08/02	TRW	TP.A-098	17,8			
Corolla Combi (-E12J_, E12T_) 1.4 D	-08/02	TRW	TP.A-098	17,8			
Corolla Combi 1.6 VVT-i	-06/04	TRW	TP.A-098	17,8			
Corolla Combi 2,0 D4D	01/02-	TRW	TP.A-098	17,8			
Corolla Compact (_E10_) 1,3 XLI (16V) (EE101_)	07/92 – 04/97	SUM	TP.A-068	17,5			
Corolla Compact (_E10_) 1,8 GT (GTi 4WD) (AE102_)	05/92 – 07/95	SUM	TP.A-068	17,5			
Corolla Estate (_E11_) 1.4 D4d	06/04-	TRW	TP.A-098	17,8			
Corolla Estate (_E11_) 2,0 D4d	06/04-	TRW	TP.A-098	17,8			
Corolla Hatchback (_E11_) 1.4, Ø255,0 mm	11/01-	TRW	TP.A-098	17,8			
Corolla Liftback (_E10_) 1,3 XLI (EE101_)	07/92 – 04/97	SUM	TP.A-068	17,5			
Corolla Liftback (_E10_) 1,6 GLI (AE101_)	07/92 – 04/97	SUM	TP.A-068	17,5			
Corolla Liftback (_E10_) 1,8 GT (GTi 4WD) (AE102_)	05/92 – 07/95	SUM	TP.A-068	17,5			
Corolla Liftback (_E10_) 2,0 D (CE100_)	07/92 – 04/97	SUM	TP.A-068	17,5			
Corolla Liftback (_E11_) 1,4 (ZZE111_)	02/00 – 01/02	TRW	TP.A-098	17,8			
Corolla Liftback (_E11_) 1,6 (ZZE112_)	02/00 – 01/02	TRW	TP.A-098	17,8			
Corolla MPV (_E12J_) 1.4 VVT-i	08/02-	TRW	TP.A-098	17,8			
Corolla Saloon (_E12J_) (_E12T_) 1.4 VVT-I Ø255,0 mm	08/02-	TRW	TP.A-098	17,8			
Corolla Saloon (_E12J_) (_E12T_) 1.4 VVT-I Ø275,0 mm	08/02-	TRW	TP.A-098	17,8			
Corolla Saloon (_E12J_) (_E12T_) 1.4D	07/04-	TRW	TP.A-098	17,8			
Corolla Saloon (_E12J_) (_E12T_) 1.6 VVT-i	08/02-	TRW	TP.A-098	17,8			
Corolla Saloon (_E12J_) (_E12T_) 2.0 D-4D	08/02-	TRW	TP.A-098	17,8			

Марка автомобиля	Годы выпуска автомобиля	Передние колодки			Задние колодки		
		Тип тормозной системы	№ по каталогу	Толщина изделия, мм	Тип тормозной системы	№ по каталогу	Толщина изделия, мм
TOYOTA							
Corolla Saloon (_E12J_) (_E12T_) 2.0 D4d Ø254,9 mm	06/04-	TRW	TP.A-098	17,8			
Corolla Saloon (_E12J_) (_E12T_) 2.0 D4d Ø275,0 mm	06/04-	TRW	TP.A-098	17,8			
Corolla Sedan (_E10_) 1,3 XLI (16V) (EE101)	07/92 – 04/97	AKB SUM	TP.A-005 TP.A-068	15,0 17,5			
Corolla Sedan (_E10_) 1,6 Si (AE101_)	09/95 – 04/97	AKB SUM	TP.A-005 TP.A-068	15,0 17,5			
Corolla Sedan (_E10_) 2,0 D (CE100_)	07/92 – 04/97	SUM	TP.A-068	17,5			
Corolla Sedan (_E11_) 1,3 (EE111_)	04/97 – 02/00	SUM	TP.A-068	17,5			
Corolla Sedan (_E11_) 1,4 (EE111_)	04/97 – 02/00	SUM	TP.A-068	17,5			
Corolla Verso 1,4 VVT-I (ZDE12_, CDE12_)	01/02 – 05/04	TRW	TP.A-098	17,8			
Corolla Wagon (_E10_) 1,3 XLI (XLI 16V) (EE101_)	07/92 – 04/97	SUM	TP.A-068	17,5			
Corolla Wagon (_E10_) 1,4 (EE111_)	04/97 – 02/00	SUM	TP.A-068	17,5			
Corolla Wagon (_E11_) 1,4 16V (ZZE111_)	02/00 – 10/01	SUM	TP.A-068	17,5			
Corolla Wagon (_E11_) 1,6 (Aut) (AE111_)	04/97 – 02/00	SUM	TP.A-068	17,5			
Corolla Wagon (_E11_) 1,6 16V (ZZE112_)	02/00 – 10/01	SUM	TP.A-068	17,5			
Corolla Wagon (_E11_) 1,8 4WD (AE115_)	04/97 – 10/01	SUM	TP.A-068	17,5			
Corolla Wagon (_E11_) 1,9 D (WZE110_)	02/00 – 10/01	SUM	TP.A-068	17,5			
Corolla Wagon (_E11_) 2,0 D (CE110_)	04/97 – 02/00	SUM	TP.A-068	17,5			
Corona 1,6 AA 63	83-85	SUM	TP.A-035	15,5			
Corona 1,8 TA 63	82-85	SUM	TP.A-035	15,5			
Corona FF 1,6 AT 190	92-	SUM	TP.A-068	17,5			
Corona FF 1,8 ST 190	92-	SUM	TP.A-068	17,5			
Corona FF 2,0 CT 190	92-	SUM	TP.A-068	17,5			
Corona FF 2,0 CT 195	92-	SUM	TP.A-068	17,5			
Corona FF 2,0 ST 191	92-	SUM	TP.A-068	17,5			
Corona FF 2,0 ST 195	92-	SUM	TP.A-068	17,5			
Cressida 1,8 (Rx60)	80-84	SUM	TP.A 035	15,5			
Cressida 2,0 Dx (Rx60)	80-84	SUM	TP.A 035	15,5			
Cressida 2,0 GL TC24 (Gx70)	84-	SUM	TP.A 035	15,5			
Cressida 2,0 GL TC24 (Gx71)	84-	SUM	TP.A 035	15,5			
Cressida 2,0 Wagon (Gx60)	80-86	SUM	TP.A 035	15,5			
Cressida 2,0i GLi-6 (Gx61)	83-84	SUM	TP.A 035	15,5			
Cressida 2,2 Diesel DX (Lx60)	80-84	SUM	TP.A 035	15,5			
Cressida 2,4 Turbo Diesel GL	84-	SUM	TP.A 035	15,5			
Cressida 2,4 Turbo Wagon GL	84-	SUM	TP.A 035	15,5			

Марка автомобиля	Годы выпуска автомобиля	Передние колодки			Задние колодки		
		Тип тормозной системы	№ по каталогу	Толщина изделия, мм	Тип тормозной системы	№ по каталогу	Толщина изделия, мм
TOYOTA							
Cressida 2,6 (Mx63)	80-84	SUM	TP.A 035	15,5			
Cressida 2,8 Wagon (Mx62)	80-84	SUM	TP.A 035	15,5			
Cressida 2,8i GLX (Gx71)	84-	SUM	TP.A 035	15,5			
Cressida 2,8i GLX (Rx70)	84-	SUM	TP.A 035	15,5			
Curren 2,0 ST 207	94-	SUM	TP.A-068	17,5			
Curren 2,0 ST 206 FS, XS	94-	SUM	TP.A-068	17,5			
Cynos Coupe (EL44) 1,5	04/91 – 08/95	AKB	TP.A-005	15,0			
Cynos Coupe (EL54) 1,3	08/95 – 04/00	AKB	TP.A-005	15,0			
Cynos Coupe (EL54) 1,5	08/95 – 04/00	AKB	TP.A-005	15,0			
Cynos Coupe (EL54) 1,5 16V	08/95 – 07/99	AKB	TP.A-005	15,0			
Estima (TCR2_, TCR1_) 2,4 (4WD)	05/90 – 08/00	AKE	TP.A-062/ TP.A-052	15,5			
Hilux 2,0 DLX, SP5, STD	83-86	SUM	TP.A 035	15,5			
Hilux II Pick-Up 2,4 D (4WD)	08/88 – 07/05	SUM	TP.A-045	15,0			
Hilux II Pick-Up 2,4i 4WD	06/89 – 07/05	SUM	TP.A-045	15,0			
Hilux II Pick-Up 2,4 TD 4WD	08/98 – 01/02	SUM	TP.A-045	15,0			
Hilux II Pick-Up 2,5 D-4D 4WD	11/01 – 07/05	SUM	TP.A-045	15,0			
Hilux Surf 2,4 (RN61)	08/87 – 03/96	SUM	TP.A-045	15,0			
Hilux Surf 2,7i	11/95 – 03/96	SUM	TP.A-045	15,0			
Hilux Surf 3,0 V6 (VZN 130)	07/90 – 11/95	SUM	TP.A-045	15,0			
Hilux Surf 3,4i	11/95 – 03/96	SUM	TP.A-045	15,0			
Land Cruiser 2,4 (RJ70_V, RJ73_V)	11/84 – 12/96	SUM	TP.A-045	15,0			
Land Cruiser 2,4 TD (LJ70)	01/90 – 05/93	SUM	TP.A-045	15,0			
Land Cruiser 3,0 TD (KZJ70_, KZJ73_, KZJ77_)	05/93 – 05/96	SUM	TP.A-045	15,0			
Land Cruiser 3,4 D (BJ70_V, BJ73_)	11/84 – 12/96	SUM	TP.A-045	15,0			
Land Cruiser 4,2 TD (HZJ7__V)	01/90 –	SUM	TP.A-045	15,0			
Land Cruiser (_J8_) 4,2 TD 24V (HDJ80_)	01/90 – 12/97	SUM	TP.A-045	15,0			
Land Cruiser (_J8_) 4,5 24V (FZJ80_)	08/92 – 12/97	SUM	TP.A-045	15,0			
Land Cruiser 80 (_J8_) 4,2 TD 24V (HDJ80_)	03/95 – 12/97	SUM	TP.A-045	15,0			
Land Cruiser 80 (_J8_) 4,5 24V (FZJ80_)	08/92 – 12/97	SUM	TP.A-045	15,0			

Марка автомобиля	Годы выпуска автомобиля	Передние колодки			Задние колодки		
		Тип тормозной системы	№ по каталогу	Толщина изделия, мм	Тип тормозной системы	№ по каталогу	Толщина изделия, мм
TOYOTA							
Land Cruiser 90 (_J9_) 3,0 D-4D (KDJ90, KDJ95, KDJ125)	10/00 –	SUM	TP.A-045	15,0			
Land Cruiser 90 (_J9_) 3,0 TD (KZJ90_, KZJ95_)	04/96 –	SUM	TP.A-045	15,0			
Land Cruiser 90 (_J9_) 3,4i 24V (VZJ90_, VZJ95_)	04/96 –	SUM	TP.A-045	15,0			
Land Cruiser Bundera 2,4 (RJ70_V, RJ73_V)	11/84 – 12/96	SUM	TP.A-045	15,0			
Land Cruiser Bundera 3,0 TD (KZJ70_, KZJ73_, KZJ77_)	05/93 – 05/96	SUM	TP.A-045	15,0			
Land Cruiser Bundera 3,4 D (BJ70_V, BJ73_)	11/84 – 12/96	SUM	TP.A-045	15,0			
Land Cruiser Bundera 4,2 TD (HZJ7_V)	01/90 –	SUM	TP.A-045	15,0			
Land Cruiser Hardtop (_J7_) 2,4 TD (LJ77)	07/90 – 05/96	SUM	TP.A-045	15,0			
Land Cruiser Hardtop (_J7_) 3,0 TD	05/93 – 05/96	SUM	TP.A-045	15,0			
Land Cruiser Prado (_J9_) 3,0 D-4D (KDJ90, KDJ95, KDJ 125)	10/00 –	SUM	TP.A-045	15,0			
Land Cruiser Prado (_J9_) 3,0 TD (KZJ90_, KZJ95_)	04/96 –	SUM	TP.A-045	15,0			
Lite Ace 1,5 (KM36)	86-92	AKE	TP.A-051 TP.A-052	15,5			
Liteace 1,3	82-9/86	AKE	TP.A-051 TP.A-052	15,5			
Liteace 1,5 Combi / Commercial	3/86	AKE	TP.A-051 TP.A-052	15,5			
Liteace 1,6 all models	82-9/86	AKE	TP.A-051 TP.A-052	15,5			
Liteace 1,8 Combi/ Commercial	86-6/91	AKE	TP.A-051 TP.A-052	15,5			
Liteace 1,8 Diesel / Double Tire	82-2/86	AKE	TP.A-051 TP.A-052	15,5			
Liteace 1,8 Wagon DX Diesel	87-6/91	AKE	TP.A-62/52	15,5			
Liteace 2,0 F Van/Wagon	9/82-	AKE	TP.A-62/52	15,5			
Liteace 2,0 Diesel Van	3/86-	AKE	TP.A-62/52	15,5			
Liteace 2,0 Wagon	5/92-	AKE	TP.A-62/52	15,5			
Liteace 2,0 d2x Break Diesel	93-	AKE	TP.A-62/52	15,5			
Liteace Bus 1,5 (KM30LG)	10/85 – 01/92	AKE	TP.A-051 TP.A-052	15,5			
Liteace Bus 1,5 (KR21LG)	01/92 – 01/95	AKE	TP.A-051 TP.A-052	15,5			
Liteace Bus 2,0 D (CM30LG)	08/88 – 01/92	AKE	TP.A-051 TP.A-052	15,5			
Liteace Bus 2,0 D (CR21LG)	01/92 – 05/94	AKE	TP.A-051 TP.A-052	15,5			
Liteace Bus 2,2 (YR22LG)	01/92 – 01/95	AKE	TP.A-051 TP.A-052	15,5			
Liteace Van 1,5 (KM31_V, KM36_V)	05/86 – 09/91	AKE	TP.A-051 TP.A-052	15,5			
Liteace Van 1,5 (KR27_V)	01/92 – 01/95	AKE	TP.A-051 TP.A-052	15,5			

Марка автомобиля	Годы выпуска автомобиля	Передние колодки			Задние колодки		
		Тип тормозной системы	№ по каталогу	Толщина изделия, мм	Тип тормозной системы	№ по каталогу	Толщина изделия, мм
TOYOTA							
Liteace Van 2,0 D (CM36_V)	08/88 – 01/92	AKE	TP.A-051 TP.A-052	15,5			
Liteace Van 2,0 D (CR27_V)	01/92 – 05/94	AKE	TP.A-051 TP.A-052	15,5			
Liteace Van 2,2 (YR29LV)	01/92 – 01/95	AKE	TP.A-051 TP.A-052	15,5			
Mark II, Chaser, Cresta 1,8 SX 60	82-84	SUM	TP.A-035	15,5			
Mark II, Chaser, Cresta 1,8 SX 70	84-88	SUM	TP.A-035	15,5			
Mark II, Chaser, Cresta 1,8 TX 67V	80-84	SUM	TP.A-035	15,5			
Mark II, Chaser, Cresta 1,8 YX 70	84-88	SUM	TP.A-035	15,5			
Mark II, Chaser, Cresta 1,8 YX 76V	84-93	SUM	TP.A-035	15,5			
Mark II, Chaser, Cresta 2,0 GX 60G	80-84	SUM	TP.A-035	15,5			
Mark II, Chaser, Cresta 2,0 GX 61 LE, LG, SXL, SDX	80-84	SUM	TP.A-035	15,5			
Mark II, Chaser, Cresta 2,0 GX61LGT, GD, SGT, AVT, STL	83-84	SUM	TP.A-035	15,5			
Mark II, Chaser, Cresta 2,0 (IG-GEU) GD, AVT, LST	82-84	SUM	TP.A-035	15,5			
Mark II, Chaser, Cresta 2,0 GX 70G	84	SUM	TP.A-035	15,5			
Mark II, Chaser, Cresta 2,0 GX 71	84-88	SUM	TP.A-035	15,5			
Mark II, Chaser, Cresta 2,0 GX 71 (R DISC)	84-88	SUM	TP.A-035	15,5			
Mark II, Chaser, Cresta 2,0 MX 60	80-84	SUM	TP.A-035	15,5			
Mark II, Chaser, Cresta 2,0 MX 61	83-84	SUM	TP.A-035	15,5			
Mark II, Chaser, Cresta 2,0 MX 71	84-85	SUM	TP.A-035	15,5			
Mark II, Chaser, Cresta 2,0 YX 72	86-88	SUM	TP.A-035	15,5			
Mark II, Chaser, Cresta 2,0 YX 78V	93	SUM	TP.A-035	15,5			
Mark II, Chaser, Cresta 2,2 LX 60	80-84	SUM	TP.A-035	15,5			
Mark II, Chaser, Cresta 2,2 LX 67V	80-84	SUM	TP.A-035	15,5			
Mark II, Chaser, Cresta 2,4 LX 65	82-84	SUM	TP.A-035	15,5			
Mark II, Chaser, Cresta 2,4 LX 70	84-88	SUM	TP.A-035	15,5			
Mark II, Chaser, Cresta 2,4 LX 76V	84	SUM	TP.A-035	15,5			
Mark II, Chaser, Cresta 2,4 LX 90	92-	SUM	TP.A-068	17,5			
MR 2 I (AW11) 1,6 16V	11/84 – 06/90	AKB	TP.A-005	15,0			
Master Ase	88-92	AKE	TPA-051/052	15,5			
Paseo Convertible (EL54) 1,5	10/96 – 04/00	AKB	TP.A-005	15,0			
Paseo Coupe (EL44) 1,5	04/91 – 08/95	AKB	TP.A-005	15,0			
Paseo Coupe (EL54) 1,3	08/95 – 04/00	AKB	TP.A-005	15,0			
Paseo Coupe (EL54) 1,5	08/95 – 04/00	AKB	TP.A-005	15,0			
Paseo Coupe (EL54) 1,5 16V	08/95 – 07/99	AKB	TP.A-005	15,0			
Previa 2,4i DX	9/90-	AKE	TPA-62/52	15,5			
Previa 2,4 GL	9/90-	AKE	TPA-62/52	15,5			
Previa 2,4 XL	9/90-	AKE	TPA-62/52	15,5			

Марка автомобиля	Годы выпуска автомобиля	Передние колодки			Задние колодки		
		Тип тормозной системы	№ по каталогу	Толщина изделия, мм	Тип тормозной системы	№ по каталогу	Толщина изделия, мм
TOYOTA							
Previa 2,5 GL/XL 16V	5/90	AKE	TPA-6252	15,5			
Previa 2,5 XL/DX/4WD	5/90-	AKE	TPA-6252	15,5			
L-Runner 2,4	87-89	SUM	TP.A 045	15,0			
L-Runner 3,0 V6	87-89	SUM	TP.A 045	15,0			
4-Runner (N 13) 2,4	89-96	SUM	TP.A 045	15,0			
4-Runner (N 13) 3,0 V6	90-	SUM	TP.A 045	15,0			
4-Runner (N 13) 2,4 TD	89-96	SUM	TP.A 045	15,0			
4-Runner (N 13) 2,8 D	89-96	SUM	TP.A 045	15,0			
4-Runner (N 13) 3,0 Turbo Diesel	93-	SUM	TP.A 045	15,0			
4-Runner (N 13) 2,7i	11/95 – 03/96	SUM	TP.A-045	15,0			
4-Runner (N 13) 3,4i	11/95 – 03/96	SUM	TP.A-045	15,0			
Runx 1,4 D (ZZE12_, NDE12_, ZDE12_)	07/04 – 02/07	TRW	TP.A-098	17,8			
Runx 1,4 VVT-I (ZZE12_, NDE12_, ZDE12_)	01/02 – 12/06	TRW	TP.A-098	17,8			
Runx 1,6 VVT-I (ZZE12_, NDE12_, ZDE12_)	01/02 – 12/06	TRW	TP.A-098	17,8			
Runx 1,8 VVTL-i TS (ZZE12_, NDE12_, ZDE12_)	01/02 – 02/07	TRW	TP.A-098	17,8			
Runx 2,0 D-4D (ZZE12_, NDE12_, ZDE12_)	01/02 – 02/07	TRW	TP.A-098	17,8			
Hihux (N 8) 2,4 Diesel	89-	SUM	TP.A 045	15,0			
Hihux (N 8) 2,4 Diesel 4WWD	89-	SUM	TP.A 045	15,0			
MR 2 1,6 Twin Cam (AW 10/11)	85-90	AKB	TP.A 005	15,0			
MR 2 1,6i 16V GT	84-89	AKB	TP.A 005	15,0			
MR 2 2,0i 16V GTi all models	92-	AKB	TP.A 005	15,0			
RAV4 SXA 11G	95-	SUM	TP.A-068	17,5			
RAV 4 2,0 16 V	94-	SUM	TP.A-068	17,5			
Scepter 2,2 SXV 10	92-	SUM	TP.A-068	17,5			
Scepter 2,2 SXV 15 W	92-	SUM	TP.A-068	17,5			
Soarer 2,0 GZ10, MZ10	82-85	SUM	TP.A-035	15,5			
Soarer 2,8 MZ11	82-85	SUM	TP.A-035	15,5			
Soarer 3,0 MZ12	82-85	SUM	TP.A-035	15,5			
Spacia Bus 1,5 (KR21LG)	01/92 – 01/95	AKE	TP.A-051 TP.A-052	15,5			
Spacia Bus 2,0 D (CR21LG)	01/92 – 05/94	AKE	TP.A-051 TP.A-052	15,5			
Spacia Bus 2,2 (YR22LG)	01/92 – 01/95	AKE	TP.A-051 TP.A-052	15,5			
Spase Cruiser 2,0 Estate (YR21)	84-90	AKE	TPA-051/052	15,5			

Марка автомобиля	Годы выпуска автомобиля	Передние колодки			Задние колодки		
		Тип тормозной системы	№ по каталогу	Толщина изделия, мм	Тип тормозной системы	№ по каталогу	Толщина изделия, мм
TOYOTA							
Starlet 1,0 all models, GL, XL (ABS)	89-	AKB	TP.A 005	15,0			
Starlet 1,3 GL. S (ABS)	90-	AKB	TP.A 005	15,0			
Starlet 1,3 XL Automatic (ABS)	89-	AKB	TP.A 005	15,0			
Starlet 1,3i Friend, GLi (ABS)	91-	AKB	TP.A 005	15,0			
Starlet 1,3i, Si, XL, XLi (ABS)	91-	AKB	TP.A 005	15,0			
Supra 3,0i Twin Cam 24V	88-	AKB	TP.A 005	15,0			
Supra 3,0i Twin Cam Turbo	88-	AKB	TP.A 005	15,0			
Surf	88-92	AKE	TPA-051/052	15,5			
Surf 2,4 (RN61)	08/87 – 03/96	SUM	TP.A-045	15,0			
Surf 2,7i	11/95 – 03/96	SUM	TP.A-045	15,0			
Surf 3,0 V6 (VZN 130)	07/90 – 11/95	SUM	TP.A-045	15,0			
Surf 3,4i	11/95 – 03/96	SUM	TP.A-045	15,0			
Tacoma II Pick-Up 2,2 4WD (YN106_, YN110_)	01/87 – 12/89	SUM	TP.A-045	15,0			
Tacoma II Pick-Up 2,4 D (4WD)	08/88 – 07/05	SUM	TP.A-045	15,0			
Tacoma II Pick-Up 2,4i 4WD	06/89 – 07/05	SUM	TP.A-045	15,0			
Tacoma II Pick-Up 2,4 TD 4WD	08/98 – 01/02	SUM	TP.A-045	15,0			
Tacoma II Pick-Up 2,5 D-4D 4WD	11/01 – 07/05	SUM	TP.A-045	15,0			
Tarago (TCR2_, TCR1_) 2,4 (4WD)	05/90 – 08/00	AKE	TP.A-062/ TP.A-052	15,5			
Tercel 1,3 DX, GL.L, SR, D XL	82-85	AKB	TP.A 005	15,0			
Tercel 1,5 DLX, GL	82-	AKB	TP.A 005	15,0			
Tercel 1,5i	90-	SUM	TP.A-068	17,5			
Tercel 1,5i 4 WD	93-	SUM	TP.A-068	17,5			
Tercel 1,5 TD	90-	SUM	TP.A-068	17,5			
VAUXHALL							
Astra 1,2	84-91	ATE	TP.A 002	14,5			
Astra 1,2 Estate	80-84	ATE	TP.A 002	14,5			
Astra 1,2 Estate Hatchback	80-84	ATE	TP.A 002	14,5			
Astra 1,3	84-89	ATE	TP.A 002	14,5			
Astra 1,3 Estate	80-84	ATE	TP.A 002	14,5			
Astra 1,3 Hatchback	80-84	ATE	TP.A 002	14,5			
Astra 1,4 Estate	89-91	ATE	TP.A 002	14,5			
Astra 1,4 Hatchback	89-91	ATE	TP.A 002	14,5			
Astra A 1,4 all models (ABS)	91-94	ATE	TP.A 038	16,5			
Astra A 1,4 all models (ABS)	94-95	ATE	TP.A 017	18,0			

Марка автомобиля	Годы выпуска автомобиля	Передние колодки			Задние колодки		
		Тип тормозной системы	№ по каталогу	Толщина изделия, мм	Тип тормозной системы	№ по каталогу	Толщина изделия, мм
VAUXHALL							
Astra 1,6 Diesel	89-91	ATE	TP.A 002	14,5			
Astra 1,6i (E-Drive)	93-96	ATE	TP.A 038	16,5			
Astra 1,6 Estate	80-91	ATE	TP.A 002	14,5			
Astra 1,6 Hatchback	80-91	ATE	TP.A 002	14,5			
Astra 1,6 SR Hatchback	84-91	ATE	TP.A 002	14,5			
Astra 1,7 Diesel	89-91	ATE	TP.A 002	14,5			
Astra 1,7 Diesel Estate	89-91	ATE	TP.A 002	14,5			
Astra 1,7 Turbo Diesel	82-	ATE	TP.A 038	16,5			
Astra A 1,8 all models (ABS)	94-96	ATE	TP.A 017	18,0			
Astra 1,8i	93-96	ATE	TP.A 038	16,5			
Astra 1,8i Convertible	93-	ATE	TP.A 038	16,5			
Astra 1,8i Gsi 16V	83-84	ATE	TP.A 038	16,5			
Astra A 2,0 all models (ABS)	91-94	ATE	TP.A 017	18,0			
Astra A 2,0 CDX (ABS)	95-96	ATE	TP.A 017	18,0			
Astra A 2,0 Sri (ABS)	91-94	ATE	TP.A 017	18,0			
Astra 2,0i	87-91	ATE	TP.A 002	14,5			
Astra A 1,7 D all models (ABS)	91-96	ATE	TP.A 038	16,5			
Astra E 1,8 all models	84-91	GM	TP.A 002	14,5			
Astra E 2,0 all models	86-91	GM	TP.A 002	14,5			
Astra Belmont 1,4; 1,6; 1,7 D	89-91	ATE	TP.A 002	14,5			
Astra Belmont 1,8 all models	87-91	GM	TP.A 002	14,5			
Astra Van 1,6	91-94	ATE	TP.A 038	16,5			
Astra Van 1,7 D all models	94-96	ATE	TP.A 038	16,5			
Astramat 1,4 all models	90-91	GM	TP.A 002	14,5			
Astra Cabrio 1,6	93-	ATE	TP.A 038	16,5			
Astra Cabrio 1,6i	81-93	ATE	TP.A 038	16,5			
Astra Estate 1,4	91-96	ATE	TP.A 038	16,5			
Astra Estate 1,4i	81-86	ATE	TP.A 038	16,5			
Astra Estate 1,6	92-96	ATE	TP.A 038	16,5			
Astra Estate 1,6i / E-Drive	93-	ATE	TP.A 038	16,5			
Astra Estate 1,6i 16 V	94-96	ATE	TP.A 038	16,5			
Astra Estate 1,7 Diesel	91-94	ATE	TP.A 038	16,5			
Astra Estate 1,7 Turbo Diesel	92-	ATE	TP.A 038	16,5			
Astra Estate 1,8i	93-94	ATE	TP.A 038	16,5			
Astra max 365-560 1,6i	81-84	ATE	TP.A 038	16,5			
Calibra 2,0i	90-	ATE	TP.A 017	18,0			
Calibra 2,0i 16V 4WD	90-	ATE	TP.A 017	18,0			
Calibra 2,0i 16V 4WD (ABS)	90-	ATE	TP.A 017	18,0			
Carlton A 1,8 all models (ABS)	86-89	GM	TP.A 002	14,5			
Carlton A 1,8 all models (ABS)	89-91	ATE	TP.A 017	18,0			
Carlton A 2,0 all models (ABS)	86-88	GM	TP.A 002	14,5			
Carlton A 2,0 all models	88-94	ATE	TP.A 017	18,0			
Carlton 2,0i GL / CD	89-				DEL	TP.A 010	15,0
Carlton A 2,3 D all models	86-89	GM	TP.A 002	14,5			

Марка автомобиля	Годы выпуска автомобиля	Передние колодки			Задние колодки		
		Тип тормозной системы	№ по каталогу	Толщина изделия, мм	Тип тормозной системы	№ по каталогу	Толщина изделия, мм
VAUXHALL							
Carlton 3,0i 24V CDX Estate	90-				DEL	TP.A 010	15,0
Cavalier 1,3 L, LS, S, GL, GLS	81-83	GM	TP.A 002	14,5			
Cavalier 1,4i L	89-	GM	TP.A 002	14,5			
Cavalier 1,6 D GL, L, LX	81-88	GM	TP.A 002	14,5			
Cavalier 1,6 L, LS, S, GL, GLS, Club	81-88	GM	TP.A 002	14,5			
Cavalier 1,6 SR	81-83	GM	TP.A 002	14,5			
Cavalier 1,7 Diesel	92-	ATE	TP.A 038	16,5			
Cavalier 1,7 Turbo Diesel	92-96	ATE	TP.A 038	16,5			
Cavalier 1,7 Diesel CD (ABS)	89-	GM	TP.A 002	14,5			
Cavalier 1,8 all models	81-88	GM	TP.A 002	14,5			
Cavalier 1,9 GL, GLS	75-81	GM	TP.A 002	14,5			
Cavalier 2,0 GL, GLS, L, LS	75-81	GM	TP.A 002	14,5			
Cavalier 2,0i CDi, SRi, GLSi	86-88	GM	TP.A 002	14,5			
Cavalier 2,0i 16V SRi, (ABS)	89-	ATE	TP.A 017	18,0			
Cavalier 2,0i 4WD	90-	ATE	TP.A 017	18,0			
Chevette 1,2	75-82	ATE	TP.A 001	15,0			
Chevette 1,3	75-76	ATE	TP.A 001	15,0			
Chevette 2,3 HS	77-82	ATE	TP.A 001	15,0			
Combo 1,4i	93-	ATE	TP.A 038	16,5			
Combo A 1,4 all models	95-96	ATE	TP.A 017	18,0			
Combo A 1,6 all models (ABS)	91-95	ATE	TP.A 038	16,5			
Combo A 1,7 D all models (ABS)	95-96	ATE	TP.A 038	16,5			
Combo 1.6	08/01-	TRW	TP.A-101	16,8			
Combo 1.7 DI 16V	09/01-	TRW	TP.A-101	16,8			
Combo 1.7 DII 16V	10/01-	TRW	TP.A-101	16,8			
Corsa 1,2i	93-97	ATE	TP.A 038	16,5			
Corsa 1,2i E-Drive	93-97	ATE	TP.A 038	16,5			
Corsa 1,4i	93-97	ATE	TP.A 038	16,5			
Corsa 1,4i (Hi Torg)	93-94	ATE	TP.A 038	16,5			
Corsa 1,4i 16V	94-97	ATE	TP.A 038	16,5			
Corsa 1,4i Sport	95-97	ATE	TP.A 038	16,5			
Corsa 1,5 Diesel	93-97	ATE	TP.A 038	16,5			
Corsa 1,5 Turbo Diesel	93-97	ATE	TP.A 038	16,5			
Corsa MK II 1,0 12V ABS(+) ABS(-)	09/00-	TRW	TP.A-101	16,8			
Corsa MK II 1.2 16V Dualfuel ABS(+); ABS(-)	08/01-	TRW	TP.A-101	16,8			
Corsa MK II 1.3 CDTI 16V ABS(+)	04/04-	TRW	TP.A-101	16,8			
Corsa MK II 1.4 16V, ABS(+)	09/00-	TRW	TP.A-101	16,8			
Corsa MK II 1.7 CDTI 16V	04/04-	TRW	TP.A-101	16,8			
Corsa MK II 1.7 DI 16V	09/00-	TRW	TP.A-101	16,8			
Corsa MK II 1.7 DII 16V, ABS(+)	09/00-	TRW	TP.A-101	16,8			
Corsa MK II 1.8 16V	09/00-	TRW	TP.A-101	16,8			

Марка автомобиля	Годы выпуска автомобиля	Передние колодки			Задние колодки		
		Тип тормозной системы	№ по каталогу	Толщина изделия, мм	Тип тормозной системы	№ по каталогу	Толщина изделия, мм
VAUXHALL							
Corsavan 1,4 all models	94-	ATE	TP.A 038	16,5			
Corsavan 1,7 D all models	94-	ATE	TP.A 038	16,5			
Corsavan MK II 1.2 16V, ABS(+)	08/01-07/04	TRW	TP.A-101	16,8			
Corsavan MK II 1.2 16V	08/01-07/04	TRW	TP.A-101	16,8			
Corsavan MK II 1.2 16V Dualfuel	08/01-07/04	TRW	TP.A-101	16,8			
Corsavan MK II 1.4	11/03-11/06	TRW	TP.A-101	16,8			
Corsavan MK II 1.7 DI 16V	09/00-	TRW	TP.A-101	16,8			
Corsavan MK II 1.7 DTI 16V	09/00-	TRW	TP.A-101	16,8			
Meriva 1.4 16V Twinpost 14"	07/04-	TRW	TP.A-101	16,8			
Meriva 1.6 i	05/03-	TRW	TP.A-101	16,8			
Nova A 1,0 all models	82-90	GM	TP.A 002	14,5			
Nova 1,0	92-	ATE	TP.A 038	16,5			
Nova A 1,2 GL, GLS, LS	82-90	GM	TP.A 002	14,5			
Nova A 1,2i Joy, Sport, Swing	90-91	GM	TP.A 002	14,5			
Nova A 1,2i Joy, Sport, Swing	92-	ATE	TP.A 038	16,5			
Nova A 1,3 GL, GLS, LS	82-90	GM	TP.A 002	14,5			
Nova A 1,4i Joy, Sport, Swing	82-90	GM	TP.A 002	14,5			
Nova A 1,4i Joy, Sport, Swing	91-	ATE	TP.A 038	16,5			
Nova A 1,6 I GSi	88-	GM	TP.A 002	14,5			
Nova A 1,6 I GSi	90-	ATE	TP.A 038	16,5			
Nova A 1,5 D all models	87-91	GM	TP.A 002	14,5			
Nova A 1,5 D City, Sport, Swing, Turbo	92-	ATE	TP.A 038	16,5			
Senator 2,5i	89-				DEL	TP.A 010	15,0
Senator 3,0i LE Factr. (ABS)	89-				DEL	TP.A 010	15,0
Tigra A 1,4i 16V	94-	ATE	TP.A 038	16,5			
Tigra A 1,6i 16V	94-	ATE	TP.A 038	16,5			
Tigra 2,2 all models	94-	ATE	TP.A 038	16,5			
Tigra 3,0 all models	94-	ATE	TP.A 038	16,5			
Tigra Convertible (06/04-) 1.3 CDTI	06/04-	TRW	TP.A-101	16,8			
Tigra Convertible (06/04-) 1.4	06/04-	TRW	TP.A-101	16,8			
Tigra Convertible (06/04-) 1.8	06/04-	TRW	TP.A-101	16,8			
Vectra B 1,6 all models	95-	ATE	TP.A 017	18,0			
Vectra B 1,8 all models	95-	ATE	TP.A 017	18,0			
Vectra B 2,0 all models	95-	ATE	TP.A 017	18,0			
Vectra B 1,7 D all models	95	ATE	TP.A 017	18,0			
VOLKSWAGEN							
411 1.7 All Models	68-	ATE	TP.A-001	15,0			
412 1.7 All Models	68-	ATE	TP.A-001	15,0			
412 1,8 All Models	73-	ATE	TP.A-001	15,0			
Amarok 2,0 BiTDI	09/10 –	BO	TP.A-089	19,0			
Amarok 2,0 BiTDI 4 motion	09/10 –	BO	TP.A-089	19,0			
Amarok 2,0 TDI / TSI	09/10 –	BO	TP.A-089	19,0			

Марка автомобиля	Годы выпуска автомобиля	Передние колодки			Задние колодки		
		Тип тормозной системы	№ по каталогу	Толщина изделия, мм	Тип тормозной системы	№ по каталогу	Толщина изделия, мм
VOLKSWAGEN							
Amarok 2,0 TDI 4 motion	09/10 –	ВО	ТР.А-089	19,0			
Beetle (5C1) 1,2 TSI	07/11 –	ATE	ТР.А-065 ТР.А-092 ТР.А-093	19,8			
Beetle (5C1) 1,4 TSI	04/11 –	ATE	ТР.А-065 ТР.А-092 ТР.А-093	19,8			
Beetle (5C1) 1,6 TDI	10/11 –	ATE	ТР.А-065 ТР.А-092 ТР.А-093	19,8			
Beetle (5C1) 2,0 TDI / TSI	04/11 –	ATE	ТР.А-065 ТР.А-092 ТР.А-093	19,8			
Beetle (5C1) 2,5	04/11 –	ATE	ТР.А-065 ТР.А-092 ТР.А-093	19,8			
Beetle Cabrio (5C7) 1,2 TSI	12/12 –	ATE	ТР.А-065 ТР.А-092 ТР.А-093	19,8			
Beetle Cabrio (5C7) 1,4 TSI	12/12 –	ATE	ТР.А-065 ТР.А-092 ТР.А-093	19,8			
Beetle Cabrio (5C7) 1,6 TDI	12/12 –	ATE	ТР.А-065 ТР.А-092 ТР.А-093	19,8			
Beetle Cabrio (5C7) 2,0 TDI / TSI	12/12 –	ATE	ТР.А-065 ТР.А-092 ТР.А-093	19,8			
Bora (1J2) 1,6 16V	05/00 – 05/05	ATE	ТР.А-093	19,8			
Bora (1J2) 1,6 FSI	01/02 – 05/05	ATE	ТР.А-093	19,8			
Bora (1J2) 1,8 T	05/00 – 05/05	ATE	ТР.А-093	19,8			
Bora (1J2) (10/98-07/05) 1.4 16V	03/00-05/05	ATE	ТР.А-092/ ТР.А-093	19,8			
Bora (1J2) (10/98-07/05) 1.6	10/98-05/05	ATE	ТР.А-092/ ТР.А-093	19,8			
Bora (1J2) (10/98-07/05) 1.8	10/98-05/05	ATE	ТР.А-092/ ТР.А-093	19,8			
Bora (1J2) 1.8 4 motion Ø256,0 mm	02/99-05/05	ATE	ТР.А-092/ ТР.А-093	19,8			
Bora (1J2) 1.8 4 motion (1J2) Ø280,0 mm	02/99-05/05	ATE	ТР.А-092/ ТР.А-093	19,8			
Bora (1J2) 1.9 SDI	10/98-05/05	ATE	ТР.А-092/ ТР.А-093	19,8			
Bora (1J2) 1.9 TDI Ø280,0 mm	10/98-05/05	ATE	ТР.А-092/ ТР.А-093	19,8			
Bora (1J2) 1.9 TDI Ø288 mm	02/99-05/05	ATE	ТР.А-092/ ТР.А-093	19,8			
Bora (1J2) 1.9 TDI 4 motion Ø288 mm	02/99-05/05	ATE	ТР.А-092/ ТР.А-093	19,8			

Марка автомобиля	Годы выпуска автомобиля	Передние колодки			Задние колодки		
		Тип тормозной системы	№ по каталогу	Толщина изделия, мм	Тип тормозной системы	№ по каталогу	Толщина изделия, мм
VOLKSWAGEN							
Bora (1J2) 1.9 TDI 4 motion Ø288 mm	02/99-05/05	ATE	TP.A-092/ TP.A-093	19,8			
Bora (1J2) 2.0 Ø280,0 mm	10/98-05/05	ATE	TP.A-092/ TP.A-093	19,8			
Bora (1J2) 2.0 Ø288,0 mm	10/98-05/05	ATE	TP.A-092/ TP.A-093	19,8			
Bora (1J2) 2.0 4 motion, 15"	04/00-05/05	ATE	TP.A-092/ TP.A-093	19,8			
Bora Estate (1J6) 1.4 16V	05/99-05/05	ATE	TP.A-092/ TP.A-093	19,8			
Bora Estate (1J6) 1.6	05/99-05/05	ATE	TP.A-092/ TP.A-093	19,8			
Bora Estate (1J6) 1.6 16V	02/00-05/05	ATE	TP.A-092/ TP.A-093	19,8			
Bora Estate (1J6) 1.6 FSI	01/02-05/05	ATE	TP.A-092/ TP.A-093	19,8			
Bora Estate (1J6) 1.6 FSI	01/02-05/05	ATE	TP.A-092/ TP.A-093	19,8			
Bora Estate (1J6) 1.8 4 motion	05/99-05/05	ATE	TP.A-092/ TP.A-093	19,8			
Bora Estate (1J6) 1.8 T 15" Ø256 mm	05/00-05/05	ATE	TP.A-092/ TP.A-093	19,8			
Bora Estate (1J6) 1.8 T 15" Ø280,0 mm	05/05-05/05	ATE	TP.A-092/ TP.A-093	19,8			
Bora Estate (1J6) 1.9 SDI	06/01-05/05	ATE	TP.A-092/ TP.A-093	19,8			
Bora Estate (1J6) 1.9 TDi, Ø280 mm	05/99-05/05	ATE	TP.A-092/ TP.A-093	19,8			
Bora Estate (1J6) 1.9 TDi, Ø288 mm	05/99-05/05	ATE	TP.A-092/ TP.A-093	19,8			
Bora Estate (1J6) 1.9 TDi 4 motion 15", Ø280 mm	05/99-05/05	ATE	TP.A-092/ TP.A-093	19,8			
Bora Estate (1J6) 1.9 TDi 4 motion 15", Ø288,0 mm	05/99-05/05	ATE	TP.A-092/ TP.A-093	19,8			
Bora Estate (1J6) 1.9 TDi 4 motion 15", Ø280 mm	05/99-05/05	ATE	TP.A-092/ TP.A-093	19,8			
Bora Estate (1J6) 1.9 TDi 4 motion 15", Ø288,0 mm	05/99-05/05	ATE	TP.A-092/ TP.A-093	19,8			
Bora Estate (1J6) 2.0	05/99-05/05	ATE	TP.A-092/ TP.A-093	19,8			
Bora Estate (1J6) 2.0 4 motion 15"	05/99-05/05	ATE	TP.A-092/ TP.A-093	19,8			
Bora Estate (1J6) 1.4 16V	09/01-05/05	ATE	TP.A-092/ TP.A-093	19,8			
Bora Sedan (1J2) 1,4 16V	03/00 – 05/05	ATE	TP.A-092 TP.A-093	19,8			
Bora Sedan (1J2) 1,6	10/98 – 05/05	ATE	TP.A-092 TP.A-093	19,8			
Bora Sedan (1J2) 1,6 16V	05/00 – 05/05	ATE	TP.A-093	19,8			
Bora Sedan (1J2) 1,6 FSI	01/02 – 05/05	ATE	TP.A-093	19,8			
Bora Sedan (1J2) 1,8	10/98 – 05/05	ATE	TP.A-092 TP.A-093	19,8			

Марка автомобиля	Годы выпуска автомобиля	Передние колодки			Задние колодки		
		Тип тормозной системы	№ по каталогу	Толщина изделия, мм	Тип тормозной системы	№ по каталогу	Толщина изделия, мм
VOLKSWAGEN							
Bora Sedan (1J2) 1,8 4 motion	02/99 – 05/05	ATE	TP.A-092 TP.A-093	19,8			
Bora Sedan (1J2) 1,8 T	05/00 – 05/05	ATE	TP.A-093	19,8			
Bora Sedan (1J2) 1,9 SDI / TDI	10/98 – 05/05	ATE	TP.A-065 TP.A-092 TP.A-093	19,8			
Bora Sedan (1J2) 1,9 TDI 4 motion	02/99 – 05/05	ATE	TP.A-065 TP.A-092 TP.A-093	19,8			
Bora Sedan (1J2) 2,0	10/98 – 05/05	ATE	TP.A-065 TP.A-092 TP.A-093	19,8			
Bora Sedan (1J2) 2,0 4 motion	04/00 – 05/05	ATE	TP.A-093	19,8			
Caddy 1,0i All Models	96-	ATE	TPA-024025	17,3			
Caddy 1,4 D All Models	96-	ATE	TPA-024025	17,3			
Caddy 1,6 D All Models	82-92	ATE	TPA-024025	19,7			
Caddy 2,0 All Models	82-	ATE	TPA-024025	19,7			
Caddy Pick-Up 1,6 All Models	82-92	ATE	TPA-024025	19,7			
Caddy Pick-Up 1,8i All Models	82-92	ATE	TPA-024025	19,7			
Caddy Pick-Up 1,9 All Models	95-	GIR	TP.A-013	17,5			
Caddy II Box (9K9B) 1,4	11/95 – 01/04	GIR	TP.A-003	19,4			
Caddy II Box (9K9B) 1,6	11/95 – 05/97	GIR	TP.A-003	19,4			
Caddy II Box (9K9A, 9K9B) 1,9 D / SDI	11/95 – 01/04	GIR	TP.A-003	19,4			
Caddy III Box (2KA, 2KH) 1.4	03/04-	ATE	TP.A-092/ TP.A-093	19,8			
Caddy III Box (2KA, 2KH) 1.4 16V	05/06-	ATE	TP.A-092/ TP.A-093	19,8			
Caddy III Box (2KA, 2KH) 1.6	04/04-	ATE	TP.A-092/ TP.A-093	19,8			
Caddy III Box (2KA, 2KH) 1.9 TDI	04/04-	ATE	TP.A-092/ TP.A-093	19,8			
Caddy III Box (2KA, 2KH) 2.0 Eco Fuel	04/06	ATE	TP.A-092/ TP.A-093	19,8			
Caddy III Box (2KA, 2KH) 2.0 SDI	03/04-	ATE	TP.A-092/ TP.A-093	19,8			
Caddy III Box (2KA, 2KH) 2.0 TDI	09/07-	ATE	TP.A-092/ TP.A-093	19,8			
Caddy II Estate (9K9B) 1,4	11/95 – 01/04	GIR	TP.A-003	19,4			
Caddy II Estate (9K9B) 1,6	11/95 – 05/97	GIR	TP.A-003	19,4			

Марка автомобиля	Годы выпуска автомобиля	Передние колодки			Задние колодки		
		Тип тормозной системы	№ по каталогу	Толщина изделия, мм	Тип тормозной системы	№ по каталогу	Толщина изделия, мм
VOLKSWAGEN							
Caddy II Estate (9K9B) 1,9 D / SDI	11/95 – 01/04	GIR	TP.A-003	19,4			
Caddy III Estate (2KB, 2KJ) 1.4	03/04-	ATE	TP.A-092/ TP.A-093	19,8			
Caddy III Estate (2KB, 2KJ) 1.4 16V	05/06-	ATE	TP.A-092/ TP.A-093	19,8			
Caddy III Estate (2KB, 2KJ) 1.6	04/04-	ATE	TP.A-092/ TP.A-093	19,8			
Caddy III Estate (2KB, 2KJ) 1.9 TDI	04/04-	ATE	TP.A-092/ TP.A-093	19,8			
Caddy III Estate (2KB, 2KJ) 1.9 TDI 4 motion	05/08-	ATE	TP.A-092/ TP.A-093	19,8			
Caddy III Estate (2KB, 2KJ) 2.0 Eco Fuel	04/06-	ATE	TP.A-092/ TP.A-093	19,8			
Caddy III Estate (2KB, 2KJ) 2.0 JDI	03/04-	ATE	TP.A-092/ TP.A-093	19,8			
Caddy III Estate (2KB, 2KJ) 2.0 TDI	09/07-	ATE	TP.A-092/ TP.A-093	19,8			
Caddy II Pick-Up (9U7) (06/96012/00) 1.6	06/96-12/00	TRW	TP.A-092/ TP.A-093	19,8			
Caddy II Pick-Up (9U7) 1.9 D	06/96-12/00	TRW	TP.A-092/ TP.A-093	19,8			
Carat (32B) 1,6	08/80 – 03/88	ATE VAG	TP.A-001 TP.A-024/025	18,5 15,3			
Carat (32B) 1,8	12/83 – 03/88	VAG	TP.A-024/025	15,3			
Carat (32B) 1,9	01/81 – 07/83	VAG	TP.A-024/025	15,3			
Carat (32B) 2,0	08/83 – 03/88	VAG	TP.A-024/025	15,3			
Carat (32B) 2,2	01/85 – 03/88	VAG ATE	TP.A-024/025 TP.A-073	15,3 16,0 / 19,5	GIR	TP.A-014	15,0
Carat Estate (32B) 1,6	08/80 – 03/88	VAG	TP.A-024/025	15,3			
Carat Estate (32B) 1,8 Syncro	01/86 – 03/88	VAG ATE	TP.A-024/025 TP.A-073	15,3 16,0 / 19,5	GIR	TP.A-014	15,0
Carat Estate (32B) 1,9	01/81 – 07/83	VAG	TP.A-024/025	15,3			
Carat Estate (32B) 2,0 Syncro	05/84 – 03/88	VAG ATE	TP.A-024/025 TP.A-073	15,3 16,0 / 19,5	GIR	TP.A-014	15,0
Carat Estate (32B) 2,2	01/85 – 03/88	VAG ATE	TP.A-024/025 TP.A-073	15,3 16,0 / 19,5	GIR	TP.A-014	15,0
Carat Estate (32B) 2,2 Syncro	08/85 – 03/88	ATE	TP.A-073	16,0 / 19,5	GIR	TP.A-014	15,0
Carat Sedan (32B) 2,2	01/85 – 03/88	VAG	TP.A-024/025	15,3			

Марка автомобиля	Годы выпуска автомобиля	Передние колодки			Задние колодки		
		Тип тормозной системы	№ по каталогу	Толщина изделия, мм	Тип тормозной системы	№ по каталогу	Толщина изделия, мм
VOLKSWAGEN							
Caravelle 1,8	90-	GIR	TP.A-047	18,0			
Caravelle 1,9 D C, GL,S (ABS)	90-	GIR	TP.A-047	18,0			
Caravelle 2,0i (ABS)	90-	GIR	TP.A-047	18,0			
Caravelle 2,4D (ABS)	90-	GIR	TP.A-047	18,0			
Caravelle 2,5i (ABS)	90-	GIR	TP.A-047	18,0			
Caravelle III Bus 1,6 TD (TD Syncro)	08/84 – 07/92	GIR	TP.A-041	19,5			
Caravelle III Bus 1,7 D	10/86 – 07/92	GIR	TP.A-041	19,5			
Caravelle III Bus 1,9 D (Syncro)	08/82 – 07/92	GIR	TP.A-041	19,5			
Caravelle III Bus 2,1i (KAT / Syncro)	08/85 – 07/92	GIR	TP.A-041	19,5			
Corrado 1,8i 16V (ABS)	82-92	GIR	TR.A-003	16,5	GIR	TR.A-014	15,0
Corrado 1,8i 16V (ABS)	90-92	GIR	TR.A-003	16,5	GIR	TR.A-014	15,0
Corrado 1,8i 16 All Models	88-	GIR	TR.A-003	16,5	GIR	TR.A-014	15,0
Corrado 1,8i 16 All Models (ABS)	90-	GIR	TR.A-003	16,5	GIR	TR.A-014	15,0
Corrado 1,8i G60 (ABS)	90-	GIR	TR.A-003	16,5	GIR	TR.A-014	15,0
Corrado 1,8i Limited, G Lader (ABS)	88-91	GIR	TR.A-003	19,4			
Corrado 1,8i Limited, G Lader, G60 (ABS)	88-91	GIR	TR.A-003	19,4	GIR	TR.A-014	15,0
Corrado 2,0i 16V (ABS)	91-	GIR	TR.A-003	16,5	GIR	TR.A-014	15,0
Corrado 2,9i VR6 (ABS)	88-89	GIR	TR.A-003	16,5	GIR	TR.A-014	15,0
Corrado 2,9i VR6 (ABS)	90-	GIR	TR.A-003	19,4	GIR	TR.A-014	15,0
Corsar (32B) 1,6	08/80 – 03/88	ATE VAG	TP.A-001 TP.A-024/025	18,5 15,3			
Corsar (32B) 1,8	12/83 – 03/88	VAG	TP.A-024/025	15,3			
Corsar (32B) 1,9	01/81 – 07/83	VAG	TP.A-024/025	15,3			
Corsar (32B) 2,0	08/83 – 03/88	VAG	TP.A-024/025	15,3			
Corsar (32B) 2,2	01/85 – 03/88	VAG ATE	TP.A-024/025 TP.A-073	15,3 16,0 / 19,5	GIR	TP.A-014	15,0
Corsar Estate (32B) 1,6	08/80 – 03/88	VAG	TP.A-024/025	15,3			
Corsar Estate (32B) 1,8 Syncro	01/86 – 03/88	VAG ATE	TP.A-024/025 TP.A-073	15,3 16,0 / 19,5	GIR	TP.A-014	15,0
Corsar Estate (32B) 1,9	01/81 – 07/83	VAG	TP.A-024/025	15,3			
Corsar Estate (32B) 2,0 Syncro	05/84 – 03/88	VAG ATE	TP.A-024/025 TP.A-073	15,3 16,0 / 19,5	GIR	TP.A-014	15,0
Corsar Estate (32B) 2,2	01/85 – 03/88	VAG ATE	TP.A-024/025 TP.A-073	15,3 16,0 / 19,5	GIR	TP.A-014	15,0
Corsar Estate (32B) 2,2 Syncro	08/85 – 03/88	ATE	TP.A-073	16,0 / 19,5	GIR	TP.A-014	15,0

Марка автомобиля	Годы выпуска автомобиля	Передние колодки			Задние колодки		
		Тип тормозной системы	№ по каталогу	Толщина изделия, мм	Тип тормозной системы	№ по каталогу	Толщина изделия, мм
VOLKSWAGEN							
Corsar Sedan (32B) 2,2	01/85 – 03/88	VAG	TP.A-024/025	15,3			
Derby 0,9 GL,L	77-85	ATE	TR.A-001	15,0			
Derby 1,0 C	85-	ATE	TR.A-024	17,3			
Derby 1,0 C,CL,GL	84-85	ATE	TR.A-001	15,0			
Derby 1,1 C Formel E, CL, GL, C, GL	77-85	ATE	TR.A-001	15,0			
Derby 1,3 C, CL	85-	ATE	TR.A-024	17,3			
Derby 1,3 C,CL,GL,GLS,LS,S	77-85	ATE	TR.A-001	15,0			
Derby 1,3 D All Models	86-	ATE	TR.A-024	17,3			
Derby Sedan (9A4) 1,4	07/03 –	ATE	TP.A-065 TP.A-092 TP.A-093	19,8			
Derby Sedan (9A4) 1,4 TDI	07/03 –	ATE	TP.A-065 TP.A-092 TP.A-093	19,8			
Derby Sedan (9A4) 1,9 SDI	09/02 –	ATE	TP.A-065 TP.A-092 TP.A-093	19,8			
Derby Sedan (6KV2) 100 1,6	12/95 – 09/01				GIR	TP.A-014	15,0
Eurovan IV Box (70XA) 1,9 D / TD	07/90 – 04/03	GIR	TP.A-047 TP.A-048	18,0			
Eurovan IV Box (70XA) 2,0	07/90 – 04/03	GIR	TP.A-047 TP.A-048	18,0			
Eurovan IV Box (70XA) 2,4 D (Syncro)	07/90 – 04/03	GIR	TP.A-047 TP.A-048	18,0			
Eurovan IV Box (70XA) 2,5 (Syncro)	11/90 – 04/03	GIR	TP.A-047 TP.A-048	18,0			
Eurovan IV Box (70XA) 2,5 TDI (Syncro)	09/95 – 04/03	GIR	TP.A-047 TP.A-048	18,0			
Eurovan IV Box (70XA) 2,8 VR6	05/96 – 04/03	GIR	TP.A-047 TP.A-048	18,0			
Flight Sedan (6KV2) 100 1,6	12/95 – 09/01				GIR	TP.A-014	15,0
Fox (5Z1) (10/03-) 1.0	10/03-	ATE	TP.A-092/ TP.A-093	19,8			
Fox (5Z1) (10/03-) 1.2	04/05-	ATE	TP.A-092/ TP.A-093	19,8			
Fox (5Z1) (10/03-) 1.4	04/05-	ATE	TP.A-092/ TP.A-093	19,8			
Fox (5Z1) (10/03-) 1.4 TDI	04/05-	ATE	TP.A-092/ TP.A-093	19,8			
Fox (5Z1) (10/03-) 1.6	10/03-	ATE	TP.A-092/ TP.A-093	19,8			
Fox (5Z1) (10/03-) 1.6 Total Flex	10/03-	ATE	TP.A-092/ TP.A-093	19,8			
Fox (5Z1) (10/03-) 1.9 D	12/07-	ATE	TP.A-092/ TP.A-093	19,8			
Golf 1,0 C, CL, GL	83-87	ATE	TP.A-024	17,3			
Golf 1,0 CL, GL (ABC)	89-91	ATE	TP.A-024/025	19,7			

Марка автомобиля	Годы выпуска автомобиля	Передние колодки			Задние колодки		
		Тип тормозной системы	№ по каталогу	Толщина изделия, мм	Тип тормозной системы	№ по каталогу	Толщина изделия, мм
VOLKSWAGEN							
Golf 1,0 CL, GL	89-91	ATE	TP.A-024	17,3			
Golf 1,1	83-92	ATE	TPA-024025	19,7			
Golf 1,1	83-92	ATE	TP.A-024	17,3			
Golf 1,1 Formel E, CL Formel E,C,CL	74-83	ATE	TP.A-001	15,0			
Golf 1,1 C Formel E, C, L, CLGL	75-83	ATE	TP.A-001	15,0			
Golf 1,1 L, GL	75-83	ATE	TP.A-001	15,0			
Golf 1,3	83-92	ATE	TPA-024025	19,7			
Golf 1,3	83-92	ATE	TP.A-024	17,3			
Golf 1,3 All Models	89-90	ATE	TP.A-024	17,3			
Golf 1,3 C, CL, GL	83-92	ATE	TPA-024025	19,7			
Golf 1,3 C, CL, GL	83-92	ATE	TP.A-024	17,3			
Golf 1,3 L, GL, S, LS, GLS	75-83	ATE	TP.A-001	15,0			
Golf 1,3 GL	83-87	ATE	TPA-024025	15,3			
Golf 1,3 GLS, LS, S	78-81	ATE	TP.A-001	15,0			
Golf 1,5 C, LS, CL, GL, LX, GX, GLS	74-81	ATE	TP.A-001	15,0			
Golf 1,5 C, LS, CL, GL, LX, GX, GLS	81-83	ATE	TPA-024025	19,7			
Golf 1,5 GLS, LS, S	74-81	ATE	TP.A-001	18,5			
Golf 1,5 GLS, LS, S	74-81	ATE	TP.A-001	15,0			
Golf 1,5 GLS, LS, S	81-83	ATE	TPA-024025	19,7			
Golf 1,6 C, CL, LS, S (ABS)	92-93	ATE	TPA-024025	19,7			
Golf 1,6 C, CL, GL	83-86	ATE	TP.A-024	17,3			
Golf 1,6 C, CL, GL	86-91	ATE	TPA-024025	19,7			
Golf 1,6 CL, GL	83-86	ATE	TP.A-024	17,3			
Golf 1,6 CL, GL	86-91	ATE	TPA-024025	19,7			
Golf 1,6 GL	83-92	ATE	TPA-024025	15,3			
Golf 1,6 CLS, LS, S	74-81	ATE	TP.A-001	18,5			
Golf 1,6 GTi	75-81	ATE	TP.A-001	15,0			
Golf 1,6 GTi	81-83	ATE	TPA-024025	15,3			
Golf 1,6 GTi	79-81	ATE	TP.A-001	15,0			
Golf 1,6i GTi	81-83	ATE	TPA-024025	15,3			
Golf 1,6 GTi	74-76	ATE	TP.A-001	15,0			
Golf 1,6 S, LS, GLS	74-81	ATE	TP.A-001	15,0			
Golf 1,6 S, LS, GLS	81-83	ATE	TPA-024025	19,7			
Golf 1,8 C, CL, GL, GT	83-92	ATE	TPA-024025	19,7	GIR	TP.A-014	15,0
Golf 1,8 C, CL, GL, GT (ABS)	75-83	ATE	TPA-024025	15,3	GIR	TP.A-014	15,0

Марка автомобиля	Годы выпуска автомобиля	Передние колодки			Задние колодки		
		Тип тормозной системы	№ по каталогу	Толщина изделия, мм	Тип тормозной системы	№ по каталогу	Толщина изделия, мм
VOLKSWAGEN							
Golf 1,8 Carat, C, CL, GL, GT	83-92	ATE	TPA-024025	15,3	GIR	TP.A-014	15,0
Golf 1,8 CL, GL, GT	83-92	ATE	TPA-024025	15,3	GIR	TP.A-014	15,0
Golf 1,8 CL, GL, GT	83-92	ATE	TPA-024025	19,7	GIR	TP.A-014	15,0
Golf 1,8 GTi	81-91	ATE	TPA-024025	15,3			
Golf 1,8 GTi	83-92	ATE	TPA-024025	15,3	GIR	TP.A-014	15,0
Golf 1,8 GTi	75-81	ATE	TP.A-001	15,0			
Golf 1,8 GTi	81-83	ATE	TPA-024025	15,3			
Golf 1,8 GTi 16V	83-92	ATE	TPA-024025	15,3	GIR	TP.A-014	15,0
Golf 1,8 GTi 16V	83-92	GIR	TP.A-003	16,5	GIR	TP.A-014	15,0
Golf 1,8 GTi G60	83-92	GIR	TP.A-003	19,4	GIR	TP.A-014	15,0
Golf 1,8i C	83-85	ATE	TPA-024025	19,7			
Golf 1,8i C, CL, GT (ABS)	86-87	ATE	TPA-024025	15,3	GIR	TP.A-014	15,0
Golf 1,8i CL	83-91	ATE	TPA-024025	19,7			
Golf 1,8i CL, Carat	88-91	ATE	TPA-024025	19,7	GIR	TP.A-014	15,0
Golf 1,8i CL, GL, GT (ABS)	85-91	ATE	TPA-024025	19,7			
Golf 1,8i CL, GLi, GT, GTi	87-89	ATE	TPA-024025	19,7			
Golf 1,8i CL, GT, GTi, GTi Edition (ABS)	86-89	ATE	TPA-024025	15,3	GIR	TP.A-014	15,0
Golf 1,8i GTi	75-81	ATE	TP.A-001	15,0			
Golf 1,8i GTi (ABS)	81-83	ATE	TPA-024025	15,3			
Golf 1,8i GTi (ABS)	83-88	ATE	TPA-024025	19,7	GIR	TP.A-014	15,0
Golf 1,8i GTi 16V (ABS)	85-88	ATE	TPA-024025	15,3	GIR	TP.A-014	15,0
Golf 1,8i GTi 16V Edition (ABS)	88-	GIR	TP.A-003	19,4	GIR	TP.A-014	15,0
Golf 1,8i GTi 16V Edition (ABS)	89-90	GIR	TP.A-003	16,5	GIR	TP.A-014	15,0
Golf 1,8i GTi 16V GTi Edition (ABS)	88-	GIR	TP.A-003	16,5	GIR	TP.A-014	15,0
Golf 1,8i GTi G60 (ABS)	83-92	GIR	TP.A-003	16,5	GIR	TP.A-014	15,0
Golf 1,8i GTi GTi G60, GTi Edition (ABS)	89-91	ATE	TPA-024025	19,7	GIR	TP.A-014	15,0
Golf 1,8i GTi GTi G60, GTi Edition (ABS)	89-93	ATE	TPA-024025	15,3	GIR	TP.A-014	15,0
Golf 1,8i GTi GTi G60, GTi Edition	91	GIR	TP.A-003	19,4	GIR	TP.A-014	15,0
Golf 2,0	89-91	ATE	TPA-024025	19,7			
Golf 1,5 D GL, L, S	76-83	ATE	TP.A-001	15,0			
Golf 1,5 D, L, GL	76-83	ATE	TP.A-001	15,0			
Golf 1,6 C, CL, GL, GTD, Turbo	83-92	ATE	TPA-024025	19,7			

Марка автомобиля	Годы выпуска автомобиля	Передние колодки			Задние колодки		
		Тип тормозной системы	№ по каталогу	Толщина изделия, мм	Тип тормозной системы	№ по каталогу	Толщина изделия, мм
VOLKSWAGEN							
Golf 1,6 CL, GL, GTD, Turbo	83-92	ATE	TPA-024025	19,7			
Golf 1,6 D	83-92	ATE	TPA-024025	19,7			
Golf 1,6 D	83-92	ATE	TP.A-024	17,3			
Golf 1,6 D C Formel E, GL Formel E, CL	76-83	ATE	TP.A-001	15,0			
Golf 1,6 D C, CL, GL	76-83	ATE	TP.A-001	15,0			
Golf 1,6 D C, CL, GL	83-92	ATE	TPA-024025	19,7			
Golf 1,6 D C, CL, GL	83-92	ATE	TP.A-024	17,3			
Golf 1,6 D C, CL, Turbo GT	82-83	ATE	TPA-024025	19,7			
Golf 1,6 D CL, GL, Turbo GL (ABS)	89-91	ATE	TPA-024025	19,7			
Golf 1,6 D CT Turbo GLX, GTD	89-91	ATE	TPA-024025	19,7			
Golf 1,6 D L, GL, C, CL, GX	76-83	ATE	TP.A-001	15,0			
Golf 1,6 Turbo	83-92	ATE	TPA-024025	19,7			
Golf Cabrio 1,1 L, S, LS, GL, GLS	79-93	ATE	TP.A-001	15,0			
Golf Cabrio 1,3 L, S, LS, GL, GLS	79-93	ATE	TPA-024025	19,7			
Golf Cabrio 1,5, GL, GLS	79-83	ATE	TPA-024025	19,7			
Golf Cabrio 1,6	79-83	ATE	TPA-024025	19,7			
Golf Cabrio 1,6 GL	79-83	ATE	TPA-024025	19,7			
Golf Cabrio 1,6 GLi	79-93	ATE	TP.A-001	15,0			
Golf Cabrio 1,6 Gli	79-93	ATE	TPA-024025	15,3			
Golf Cabrio 1,8 GL Quartett	79-93	ATE	TPA-024025	15,3			
Golf Cabrio L/T 1.9 TDi ABS(+)	02/95-12/01	ATE	TPA-073	18,0			
Golf Caddy 1,5 All Models	82-83	ATE	TPA-024025	19,7			
Golf Caddy 1,6 All Models	82-92	ATE	TPA-024025	19,7			
Golf Caddy 1,8 All Models	82-83	ATE	TPA-024025	19,7			
Golf Estate (1J5) 1.4 16V	05/99-06/06	ATE	TP.A-092/ TP.A-093	19,8			
Golf Estate (1J5) 1.6	05/99-06/06	ATE	TP.A-092/ TP.A-093	19,8			
Golf Estate (1J5) 1.6 16V	02/00-06/06	ATE	TP.A-092/ TP.A-093	19,8			

Марка автомобиля	Годы выпуска автомобиля	Передние колодки			Задние колодки		
		Тип тормозной системы	№ по каталогу	Толщина изделия, мм	Тип тормозной системы	№ по каталогу	Толщина изделия, мм
VOLKSWAGEN							
Golf Estate (1J5) 1.8	01/02-06/06	ATE	TP.A-092/ TP.A-093	19,8			
Golf Estate (1J5) 1.8 4 motion	05/99-06/06	ATE	TP.A-092/ TP.A-093	19,8			
Golf Estate/Variant L/T 1.6	08/91-04/99	ATE	TP.A-073	18,0			
Golf Estate/Variant L/T 2.0	08/91-04/99	ATE	TP.A-073	18,0			
Golf Estate (Variant) L/T 2.0 ABS(-)	08/91-04/99	ATE	TP.A-073	18,0			
Golf Estate/Variant L/T 2.0 ABS(+)	08/91-04/99	ATE	TP.A-073	18,0			
Golf Estate (Variant) L/T ABS(+) 2.0	05/96-04/99	ATE	TP.A-073	18,0			
Golf Estate (Variant) L/T ABS(-) 2.0	05/96-04/99	ATE	TP.A-073	18,0			
Golf Syncro 1,84x4	86-92	ATE	TPA-024025	19,7			
Golf Syncro 1,8 4x4 G60	86-92	ATE	TP.A-003	19,4	GIR	TP.A-014	15,0
Golf Syncro 1,8 C, CL, GT, 4x4	86-92	ATE	TPA-025025	19,7			
Golf Van (Hatchback) L/T 2.0	08/91-09/97	ATE	TP.A-073	18,0			
Golf Van (Hatchback) L/T ABS(+) 2.0	08/91-09/97	ATE	TP.A-073	18,0			
Golf Van (Hatchback) L/T ABS(-) 2.0	08/91-09/97	ATE	TP.A-073	18,0			
Golf.. III 1,4i CL, GL	91-	GIR	TP.A-003	16,5			
Golf...III 1,4i CL	91-95	ATE	TPA-024025	19,7			
Golf...III 1,6 GT	91-	GIR	TP.A-003	16,5	GIR	TP.A-014	17,4
Golf...III 1,6 GT	91-	GIR	TP.A-003	19,4	GIR	TP.A-014	17,4
Golf...III 1,6i CL, GL (ABS)	91-	GIR	TP.A-003	16,5	GIR	TP.A-014	15,0
Golf...III 1,6i CL, GL	91-95	ATE	TPA-024025	19,7			
Golf...III 1,8 GT	91-	GIR	TP.A-003	16,5	GIR	TP.A-014	15,0
Golf...III 1,8i CL, GL, GT	91-	GIR	TP.A-003	16,5	GIR	TP.A-014	15,0
Golf...III 1,8i , GL, GT (ABS)	91-	GIR	TP.A-003	16,5	GIR	TP.A-014	15,0
Golf...III 1,8i , GTi (ABS)	91-	GIR	TP.A-003	16,5	GIR	TP.A-014	15,0
Golf...III 1,8i CL, GL	91-94	ATE	TPA-024025	19,7	GIR	TP.A-014	15,0
Golf...III 1,8i CL, GL	94-	GIR	TP.A-003	19,4	GIR	TP.A-014	15,0
Golf...III 1,8i GL	91-94	ATE	TPA-024025	19,7	GIR	TP.A-014	15,0
Golf...III 1,8i GL	94-	GIR	TP.A-003	19,4	GIR	TP.A-014	15,0
Golf...III 1,8i GT	94-	GIR	TP.A-003	16,5	GIR	TP.A-014	15,0
Golf...III 2,0 GL	91-94	GIR	TP.A-003	16,5	GIR	TP.A-014	15,0
Golf...III 2,0 GTi	91-	GIR	TP.A-003	16,5	GIR	TP.A-014	15,0
Golf...III 2,0 GTi 16V	91-	GIR	TP.A-003	16,5	GIR	TP.A-014	15,0
Golf...III 2,0i CL, GL, GT (ABS)	91-	GIR	TP.A-003	16,5			
Golf...III 2,8 VR6 (ABS)	91-	GIR	TP.A-003	16,5	GIR	TP.A-014	15,0
Golf...III 1,8 D,Turbo D	91-	ATE	TPA-024025	19,7			

Марка автомобиля	Годы выпуска автомобиля	Передние колодки			Задние колодки		
		Тип тормозной системы	№ по каталогу	Толщина изделия, мм	Тип тормозной системы	№ по каталогу	Толщина изделия, мм
VOLKSWAGEN							
Golf...III 1,9 D CL, GL	91-95	ATE	TPA-024025	19,7			
Golf...III 1,9 CL, GL, GT, Turbo	91-95	ATE	TPA-024025	19,7			
Golf...III 1,9 D C1 TDi, GL TDi, GT TDi	91-93	GIR	TP.A-003	16,5	GIR	TP.A-014	15,0
Golf...III 1,9 D CL, GL, GT	91-92	GIR	TP.A-003	16,5			
Golf...III 1,9 D GL, GL TDi, GTD	92-	ATE	TPA-024025	19,7			
Golf...III 1,9i D GL TDi, GL TDi, GT TDi (ABS)	93-	ATE	TPA-024025	19,7			
Golf...III 1,9i D C1 TDi, GL TDi, GT TDi (ABS)	93-	GIR	TP.A-003	16,5	GIR	TP.A-014	15,0
Golf...III 1,9i D CL, GL Eco, GL (ABS)	93-	ATE	TPA-024025	19,7			
Golf...III 1,9 D GTD (ABS)	94	GIR	TP.A-003	16,5			
Golf...III 1,9i LDi	91-	GIR	TP.A-003	19,4	GIR	TP.A-014	15,0
Golf...III Cabrio 1,6	93-	GIR	TP.A-003	19,4	GIR	TP.A-014	15,0
Golf...III Cabrio 1,8i	93-	GIR	TP.A-003	19,4	GIR	TP.A-014	15,0
Golf...III Cabrio 2,0i	93-	GIR	TP.A-003	16,5	GIR	TP.A-014	15,0
Golf...III Cabrio 1,9 TDi	93-	GIR	TP.A-003	19,4	GIR	TP.A-014	15,0
Golf...III Caddy 1,4 All Models	96-	GIR	TP.A-003	19,4			
Golf...III Caddy 1,9 All Models	96-	GIR	TP.A-003	19,4			
Golf...III Syncro 1,8	91-95	ATE	TPA-024025	19,7			
Golf...III Syncro 2,9 VR6	91-				GIR	TP.A-014	17,4
Golf...III Syncro 1,9 TDi	95-	GIR	TP.A-003	19,4	GIR	TP.A-014	17,4
Golf...III Variant 1,4i CL	93-95	ATE	TPA-024025	19,7			
Golf...III Variant 1,6	93-	GIR	TP.A-003	19,4	GIR	TP.A-014	17,4
Golf...III Variant 1,8i CL	93-	GIR	TP.A-003	19,4	GIR	TP.A-014	17,4
Golf...III Variant 1,8i GL, GT	93-	GIR	TP.A-003	19,4			
Golf...III Variant 2,0i GL	93-	GIR	TP.A-003	16,5	GIR	TP.A-014	17,4
Golf...III Variant 2,9 VR6	93-				GIR	TP.A-014	17,4
Golf...III Variant 1,9 D GL	93-	GIR	TP.A-003	19,4			
Golf...III Variant 1,9 D GL Turbodiesel	93-	GIR	TP.A-003	19,4			
Golf...III Variant 1,9 TDi	93-	GIR	TP.A-003	19,4	GIR	TP.A-014	17,4
Golf...Rallye All Models	89-91	GIR	TP.A-003	19,4	GIR	TP.A-014	15,0
Golf IV (1J1) 1.4 16V	08/97-06/05	ATE	TP.A-092/ TP.A-093	19,8			
Golf IV (1J1) 1.6, 14", 15"	08/97-06/05	ATE	TP.A-092/ TP.A-093	19,8			
Golf IV (1J1) 1.6 16V	02/00-06/05	ATE	TP.A-092/ TP.A-093	19,8			
Golf IV (1J1) 1.9 TDI	08/97-06/05	ATE	TP.A-092/ TP.A-093	19,8			
Golf IV (1J1) 1.9 TDI 4 motion	07/98-06/05	ATE	TP.A-092/ TP.A-093	19,8			
Golf IV (1J1) 2.0	07/98-06/05	ATE	TP.A-092/ TP.A-093	19,8			
Golf IV (1J1) 2.0 4 motion	10/00-06/05	ATE	TP.A-092/ TP.A-093	19,8			

Марка автомобиля	Годы выпуска автомобиля	Передние колодки			Задние колодки		
		Тип тормозной системы	№ по каталогу	Толщина изделия, мм	Тип тормозной системы	№ по каталогу	Толщина изделия, мм
VOLKSWAGEN							
Golf IV (1J1) 1,6 FSI	01/02 – 06/05	ATE	TP.A-093	19,8			
Golf IV (1J1) 1,8	08/97 – 06/05	ATE	TP.A-092 TP.A-093	19,8			
Golf IV (1J1) 1,8 4 motion	05/98 – 06/05	ATE	TP.A-065 TP.A-092 TP.A-093	19,8			
Golf IV (1J1) 1,8 T	08/97 – 06/05	ATE	TP.A-092 TP.A-093	19,8			
Golf IV (1J1) 1,9 SDI	08/97 – 06/05	ATE	TP.A-065 TP.A-092 TP.A-093	19,8			
Golf IV Cabrio (1E7) 1,6	06/98 – 06/02	GIR	TP.A-003	19,4	GIR	TP.A-014	15,0
Golf IV Cabrio (1E7) 1,8	06/98 – 06/02	GIR	TP.A-003	19,4	GIR	TP.A-014	15,0
Golf IV Cabrio (1E7) 1,9 TDI	06/98 – 06/02	GIR ATE ATE	TP.A-003 TP.A-065 TP.A-073	16,5 / 19,4 19,8 16,0 / 19,5	GIR	TP.A-014	15,0
Golf IV Cabrio (1E7) 2,0	06/98 – 06/02	GIR ATE	TP.A-003 TP.A-065	19,4 19,8	GIR	TP.A-014	15,0
Golf IV Estate (1J5) 1.4 16V (05/99-06/06)	11/03-	ATE	TP.A-092/ TP.A-093	19,8			
Golf IV Estate (1J5) 1.6 (05/99-06/06)	11/03-	ATE	TP.A-092/ TP.A-093	19,8			
Golf IV Estate (1J5) 1.6 16V (05/99-06/06)	11/03-	ATE	TP.A-092/ TP.A-093	19,8			
Golf IV Estate (1J5) 1.6 FSI (01/02-06/06)	11/03-	ATE	TP.A-092/ TP.A-093	19,8			
Golf IV Estate (1J5) 1.9 SDi (05/99-06/06)	11/03-	ATE	TP.A-092/ TP.A-093	19,8			
Golf IV Estate (1J5) 1.9 TDi (05/99-06/06)	11/03-	ATE	TP.A-092/ TP.A-093	19,8			
Golf IV Estate (1J5) 1.9 TDI Ø256,0 mm	03/03-	ATE	TP.A-092/ TP.A-093	19,8			
Golf IV Estate (1J5) 1.9 TDI (05/99-06/06) Ø280,0 mm	03/03-	ATE	TP.A-092/ TP.A-093	19,8			
Golf IV Estate (1J5) 1.9 TDI Ø288,0 mm	03/03-	ATE	TP.A-092/ TP.A-093	19,8			
Golf IV Estate (1J5) 1.9 TDI Ø280,0 mm	11/03-	ATE	TP.A-092/ TP.A-093	19,8			
Golf IV Estate (1J5) 1.9 TDI Ø288 mm	11/03-	ATE	TP.A-092/ TP.A-093	19,8			
Golf IV Estate (1J5) 2.0 (05/99-06/06)	11/03-	ATE	TP.A-092/ TP.A-093	19,8			
Golf IV Variant (1J5) 1,4 16V	05/99 – 06/06	ATE	TP.A-093	19,8			
Golf IV Variant (1J5) 1,6	05/99 – 06/06	ATE	TP.A-093	19,8			
Golf IV Variant (1J5) 1,6 16V	02/00 – 06/06	ATE	TP.A-093	19,8			

Марка автомобиля	Годы выпуска автомобиля	Передние колодки			Задние колодки		
		Тип тормозной системы	№ по каталогу	Толщина изделия, мм	Тип тормозной системы	№ по каталогу	Толщина изделия, мм
VOLKSWAGEN							
Golf IV Variant (1J5) 1,6 FSI	01/02 – 06/06	ATE	TP.A-093	19,8			
Golf IV Variant (1J5) 1,8 4 motion	05/99 – 06/06	ATE	TP.A-093	19,8			
Golf IV Variant (1J5) 1,9 TDI / SDI (4 motion)	05/99 – 06/06	ATE	TP.A-093	19,8			
Golf IV Variant (1J5) 2,0	05/99 – 06/06	ATE	TP.A-093	19,8			
Golf IV Variant (1J5) 2,0 4 motion	10/00 – 06/06	ATE	TP.A-093	19,8			
Golf IV Variant (1J5) 2,0 Bi-Fuel	02/02 – 06/06	ATE	TP.A-093	19,8			
Golf V (1K1) (10/03-) 1,0	08/05-	ATE	TP.A-092/ TP.A-093	19,8			
Golf V (1K1) (10/03-) 1.4 16V	-05/05	ATE	TP.A-092/ TP.A-093	19,8			
Golf V (1K1) 1.4 FSI	10/03-	ATE	TP.A-092/ TP.A-093	19,8			
Golf V (1K1) 1.4 TSI, Ø256 mm	11/05-	ATE	TP.A-092/ TP.A-093	19,8			
Golf V (1K1) 1.4 TSI, Ø280,0 mm	11/05-	ATE	TP.A-092/ TP.A-093	19,8			
Golf V (1K1) 1.6	01/04-	ATE	TP.A-092/ TP.A-093	19,8			
Golf V (1K1) 1.6 FSI Ø288,0 mm	10/03-	ATE	TP.A-092/ TP.A-093	19,8			
Golf V (1K1) 1.6 FSI Ø312,0 mm	10/03-	ATE	TP.A-092/ TP.A-093	19,8			
Golf V (1K1) (10/03-) 1.6 FSI Ø256,0 mm Ø280,0 mm	10/03-	ATE	TP.A-092/ TP.A-093	19,8			
Golf V (1K1) (10/03-) 1.8	08/05-	ATE	TP.A-092/ TP.A-093	19,8			
Golf V (1K1) (10/03-) 1,8 Hybnd	08/05-	ATE	TP.A-092/ TP.A-093	19,8			
Golf V (1K1) 2,0 SDI Ø 256 mm	01/04-	ATE	TP.A-092/ TP.A-093	19,8			
Golf V (1K1) 2.0 SDI	01/04-	ATE	TP.A-092/ TP.A-093	19,8			
Golf V (1K1) 2.0 TDI Ø 256 mm	10/03-	ATE	TP.A-092/ TP.A-093	19,8			
Golf V (1K1) 2.0 TDI Ø 280 mm	10/03-	ATE	TP.A-092/ TP.A-093	19,8			
Golf V (1K1) 2.0 TDI 16V	10/03-	ATE	TP.A-092/ TP.A-093	19,8			
Golf V (1K1) 2.0 TDI 16V 4 motion Ø256 mm	08/04-	ATE	TP.A-092/ TP.A-093	19,8			
Golf V (1K1) 2.0 TDI 16V 4 motion Ø280,0 mm	08/04-	ATE	TP.A-092/ TP.A-093	19,8			
Golf V (1K1) 2.0 TDI 4 motion Ø256 mm	08/04-	ATE	TP.A-092/ TP.A-093	19,8			

Марка автомобиля	Годы выпуска автомобиля	Передние колодки			Задние колодки		
		Тип тормозной системы	№ по каталогу	Толщина изделия, мм	Тип тормозной системы	№ по каталогу	Толщина изделия, мм
VOLKSWAGEN							
Golf V (1K1) 2.0 TDI 4 motion Ø280,0 mm	08/04-	ATE	TP.A-092/ TP.A-093	19,8			
Golf V (1K1) 2.5 FSI VR5	06/05-	ATE	TP.A-092/ TP.A-093	19,8			
Golf V (1K1) 3.2 Ø256 mm	09/05-	ATE	TP.A-092/ TP.A-093	19,8			
Golf V (1K1) 3.2 Ø280 mm	09/05-	ATE	TP.A-092/ TP.A-093	19,8			
Golf V (1K1) 3.2 R 32 4 motion Ø310,0 mm Ø345,0 mm	11/05-	ATE	TP.A-092/ TP.A-093	19,8			
Golf V (1K1) 1,9 TDI	10/03 – 11/08	ATE	TP.A-093	19,8			
Golf V (1K1) 1,9 TDI 4 motion	08/04 – 11/08	ATE	TP.A-093	19,8			
Golf V (1K1) 2,0 FSI	01/04 – 11/08	ATE	TP.A-093	19,8			
Golf V (1K1) 2,0 FSI 4 motion	08/04 – 11/08	ATE	TP.A-093	19,8			
Golf V (1K1) 2,0 GTI	10/04 – 02/09	ATE	TP.A-093	19,8			
Golf V Estate (1K5) 1.4	06/07-	ATE	TP.A-092/ TP.A-093	19,8			
Golf V Estate (1K5) 1.4 TSI	06/07-	ATE	TP.A-092/ TP.A-093	19,8			
Golf V Estate (1K5) 1.6	06/07-	ATE	TP.A-092/ TP.A-093	19,8			
Golf V Estate (1K5) 1.9 TDI	06/07-	ATE	TP.A-092/ TP.A-093	19,8			
Golf V Estate (1K5) 1.9 TDI 4 motion	01/08-	ATE	TP.A-092/ TP.A-093	19,8			
Golf V Estate (1K5) 2.0 TDI	06/07-	ATE	TP.A-092/ TP.A-093	19,8			
Golf V Estate (1K5) 2.0 TDI 16V	06/07-	ATE	TP.A-092/ TP.A-093	19,8			
Golf V Estate (1K5) 2.0	06/07-	ATE	TP.A-092/ TP.A-093	19,8			
Golf V Variant (1K5) 1,4	06/07 –	ATE	TP.A-093	19,8			
Golf V Variant (1K5) 1,4 TSI	06/07 –	ATE	TP.A-093	19,8			
Golf V Variant (1K5) 1,6	06/07 –	ATE	TP.A-093	19,8			
Golf V Variant (1K5) 1,9 TDI (4 motion)	06/07 –	ATE	TP.A-093	19,8			
Golf V Variant (1K5) 2,0	06/07 –	ATE	TP.A-093	19,8			
Golf V Variant (1K5) 2,0 TDI (16V)	06/07 –	ATE	TP.A-093	19,8			
Golf VI (5K1) 1.4	10/08-	ATE	TP.A-092/ TP.A-093	19,8			
Golf VI (5K1) 1.4 TSI	10/08-	ATE	TP.A-092/ TP.A-093	19,8			
Golf VI (5K1) 1.6	10/08-	ATE	TP.A-092/ TP.A-093	19,8			

Марка автомобиля	Годы выпуска автомобиля	Передние колодки			Задние колодки		
		Тип тормозной системы	№ по каталогу	Толщина изделия, мм	Тип тормозной системы	№ по каталогу	Толщина изделия, мм
VOLKSWAGEN							
Golf VI (5K1) 1.6 Bio Fuel	03/09-	ATE	TP.A-092/ TP.A-093	19,8			
Golf VI (5K1) 2.0 TDI	10/08-	ATE	TP.A-092/ TP.A-093	19,8			
Golf VI Variant (AJ5) 1,2 TSI	08/09 –	ATE	TP.A-093	19,8			
Golf VI Variant (AJ5) 1,4	07/09 –	ATE	TP.A-093	19,8			
Golf VI Variant (AJ5) 1,6	07/09 –	ATE	TP.A-093	19,8			
Golf VI Variant (AJ5) 1,6 TDI (4 motion)	07/09 –	ATE	TP.A-093	19,8			
Golf L/T 1.6	08/95-09/97	ATE	TP.A-073	18,0			
Golf L/T 1.8 GTi, ABS(+)	08/85-07/91	ATE	TP.A-073	18,0			
Golf L/T 1.8 GTi, ABS(+)	08/85-07/91	ATE	TP.A-073	18,0			
Golf L/T 1.8	08/91-09/97	ATE	TP.A-073	18,0			
Golf L/T 2.0	08/91-09/94	ATE	TP.A-073	18,0			
Golf L/T 2.0 ABS(+)	08/95-09/97	ATE	TP.A-073	18,0			
Golf L/T 1.9 TDi	08/95-09/97	ATE	TP.A-073	18,0			
Golf L/T 1.9 TDi, ABS(+)	08/95-09/97	ATE	TP.A-073	18,0			
Golf Plus (5M1, 521) 1.4 16V	01/05-	ATE	TP.A-092/ TP.A-093	19,8			
Golf Plus (5M1, 521) 1.4 FSI	07/05-05/06	ATE	TP.A-092/ TP.A-093	19,8			
Golf Plus (5M1, 521) 1.4 TSI	05/06-	ATE	TP.A-092/ TP.A-093	19,8			
Golf Plus (5M1, 521) 1.6	05/05-	ATE	TP.A-092/ TP.A-093	19,8			
Golf Plus (5M1, 521) 1.6 FSI	01/05-	ATE	TP.A-092/ TP.A-093	19,8			
Golf Plus (5M1, 521) 1.6 TDI	03/09-	ATE	TP.A-092/ TP.A-093	19,8			
Golf Plus (5M1, 521) 1.9 TDI	01/05-	ATE	TP.A-092/ TP.A-093	19,8			
Golf Plus (5M1, 521) 2.0 FSI	05/05-	ATE	TP.A-092/ TP.A-093	19,8			
Golf Plus (5M1, 521) 2.0 TDI	05/05-	ATE	TP.A-092/ TP.A-093	19,8			
Golf Plus (5M1, 521) 2.0 TDI 16V	01/05-	ATE	TP.A-092/ TP.A-093	19,8			
Jetta 1,0 CL	86-91	ATE	TP.A-024	17,3			
Jetta 1,0 CL (ABS)	86-91	ATE	TP.A-024025	19,7			
Jetta 1,1 C Formel E, CL Formel E, C, CL	81-83	ATE	TP.A-001	15,0			
Jetta 1,1 L, L Formel E, CL	79-83	ATE	TP.A-001	18,5			
Jetta 1,1 L, L Formel E, CL	83-	ATE	TP.A-024	17,3			
Jetta 1,3 C, CL, GL	81-83	ATE	TP.A-001	15,0			
Jetta 1,3 C, CL, GL	83-86	ATE	TP.A-024	17,3			
Jetta 1,3 CL, GL	87-91	ATE	TP.A-024	17,3			
Jetta 1,3 CL, L	79-81	ATE	TP.A-001	18,5			
Jetta 1,3i	87-88	ATE	TP.A-001	18,5			
Jetta 1,3 C, CL,GT	85-89	ATE	TP.A-024	17,3			

Марка автомобиля	Годы выпуска автомобиля	Передние колодки			Задние колодки		
		Тип тормозной системы	№ по каталогу	Толщина изделия, мм	Тип тормозной системы	№ по каталогу	Толщина изделия, мм
VOLKSWAGEN							
Jetta 2,0	83-86	ATE	TP.A-024	17,3			
Jetta 1,5 D	81-83	ATE	TP.A-001	15,0			
Jetta 1,6 D C, C Formel E, CL Formel E	81-83	ATE	TP.A-001	15,0			
Jetta 1,6 D C, C Formel E, CL Formel E	83-86	ATE	TP.A-024	17,3			
Jetta 1,6 D C, LS	81-83	ATE	TP.A-001	15,0			
Jetta 1,6 D CL, Carat, GL, GL Formel E	81-83	ATE	TP.A-001	15,0			
Jetta 1,6 D CL, Carat, GL, GL Formel E	83-	ATE	TP.A-024025	19,7			
Jetta 1,6 D CL, Carat, GL, GL Formel E	83-	ATE	TP.A-024	17,3			
Jetta 1,6 D GL (ABS)	87-89	ATE	TP.A-024025	19,7			
Jetta 1,6 D GT, GTD, L Formel E, Turbo (ABS)	83-85	ATE	TP.A-024	17,3			
Jetta 1,6 D GT, GTD, L Formel E, Turbo (ABS)	87-89	ATE	TP.A-024025	19,7			
Jetta 1,6 D Turbo CL, GL	83-89	ATE	TP.A-024025	19,7			
Jetta 1,6 D Turbo CL, GL (ABS)	89-91	ATE	TP.A-024025	19,7			
Jetta 1,6 D Turbo GT, GTD (ABS)	87-91	ATE	TP.A-024025	19,7			
Jetta 1,6 TD	83	ATE	TP.A-024025	19,7			
Jetta Synero 1,8i CL	86-	ATE	TP.A-024025	19,7			
Jetta L/T 1.8	08/85-07/92	ATE	TP.A-073	18,0			
Jetta L/T 1.8 ABS(-)	07/88-10/91	ATE	TP.A-073	18,0			
Jetta L/T 1.8 ABS(-)	08/88-10/91	ATE	TP.A-073	18,0			
Jetta I Sedan (1K2) 1,4 TSI	07/08 – 10/10	ATE	TP.A-093	19,8			
Jetta I Sedan (1K2) 1,6	10/05 – 10/10	ATE	TP.A-093	19,8			
Jetta I Sedan (1K2) 1,6 FSI	09/05 – 10/10	ATE	TP.A-093	19,8			
Jetta I Sedan (1K2) 1,6 TDI	06/09 – 10/10	ATE	TP.A-093	19,8			
Jetta I Sedan (1K2) 1,9 TDI	08/05 – 10/10	ATE	TP.A-093	19,8			
Jetta II Sedan (19E, 1G2, 165) 1,8	01/84 – 10/91				GIR	TP.A-014	15,0
Jetta II Sedan (19E, 1G2, 165) 1,8 16V	08/86 – 10/91	GIR ATE	TP.A-003 TP.A-073	16,5 16,0/19,5	GIR	TP.A-014	15,0
Jetta II Sedan (19E, 1G2, 165) 1,8 KAT	01/87 – 10/91	GIR ATE	TP.A-003 TP.A-073	16,5 16,0/19,5	GIR	TP.A-014	15,0
Jetta III (1K2) 1.4 TSI	07/06-	ATE	TP.A-073	18,0			
Jetta III (1K2) 1.6	10/05-	ATE	TP.A-073	18,0			
Jetta III (1K2) 1.6 FSI	09/05-	ATE	TP.A-073	18,0			
Jetta III (1K2) 1.9 TDI	08/05-	ATE	TP.A-073	18,0			
Jetta III (1K2) 2.6 FSI	01/06-	ATE	TP.A-073	18,0			

Марка автомобиля	Годы выпуска автомобиля	Передние колодки			Задние колодки		
		Тип тормозной системы	№ по каталогу	Толщина изделия, мм	Тип тормозной системы	№ по каталогу	Толщина изделия, мм
VOLKSWAGEN							
Jetta III (1H2) 1,4	11/91 – 09/98	VAG	TP.A-024/025	19,7			
Jetta III (1H2) 1,6	09/92 – 09/98	VAG ATE	TP.A-024/025 TP.A-073	19,7 16,0 / 19,5	GIR	TP.A-014	15,0
Jetta III (1H2) 1,8	11/91 – 09/98	VAG ATE	TP.A-024/025 TP.A-073	19,7 16,0 / 19,5	GIR	TP.A-014	15,0
Jetta III (1H2) 1,9 D / TD	11/91 – 09/98	GIR	TP.A-003	19,4	GIR	TP.A-014	15,0
Jetta III (1H2) 1,9 TDI	09/93 – 09/98	VAG ATE	TP.A-024/025 TP.A-073	19,7 16,0 / 19,5	GIR	TP.A-014	15,0
Jetta III (1H2) 2,0	11/91 – 09/98	GIR ATE	TP.A-003 TP.A-073	16,5 / 19,4 16,0 / 19,5	GIR	TP.A-014	15,0
Jetta III (1H2) 2,8 VR6	01/92 – 09/98				GIR	TP.A-014	15,0
Jetta IV (162) 1,4 TSI (Hybrid)	02/11 –	ATE	TP.A-065 TP.A-092 TP.A-093	19,8			
Jetta IV (162) 1,6	12/11 –	ATE	TP.A-093	19,8			
Jetta IV (162) 1,6 TDI	02/11 –	ATE	TP.A-093	19,8			
Jetta IV (162) 2,0 TDI / TSI	12/10 –	ATE	TP.A-065 TP.A-092 TP.A-093	19,8			
Jetta IV (1J2) 1,4 16V	03/00 – 05/05	ATE	TP.A-092 TP.A-093	19,8			
Jetta IV (1J2) 1,6	10/98 – 05/05	ATE	TP.A-092 TP.A-093	19,8			
Jetta IV (1J2) 1,6 16V	05/00 – 05/05	ATE	TP.A-093	19,8			
Jetta IV (1J2) 1,6 FSI	01/02 – 05/05	ATE	TP.A-093	19,8			
Jetta IV (1J2) 1,8	10/98 – 05/05	ATE	TP.A-092 TP.A-093	19,8			
Jetta IV (1J2) 1,8 4 motion	02/99 – 05/05	ATE	TP.A-065 TP.A-092 TP.A-093	19,8			
Jetta IV (1J2) 1,8 T	05/00 – 05/05	ATE	TP.A-093	19,8			
Jetta IV (1J2) 1,9 SDI / TDI	10/98 – 05/05	ATE	TP.A-065 TP.A-092 TP.A-093	19,8			
Jetta IV (1J2) 1,9 TDI 4 motion	02/99 – 05/05	ATE	TP.A-065 TP.A-092 TP.A-093	19,8			
Jetta IV (1J2) 2,0	10/98 – 05/05	ATE	TP.A-065 TP.A-092 TP.A-093	19,8			
Jetta IV (1J2) 2,0 4 motion	04/00 – 05/05	ATE	TP.A-093	19,8			
Jetta IV Estate (1J6) 1,4 16V	09/01 – 05/05	ATE	TP.A-092 TP.A-093	19,8			

Марка автомобиля	Годы выпуска автомобиля	Передние колодки			Задние колодки		
		Тип тормозной системы	№ по каталогу	Толщина изделия, мм	Тип тормозной системы	№ по каталогу	Толщина изделия, мм
VOLKSWAGEN							
Jetta IV Estate (1J6) 1,6	05/99 – 05/05	ATE	TP.A-093	19,8			
Jetta IV Estate (1J6) 1,6 16V	02/00 – 05/05	ATE	TP.A-093	19,8			
Jetta IV Estate (1J6) 1,6 FSI	01/02 – 05/05	ATE	TP.A-093	19,8			
Jetta IV Estate (1J6) 1,8 4 motion	05/99 – 05/05	ATE	TP.A-093	19,8			
Jetta IV Estate (1J6) 1,8 T	05/00 – 05/05	ATE	TP.A-093	19,8			
Jetta IV Estate (1J6) 1,9 TDI (4 motion)	05/99 – 05/05	ATE	TP.A-093	19,8			
Jetta IV Estate (1J6) 2,0	05/99 – 05/05	ATE	TP.A-093	19,8			
Jetta IV Estate (1J6) 2,0 4 motion	04/00 – 05/05	ATE	TP.A-093	19,8			
Jetta V / Bora III (1K2) 1,4 TSI	07/08 – 10/10	ATE	TP.A-093	19,8			
Jetta V / Bora III (1K2) 1,6	10/05 – 10/10	ATE	TP.A-093	19,8			
Jetta V / Bora III (1K2) 1,6 FSI	09/05 – 10/10	ATE	TP.A-093	19,8			
Jetta V / Bora III (1K2) 1,6 TDI	06/09 – 10/10	ATE	TP.A-093	19,8			
Jetta V / Bora III (1K2) 1,9 TDI	08/05 – 10/10	ATE	TP.A-093	19,8			
Jetta VI IV (162) 1,2 TSI	02/11 –	ATE	TP.A-093	19,8			
Jetta VI IV (162) 1,4 TSI (Hybrid)	04/11 –	ATE	TP.A-065 TP.A-092 TP.A-093	19,8			
Jetta VI IV (162) 1,6	12/11 –	ATE	TP.A-093	19,8			
Jetta VI IV (162) 1,6 TDI	02/11 –	ATE	TP.A-093	19,8			
Jetta VI IV (162) 2,0 TDI / TSI	10/10 –	ATE	TP.A-065 TP.A-092 TP.A-093	19,8			
Jetta VI Estate (AJ5) 1,2 TSI	08/09 –	ATE	TP.A-093	19,8			
Jetta VI Estate (AJ5) 1,4	07/09 –	ATE	TP.A-093	19,8			
Jetta VI Estate (AJ5) 1,6	07/09 –	ATE	TP.A-093	19,8			
Jetta VI Estate (AJ5) 1,6 TDI (4 motion)	07/09 –	ATE	TP.A-093	19,8			
Kombi V Box 1,9 TDI	04/03 – 11/09	ATE	TP.A-097	19,8	TRW	TP.A-111	17,5
Kombi V Box 2,0	11/03 –	ATE	TP.A-097	19,8	TRW	TP.A-111	17,5
Kombi V Box 2,0 BiTDI (4 motion)	09/09 –	ATE	TP.A-097	19,8	TRW	TP.A-111	17,5
Kombi V Box 2,0 TDI	09/09 –	ATE	TP.A-097	19,8	TRW	TP.A-111	17,5
Kombi V Box 2,0 TDI 4 motion	09/09 –	ATE	TP.A-097	19,8	TRW	TP.A-111	17,5
Kombi V Box 2,0 TSI	05/11 –	ATE	TP.A-097	19,8	TRW	TP.A-111	17,5
Kombi V Box 2,0 TSI 4 motion	07/11 –	ATE	TP.A-097	19,8	TRW	TP.A-111	17,5
Kombi V Box 2,5 TDI	04/03 – 11/09	ATE	TP.A-097	19,8	TRW	TP.A-111	17,5
Kombi V Box 2,5 TDI 4 motion	07/04 – 11/09	ATE	TP.A-097	19,8	TRW	TP.A-111	17,5
Kombi V Box 3,2 4 motion	11/03 – 11/09	ATE	TP.A-097	19,8	TRW	TP.A-111	17,5

Марка автомобиля	Годы выпуска автомобиля	Передние колодки			Задние колодки		
		Тип тормозной системы	№ по каталогу	Толщина изделия, мм	Тип тормозной системы	№ по каталогу	Толщина изделия, мм
VOLKSWAGEN							
LT 45 2,0 Karmann Mobil	75-83	ATE	TP.A-006	18,5			
LT 45 2,4 All Models, Sven Hedin	82-	ATE	TP.A-006	18,5			
LT 45 2,4 All Models, Sven Hedin	89-	PER	TP.A-034	18,0			
LT 45 2,4 D All Models urbo	88-	ATE	TP.A-006	18,5			
LT 45 2,4 D All Models Turbo	92-	PER	TP.A-034	18,0			
LT 45 2,4 D All Models Sven Hedin	82-	ATE	TP.A-006	18,5			
LT 45 2,4 D All Models Sven Hedin	89-	PER	TP.A-034	18,0			
LT 45 2,4i all Models	88-	ATE	TP.A-006	18,5			
LT 45 2,4i All Models	89-	PER	TP.A-034	18,0			
LT 50 2,4 All Models Sven Hedin	82-	ATE	TP.A-006	18,5			
LT 50 2,4i All Models Turbo	88-	ATE	TP.A-006	18,5			
LT 50 2,4 D All Models Sven Hedin	82-	ATE	TP.A-006	18,5			
LT 50 2,4i All Models	88-	ATE	TP.A-006	18,5			
LT 55 2,4 All Models, Sven Hedin	82-	ATE	TP.A-006	18,5			
LT 55 2,4 D All Models Turbo	88-	ATE	TP.A-006	18,5			
LT 55 2,4 D All Models, Sven Hedin	82-	ATE	TP.A-006	18,5			
LT 55 2,4i All Models	88-	ATE	TP.A-006	18,5			
LT 28-50 Box (281-363) 2,4	12/82 – 07/92	ATE	TP.A-006	18,5			
LT 28-50 Box (281-363) 2,4 D / TD	02/86 – 05/96	ATE	TP.A-006	18,5			
LT 28-50 Box (281-363) 2,4i	03/94 – 06/96	ATE	TP.A-006	18,5			
LT 28-50 Bus (281-363) 2,4	12/82 – 07/92	ATE	TP.A-006	18,5			
LT 28-50 Bus (281-363) 2,4 D / TD	12/82 – 06/96	ATE	TP.A-006	18,5			
LT 28-50 Bus (281-363) 2,4i	08/89 – 06/96	ATE	TP.A-006	18,5			
LT 28-35 I Box (281-363) 2,4	12/82 – 07/92	ATE	TP.A-006	18,5			
LT 28-35 I Box (281-363) 2,4 D / TD	08/88 – 05/96	ATE	TP.A-006	18,5			
LT 28-35 I Box (281-363) 2,4i	03/94 – 06/96	ATE	TP.A-006	18,5			
LT 28-35 I Bus (281-363) 2,4	12/82 – 07/92	ATE	TP.A-006	18,5			
LT 28-35 I Bus (281-363) 2,4 D / TD	12/82 – 06/96	ATE	TP.A-006	18,5			
LT 28-35 I Bus (281-363) 2,4i	08/89 – 06/96	ATE	TP.A-006	18,5			
LT 40-55 I Box (291-512) 2,4	12/82 – 07/92	ATE	TP.A-006	18,5			
LT 40-55 I Box (291-512) 2,4 D / TD	02/86 – 05/96	ATE	TP.A-006	18,5			
LT 40-55 I Box (291-512) 2,4i	01/93 – 06/96	ATE	TP.A-006	18,5			
LT 24-46 II Box (2DXOAE) 2.3	05/96-07/06	PE	TP.A-083	20,0			
LT 24-46 II Box (2DXOAE) 2,8 TDI	06/97-07/06	PE	TP.A-083	20,0			

Марка автомобиля	Годы выпуска автомобиля	Передние колодки			Задние колодки		
		Тип тормозной системы	№ по каталогу	Толщина изделия, мм	Тип тормозной системы	№ по каталогу	Толщина изделия, мм
VOLKSWAGEN							
LT 24-46 II Box (2DXOAE) 2.5 TDI	05/96-07/06	PE	TP.A-083	20,0			
LT 28-46 II Fletbed/Chassis (2DXOFE) 2,3	06/96-07/06	PE	TP.A-083	20,0			
LT 28-46 II Fletbed/Chassis (2DXOFE) 2,5 TDI	06/06-04/01 12/96-	PE	TP.A-083	20,0			
LT 28-46 II Fletbed/Chassis (2DXOFE) 2,8 TDI	06/97-07/06	PE	TP.A-083	20,0			
LT 28-35 II Bus (2DM) 2,3	05/96-07/06	PE	TP.A-083	20,0			
LT 28-35 II Bus (2DM) 2,5 TDi	05/96-07/06	PE	TP.A-083	20,0			
LT 28-35 II Bus 2,8 TDI (2DB, 2DE, 2DK)	01/99 – 06/06	PE	TP.A-083	23,0			
Multivan T5 (7HM, 7HF) (04/03-) 1.9 TDI 16" Ø294,0 mm	04/03-	ATE	TP.A-097	19,8	TRW	TP.A-111	17,5
Multivan T5 (7HM, 7HF) (04/03-) 1.9 TDI 16" Ø314 mm	04/03-	ATE	TP.A-097	19,8	TRW	TP.A-111	17,5
Multivan T5 (7HM, 7HF) 2.0	11/03-	ATE	TP.A-097	19,8	TRW	TP.A-111	17,5
Multivan T5 (7HM, 7HF) 2.5 TDi Ø294,0 mm	04/03-	ATE	TP.A-097	19,8	TRW	TP.A-111	17,5
Multivan T5 (7HM, 7HF) 2.5 TDI Ø314,0 mm	04/03-	ATE	TP.A-097	19,8	TRW	TP.A-111	17,5
Multivan T5 (7HM, 7HF) 2.5 TDi 4 motion 16" Ø294,0 mm	07/04-	ATE	TP.A-097	19,8	TRW	TP.A-111	17,5
Multivan T5 (7HM, 7HF) 2.5 TDi 4 motion 16" Ø314,0 mm	07/04-	ATE	TP.A-097	19,8	TRW	TP.A-111	17,5
Multivan T5 (7HM, 7HF) 3.2 4 motion	11/03-06/06				TRW	TP.A-111	17,5
Multivan T5 (7HM, 7HF) 3.2 V6 17" Ø294 mm	02/04-	ATE	TP.A-097	19,8	TRW	TP.A-111	17,5
Multivan T5 (7HM, 7HF) 3.2 V6 17" Ø314 mm	02/04-	ATE	TP.A-097	19,8	TRW	TP.A-111	17,5
Multivan T5 (7HM, 7HF) 3.2 V6 4 motion 17" Ø294 mm	07/04-	ATE	TP.A-097	19,8	TRW	TP.A-111	17,5
Multivan T5 17" Ø314 mm	07/04-				TRW	TP.A-111	17,5
Multivan T5 (7HM, 7HF) 1.9 TDI	04/03-				ATE	TP.A-97	18,8
Multivan T5 (7HM, 7HF) 2.0	11/03-				ATE	TP.A-97	18,8
Multivan T5 (7HM, 7HF) 2.5 TDI Ø308,0 mm	04/03-				ATE	TP.A-97	18,8
Multivan T5 (7HM, 7HF) 2.5 TDI Ø330,0 mm	04/03-				ATE	TP.A-97	18,8
Multivan T5 (7HM, 7HF) 3.2 4 motion	11/03-06/06				ATE	TP.A-97	18,8
Multivan T5 (7HM, 7HF) 3.2 V6, 17"	02/04-				ATE	TP.A-97	18,8
Multivan T5 (7HM, 7HF) 3.2 V6 4 motion 17"	07/04-				ATE	TP.A-97	18,8
Multivan T5 (7HM, 7HF) 2,0 BiTDI	09/09 –	ATE	TP.A-097	19,8	TRW	TP.A-111	17,5
Multivan T5 (7HM, 7HF) 2,0 BiTDI 4 motion	09/09 –	ATE	TP.A-097	19,8	TRW	TP.A-111	17,5
Multivan T5 (7HM, 7HF) 2,0 TDI	09/09 –	ATE	TP.A-097	19,8	TRW	TP.A-111	17,5
Multivan T5 (7HM, 7HF) 2,0 TDI 4 motion	09/09 –	ATE	TP.A-097	19,8	TRW	TP.A-111	17,5
Multivan T5 (7HM, 7HF) 2,0 TSI	05/11 –	ATE	TP.A-097	19,8	TRW	TP.A-111	17,5

Марка автомобиля	Годы выпуска автомобиля	Передние колодки			Задние колодки		
		Тип тормозной системы	№ по каталогу	Толщина изделия, мм	Тип тормозной системы	№ по каталогу	Толщина изделия, мм
VOLKSWAGEN							
Multivan T5 (7HM, 7HF) 2,0 TSI 4 motion	07/11 –	ATE	TP.A-097	19,8	TRW	TP.A-111	17,5
New Beetle (9C1, 1C1) 1.4	11/01-	ATE	TP.A-092/ TP.A-093	19,8			
New Beetle (9C1, 1C1) 1.6	10/99-	ATE	TP.A-092/ TP.A-093	19,8			
New Beetle (9C1, 1C1) 1.9 TDI	01/98-	ATE	TP.A-092/ TP.A-093	19,8			
New Beetle (9C1, 1C1) 2.0	01/98-	ATE	TP.A-092/ TP.A-093	19,8			
New Beetle (9C1, 1C1) 2.5	07/05-	ATE	TP.A-092/ TP.A-093	19,8			
New Beetle Convertible (1J7) 1.4	01/03-	ATE	TP.A-092/ TP.A-093	19,8			
New Beetle Convertible (1J7) 1.6	01/03-	ATE	TP.A-092/ TP.A-093	19,8			
New Beetle Convertible (1J7) 1.8 T Ø280,0 mm	01/03-	ATE	TP.A-092/ TP.A-093	19,8			
New Beetle Convertible (1J7) 1.8 T Ø288,0 mm	01/03-	ATE	TP.A-092/ TP.A-093	19,8			
New Beetle Convertible (1J7) 1.9 TDI	06/03-	ATE	TP.A-092/ TP.A-093	19,8			
New Beetle Convertible 2.0	09/02-	ATE	TP.A-092/ TP.A-093	19,8			
New Beetle Convertible 2.5	07/05-	ATE	TP.A-092/ TP.A-093	19,8			
Novo Fusca (5C1) 1,2 TSI	07/11 –	ATE	TP.A-065 TP.A-092 TP.A-093	19,8			
Novo Fusca (5C1) 1,4 TSI	04/11 –	ATE	TP.A-065 TP.A-092 TP.A-093	19,8			
Novo Fusca (5C1) 1,6 TDI	10/11 –	ATE	TP.A-065 TP.A-092 TP.A-093	19,8			
Novo Fusca (5C1) 2,0 TDI / TSI	04/11 –	ATE	TP.A-065 TP.A-092 TP.A-093	19,8			
Novo Fusca (5C1) 2,5	04/11 –	ATE	TP.A-065 TP.A-092 TP.A-093	19,8			
Novo Fusca (9C1, 1C1) 1,4	11/01 –	ATE	TP.A-093	19,8			
Novo Fusca (9C1, 1C1) 1,6	10/99 –	ATE	TP.A-093	19,8			
Novo Fusca (9C1, 1C1) 1,9 TDI	01/98 –	ATE	TP.A-065 TP.A-092 TP.A-093	19,8			
Novo Fusca (9C1, 1C1) 2,0	01/98 –	ATE	TP.A-065 TP.A-092 TP.A-093	19,8			
Novo Fusca (9C1, 1C1) 2,5	07/05 –	ATE	TP.A-093	19,8			

Марка автомобиля	Годы выпуска автомобиля	Передние колодки			Задние колодки		
		Тип тормозной системы	№ по каталогу	Толщина изделия, мм	Тип тормозной системы	№ по каталогу	Толщина изделия, мм
VOLKSWAGEN							
Passat Variant 1,9 S, C5, CL, CL5, GL, GL5, GLS	80-83	ATE	TPA-024025	15,3			
Passat Variant 1,9 LS, LS5, S5, L5	80-83	ATE	TPA-024025	15,3			
Passat Variant 2,0 16V	93-				GIR	TP.A-014	17,4
Passat Variant 2,0 All Models	99-91	GIR	TP.A-003	19,4			
Passat Variant 2,0 GT 16V	88-	GIR	TP.A-003	16,5	GIR	TP.A-014	15,0
Passat Variant 2,0i 16V	89-	GIR	TP.A-003	16,5			
Passat Variant 2,0i 16V CL, GL, GT, GLS (ABS)	84-93	GIR	TP.A-003	16,5	GIR	TP.A-014	15,0
Passat Variant 2,0 GL, GLi, GT	83-86	ATE	TPA-024025	15,3			
Passat Variant 2,0i GT (ABS)	84-	GIR	TP.A-003	16,5	GIR	TP.A-014	15,0
Passat Variant 2,0i GT 16V	88-	GIR	TP.A-003	16,5	GIR	TP.A-014	15,0
Passat Variant 2,0i Trend, Trophy, CL, CL5, GL	86-89	ATE	TPA-024025	15,3			
Passat Variant 2,0i Trend, Trophy, CL, CL5, (ABS)	84-	GIR	TP.A-003	16,5	GIR	TP.A-014	15,0
Passat Variant 2,1i 5S, C5, CL5, GL5, GLS5	80-83	ATE	TPA-024025	15,3			
Passat Variant 2,1i LS5, S5	80-83	ATE	TPA-024025	15,3			
Passat Variant 2,2 GTS	80-88	GIR	TP.A-003	16,5	GIR	TP.A-014	15,0
Passat Variant 2,2i C, CL, GL, GT (ABS)	84-88	GIR	TP.A-003	16,5	GIR	TP.A-014	15,0
Passat Variant 2,2i C, CL, GL, GT	84-88	GIR	TP.A-003	16,5			
Passat Variant 2,3i CL, Carat, GL, GT (ABS)	84-86	GIR	TP.A-003	16,5	GIR	TP.A-014	15,0
Passat Variant 2,4i 16V	89-	GIR	TP.A-003	16,2			
Passat Variant 2,8 GL, GT, VR6	93-				GIR	TP.A-014	17,4
Passat Variant 2,8i VR6 (ABS)	94-	GIR	TP.A-003	19,4	GIR	TP.A-014	15,0
Passat Variant 2,8i VR6, Executive (ABS)	88-89	GIR	TP.A-003	16,5	GIR	TP.A-014	15,0
Passat Variant 1,5 D GL, GLD, L, LD	77-80	ATE	TR.A-001	18,5			
Passat Variant 1,5 D GL, GLD, L, LD	78-80	ATE	TR.A-001	15,0			
Passat Variant 1,6 Arena, C, CL, GL, GLD, LD	85-88	ATE	TPA-024025	19,7			
Passat Variant 1,6D CL, GL, GT, Turbo CL (ABS)	88-92	GIR	TP.A-003	19,4	GIR	TP.A-014	15,0
Passat Variant 1,6D CL, GL, GT, Turbo CL	88-93	GIR	TP.A-003	19,4	GIR	TP.A-014	15,0
Passat Variant 1,6 D GL, GLD, L, LD, Turbo CL	81-84	ATE	TP.A-001	15,0			
Passat Variant 1,6 D L, Turbo, Turbo C, Turbo CL	83-89	ATE	TPA-024025	19,7			
Passat Variant 1,6 D Turbo GL	81-84	ATE	TP.A-001	15,0			
Passat Variant 1,6 D Turbo GL, Turbo GT	88-89	GIR	TP.A-003	16,5			
Passat Variant 1,6 D Turbo GL, Turbo GT	89-	GIR	TP.A-003	19,4			

Марка автомобиля	Годы выпуска автомобиля	Передние колодки			Задние колодки		
		Тип тормозной системы	№ по каталогу	Толщина изделия, мм	Тип тормозной системы	№ по каталогу	Толщина изделия, мм
VOLKSWAGEN							
Passat Estate (3A5, 35I) 1.8	02/88-05/97	TRW	TP.A-073	16,0			
Passat Estate (3A5, 35I) 1,8 16V	04/88-12/89	TRW	TP.A-073	16,0			
Passat Estate (3A5, 35I) 1,9 TDi	04/88-05/97	TRW	TP.A-073	16,0			
Passat Estate (3A5, 35I) 2,0	04/88-05/97	TRW	TP.A-073	16,0			
Passat Estate (3A5, 35I) 2,0 16V	01/90-	TRW	TP.A-073	16,0			
Passat Estate (3A5, 35I) 2,0 Syncro	09/89-05/97	TRW	TP.A-073	16,0			
Passat Estate (3C5) 3,2 FSI 4 motion	08/05-	ATE	TP.A-092/ TP.A-093	19,8			
Passat (3C2) 3.2 FSI 4 motion	11/05-	ATE	TP.A-092/ TP.A-093	19,8			
Passat (3C2) 3.6 FSi	06/05-07/07	ATE	TP.A-092/ TP.A-093	19,8			
Phaeton (3D_) 3,0 V6 TDI 4 motion	09/04 –				TRW	TP.A-111	17,5
Phaeton (3D_) 3,2 V6	04/02 –				TRW	TP.A-111	17,5
Phaeton (3D_) 3,2 V6 4 motion	02/04 –				TRW	TP.A-111	17,5
Phaeton (3D_) 4,2 V8 4 motion	05/03 –				TRW	TP.A-111	17,5
Phaeton (3D_) 5,0 V10 TDI 4 motion	11/02 –				TRW	TP.A-111	17,5
Phaeton (3D_) 6,0 W12 4 motion	04/02 –				TRW	TP.A-111	17,5
Phaeton Sedan (3D_) 3,0 V6 TDI 4 motion	09/04 –				TRW	TP.A-111	17,5
Phaeton Sedan (3D_) 3,2 V6	04/02 –				TRW	TP.A-111	17,5
Phaeton Sedan (3D_) 3,2 V6 4 motion	02/04 –				TRW	TP.A-111	17,5
Phaeton Sedan (3D_) 4,2 V8 4 motion	05/03 –				TRW	TP.A-111	17,5
Phaeton Sedan (3D_) 5,0 V10 TDI 4 motion	11/02 –				TRW	TP.A-111	17,5
Phaeton Sedan (3D_) 6,0 W12 4 motion	04/02 –				TRW	TP.A-111	17,5
Polo 0,9 CL, GL, GS, L	75-81	ATE	TP.A-001	15,0			
Polo 1,0 CL	81-82	ATE	TP.A-001	15,0			
Polo 1,0i All Models	90-92	ATE	TP.A-024	17,3			
Polo 1,1 C, CL, GL, GLS, LS, S	75-83	ATE	TP.A-001	15,0			
Polo 1,3 All Models	83-84	ATE	TP.A-001	15,0			
Polo 1,3 All Models	90-92	ATE	TP.A-024	17,3			
Polo 1,3 CL, GT	90-92	ATE	TP.A-024	17,3			
Polo 1,3 D All Models	85-90	ATE	TP.A-024	17,3			
Polo 1,3i CL, GT	85-92	ATE	TP.A-024	17,3			
Polo 1,3i CL, GT	92-	ATE	TP.A-024025	7,3			
Polo 1,3i G40	85-	ATE	TP.A-024025	15,3			
Polo 1,3i G40	95-	ATE	TP.A-024025	17,3			
Polo 1,3i GT G40	85-	ATE	TP.A-024025	15,3			
Polo 1,3i GTi GT	95-	TE	TP.A-024025	17,3			
Polo 1,6 100PS Basic, CL, Confort (ABS)	96-	GIR	TP.A-002	16,5			

Марка автомобиля	Годы выпуска автомобиля	Передние колодки			Задние колодки		
		Тип тормозной системы	№ по каталогу	Толщина изделия, мм	Тип тормозной системы	№ по каталогу	Толщина изделия, мм
VOLKSWAGEN							
Polo 1,6 Basic, Cjnfort, GL, GLX	94-95	ATE	TPA-024025	17,3			
Polo 1,8 CL, Confort, Plus, L, Swiss, Special (ABS)	96-	GIR	TP.A-003	16,5			
Polo 1.8 GTI	09/05-	ATE	TP.A-092/ TP.A-093	19,8			
Polo 1,4 D All Models	87-	ATE	TP.A-024	17,3			
Polo 1,9 D Basic, Confort, Sport, Plus (ABS)	96-	ATE	TPA-024025	17,3			
Polo Classic 1,0 C, C Classic, CL, GL, GT	81-84	ATE	TP.A-001	15,0			
Polo Classic 1,0 C, C Classic, CL, GL, GT	85-	ATE	TP.A-024	17,3			
Polo Classic 1,1 C Classic Formel E, CL, Classic	81-84	ATE	TP.A-001	15,0			
Polo Classic 1,1 CL Classic GL Formel E, LS	75-83	ATE	TP.A-001	15,0			
Polo Classic 1,3 Boulevard, C, Classic, CL Class	75-81	ATE	TP.A-001	15,0			
Polo Classic 1,3 Boulevard, C, Classic, CL Class	85-	ATE	TP.A-024	17,3			
Polo Classic 1,3 CL Classic, GT	81-84	ATE	TP.A-001	15,0			
Polo Classic 1,3 CL Classic, GT	85-	ATE	TP.A-024	17,3			
Polo Classic 1,3 Fox, GL, GL Classic, GLS, LS	83-	ATE	TP.A-001	15,0			
Polo Classic 1,3 Fox, GL, GL Classic, GLS, LS	86-	ATE	TP.A-024	17,3			
Polo Classic 1,3, GL, Classic	83-84	ATE	TP.A-001	15,0			
Polo Classic 1,6 100PS, Basic, CL, Confort (Sedan)	95-01	GIR	TP.A-003	19,4	GIR	TP.A-014	15,0
Polo 0,9 Coupe	81-84	ATE	TP.A-001	15,0			
Polo 0,9 Coupe	85-	ATE	TP.A-024	17,3			
Polo 1,0 Coupe	81-84	ATE	TP.A-001	15,0			
Polo 1,0 Coupe	85-	ATE	TP.A-024	17,3			
Polo 1,4 D Coupe	85-	ATE	TP.A-024	17,3			
Polo (6N2) 1.9 D; Ø239 mm Ø256 mm	10/99-09/01	ATE	TP.A-092/ TP.A-093	19,8			
Polo (6R_) 1.2	06/09-	ATE	TP.A-092/ TP.A-093	19,8			
Polo (6R_) 1.4	06/09-	ATE	TP.A-092/ TP.A-093	19,8			
Polo 1.6 TDi	06/09-	ATE	TP.A-092/ TP.A-093	19,8			
Polo (9N_) 1.2	01/02-	ATE	TP.A-092/ TP.A-093	19,8			

Марка автомобиля	Годы выпуска автомобиля	Передние колодки			Задние колодки		
		Тип тормозной системы	№ по каталогу	Толщина изделия, мм	Тип тормозной системы	№ по каталогу	Толщина изделия, мм
VOLKSWAGEN							
Polo (9N_) 1.2 12V	10/01-	ATE	TP.A-092/ TP.A-093	19,8			
Polo (9N_) 1.4 16V	10/01-	ATE	TP.A-092/ TP.A-093	19,8			
Polo (9N_) 1.4 FSI	02/02-07/06	ATE	TP.A-092/ TP.A-093	19,8			
Polo (9N_) 1.4 TDI	10/01-	ATE	TP.A-092/ TP.A-093	19,8			
Polo (9N_) 1.6	08/02-05/05	ATE	TP.A-092/ TP.A-093	19,8			
Polo (9N_) 1.6 16V	05/06-	ATE	TP.A-092/ TP.A-093	19,8			
Polo (9N_) 1.8 GTI Cup Edition	05/06-	ATE	TP.A-092/ TP.A-093	19,8			
Polo (9N_) 1.9 SDI	10/01-	ATE	TP.A-092/ TP.A-093	19,8			
Polo (9N_) 1.9 TDI	10/01-	ATE	TP.A-092/ TP.A-093	19,8			
Polo (9N2) 1.9 D	10/99-09/01	ATE	TP.A-092/ TP.A-093	19,8			
Polo (6R_) (06/09-) 1.2	06/09-	ATE	TP.A-092/ TP.A-093	19,8			
Polo (6R_) 1.4	06/09-	ATE	TP.A-092/ TP.A-093	19,8			
Polo (6R_) 1.6 TDI	06/09-	ATE	TP.A-092/ TP.A-093	19,8			
Polo (6R_) 1.2 TSI	11/09-	ATE	TP.A-092/ TP.A-093	19,8			
Polo (6R_) 1.2	06/09-	ATE	TP.A-092/ TP.A-093	19,8			
Polo (6R_) 1.4	06/09-	ATE	TP.A-092/ TP.A-093	19,8			
Polo (6R_) 1.6 TDI	06/09-	ATE	TP.A-092/ TP.A-093	19,8			
Polo (6R_) 1.2 TSI	11/09-	ATE	TP.A-092/ TP.A-093	19,8			
Polo (6R_) 1.2	06/09-	ATE	TP.A-092/ TP.A-093	19,8			
Polo (6R_) 1.4	06/09-	ATE	TP.A-092/ TP.A-093	19,8			
Polo (6R_) 1,4 BiFuel	03/10 – 01/11	ATE	TP.A-065 TP.A-092 TP.A-093	19,8			
Polo (6R_) 1,4 TSI	10/12 –	ATE	TP.A-065 TP.A-092 TP.A-093	19,8			
Polo (6R_) 1,6 BiFuel	01/11 –	ATE	TP.A-065 TP.A-092 TP.A-093	19,8			
Polo 1.6 TDI	06/09-	ATE	TP.A-092/ TP.A-093	19,8			

Марка автомобиля	Годы выпуска автомобиля	Передние колодки			Задние колодки		
		Тип тормозной системы	№ по каталогу	Толщина изделия, мм	Тип тормозной системы	№ по каталогу	Толщина изделия, мм
VOLKSWAGEN							
Rabbit V (1K1) 1,4 16V	10/03 – 11/08	ATE	TP.A-093	19,8			
Rabbit V (1K1) 1,4 FSI	10/03 – 07/06	ATE	TP.A-093	19,8			
Rabbit V (1K1) 1,4 TSI	11/05 – 11/08	ATE	TP.A-093	19,8			
Rabbit V (1K1) 1,6	01/04 – 11/08	ATE	TP.A-093	19,8			
Rabbit V (1K1) 1,6 FSI	10/03 – 07/08	ATE	TP.A-093	19,8			
Rabbit V (1K1) 1,9 TDI (4 motion)	10/03 – 11/08	ATE	TP.A-093	19,8			
Rabbit V (1K1) 2,0 FSI (4 motion)	01/04 – 11/08	ATE	TP.A-093	19,8			
Rabbit V (1K1) 2,0 GTI / SDI	10/04 – 02/09	ATE	TP.A-093	19,8			
Rabbit V (1K1) 2,0 TDI (16V)	10/03 – 11/08	ATE	TP.A-093	19,8			
Rabbit V (1K1) 2,0 TDI 4 motion (16V 4 motion)	08/04 – 11/08	ATE	TP.A-093	19,8			
Rabbit V (1K1) 3,2 R32 4 motion	11/05 – 11/08	ATE	TP.A-093	19,8			
Santana 1,3 CL, CX, CL Formel E	80-81	ATE	TP.A-001	15,0			
Santana 1,3 CL, CX, CL Formel E	81-86	ATE	TPA-024025	19,7			
Santana 1,6 CL Formel E, CX, GL, CL Formel	80-88	ATE	TPA-024025	19,7			
Santana 1,6 GX Formel E, GX, LX	80-88	ATE	TPA-024025	19,7			
Santana 1,6i CX	80-88	ATE	TPA-024025	19,7			
Santana 1,8 CX, GX, LX	80-88	ATE	TPA-024025	19,7			
Santana 1,8i CX, GX, LX, LX Formel E	80-88	ATE	TPA-024025	19,7			
Santana 1,9 CL5, GL5, GX5, LX5	80-88	ATE	TPA-024025	15,3			
Santana 1,9 CL5, GL5, GX5, LX5	80-88	ATE	TPA-024025	19,7			
Santana 2,0i GX5, LX5	80-88	ATE	TPA-024025	15,3	GIR	TP.A-007	16,6
Santana 2,1i GL5, GX5, LX5	81-85	ATE	TPA-024025	15,3			
Santana 1,6 D C, Turbo GX, CL, CX, GX	80-88	ATE	TPA-024025	19,7			
Santana 1,6 D Turbo C, CL, GL, LX	82-85	ATE	TPA-024025	19,7			
Scirocco 1,1 L, GL, GT, TS	76-81	ATE	TP.A-001	15,0			

Марка автомобиля	Годы выпуска автомобиля	Передние колодки			Задние колодки		
		Тип тормозной системы	№ по каталогу	Толщина изделия, мм	Тип тормозной системы	№ по каталогу	Толщина изделия, мм
VOLKSWAGEN							
Scirocco 1,1 L, GL, GT, TS	78-81	ATE	TPA-024025	19,7			
Scirocco 1,3 L, CL, GL, GT	76-81	ATE	TP.A-001	15,0			
Scirocco 1,3 L, CL, GL, GT	78-81	ATE	TPA-024025	19,7			
Scirocco 1,3 L, CL, GL, GT	79-80	ATE	TP.A-001	18,5			
Scirocco 1,5 CL, GL, GT, S	81-83	ATE	TPA-024025	19,7			
Scirocco 1,5 GL, GT, S	79-80	ATE	TP.A-001	18,5			
Scirocco 1,6 CL, GL, GT, GTL, LS, S, TS	81-86	ATE	TPA-024025	19,7			
Scirocco 1,6 GL, Gli, GTi, GLS, GT, GTL	76-81	ATE	TP.A-001	18,5			
Scirocco 1,6 GL, Gli, GTi, GLS, GT, GTL	76-81	ATE	TP.A-001	15,0			
Scirocco 1,6 GLi, GTi	78-80	ATE	TP.A-001	15,0			
Scirocco 1,6 GLi, GTi	78-81	ATE	TPA-024025	15,3			
Scirocco 1,8 All Models	83-92	ATE	TPA-024025	15,3			
Scirocco 1,8i 16V GT	89-	GIR	TP.A-003	16,5			
Scirocco 1,8i 16V GT, GTX	84-89	GIR	TP.A-003	16,5	GIR	TP.A-014	15,0
Scirocco 1,8i Gli, GTi, Storm, GTL, GTX	82-90	ATE	TPA-024025	15,3			
Scirocco 1,8i White Cat	84-86	ATE	TPA-024025	15,3			
Scirocco (53B) 1.8 16V	10/85-07/92	TRW	TP.A-073	16,0	GIR	TP.A-014	15,0
Scirocco (53B) 1.8 16V	10/85-07/92	TRW	TP.A-073	16,0			
Sharan 1,9 TDi	95-	ATE	TP.A-019	19,5	GIR	TP.A-014	17,4
Sharan 2,0	95-	ATE	TP.A-019	19,5	GIR	TP.A-014	17,4
Sharan 2,8 VR6	95-	ATE	TP.A-019	19,5	GIR	TP.A-014	17,4
Sharan (7M8, 7M9, 7M6) 1,8 T 20V	09/97 – 03/10	ATE	TP.A-019	19,5			
Sharan (7M8, 7M9, 7M6) 1,9 TDI 4 motion	04/00 – 03/10	ATE	TP.A-019	19,5			
Transporter 1.6D (T2) 54/73	86-87	GIR	TP.A-041	19,5			
Transporter 1.8 Diesel (T2) 42/75	86-	GIR	TP.A-041	19,5			
Transporter 1.7 Diesel T800	88-	GIR	TP.A-041	19,5			
Transporter 1.9 44/60 Van/Bus (T2)	86-	GIR	TP.A-041	19,5			
Transporter 1.9 57/78 Van/Bus (T2)	86-	GIR	TP.A-041	19,5			
Transporter 1.9 66/82 Van/Bus (T2)	86-	GIR	TP.A-041	19,5			
Transporter 1.9 T 800 (T 3)	88-90	GIR	TP.A-041	19,5			
Transporter 1.9 (CH) 54/73 Van/Bus (T2)	86-	GIR	TP.A-041	19,5			
Transporter 2.0 (T2) 51/70	86-	GIR	TP.A-041	19,5			
Transporter 2.0 (T3)	82-90	GIR	TP.A-041	19,5			
Transporter 2.1 (CH) 64/87 (T2)	86-	GIR	TP.A-041	19,5			
Transporter 2.1 (Dj/MV) (T3)	87-	GIR	TP.A-041	19,5			

Марка автомобиля	Годы выпуска автомобиля	Передние колодки			Задние колодки		
		Тип тормозной системы	№ по каталогу	Толщина изделия, мм	Тип тормозной системы	№ по каталогу	Толщина изделия, мм
VOLKSWAGEN							
Transporter T5 Bus (7HB, 7HJ) 1.9 TDI 16"	04/03-				ATE	TP.A-097	18,8
Transporter T5 Bus (7HB, 7HJ) 2.0	11/03-				ATE	TP.A-097	18,8
Transporter T5 Bus (7HB, 7HJ) 2,5 TDi	04/03-				ATE	TP.A-097	18,8
Transporter T5 Bus (7HB, 7HJ) 2,5 TDI 4 motion 16"	07/04				ATE	TP.A-097	18,8
Transporter T5 Flatbed/Chassis (7JD, 7JF, 7JL, 7JY, 7JZ) 1.9 TDI, 16", 17"	04/03-				ATE	TP.A-097	18,8
Transporter T5 Flatbed/Chassis (7JD, 7JF, 7JL, 7JY, 7JZ) 2.0, 16"	11/03-				ATE	TP.A-097	18,8
Transporter T5 Flatbed/Chassis (7JD, 7JF, 7JL, 7JY, 7JZ) 2.5 TDI 16"	04/03-				ATE	TP.A-097	18,8
Transporter T5 Flatbed/Chassis (7JD, 7JF, 7JL, 7JY, 7JZ) 2.5 TDI 4 motion 16", 17"	04/04-				ATE	TP.A-097	18,8
Transporter T5 Box (7HA, 7HH) 3.2 4 motion	11/03-				ATE	TP.A-097	18,8
Transporter T5 Box (7HA, 7HH) 3.2 v6 17"	04/03-				ATE	TP.A-097	18,8
Transporter T5 Bus (7HB, 7HJ) 1.9 TDI 17"	04/03-				ATE	TP.A-097	18,8
Transporter T5 Bus (7HB, 7HJ) 3.2 4motion, Ø308,0 mm	11/03-				ATE	TP.A-097	18,8
Transporter T5 Bus (7HB, 7HJ) 3.2 4motion, Ø333,0 mm	11/03-				ATE	TP.A-097	18,8
Transporter T5 Bus (7HB, 7HJ) 3.2 V6, 17"	02/04-				ATE	TP.A-097	18,8
Transporter T5 Flatbed/Chassis (7JD, 7JF, 7JL, 7JY, 7JZ) 3.2 4 motion V6 17"	08/03-				ATE	TP.A-097	18,8
Transporter T5 Box (7HA, 7HH) 1.9 TDI	04/03-	ATE	TP.A-097	19,8	TRW	TP.A-111	17,5
Transporter T5 Box (7HA, 7HH) 2.0, Ø294 mm, 314 mm	11/03-	ATE	TP.A-097	19,8	TRW	TP.A-111	17,5
Transporter T5 Box (7HA, 7HH) 2.5 TDI, Ø294 mm, 314 mm	11/03-	ATE	TP.A-097	19,8	TRW	TP.A-111	17,5
Transporter T5 Box (7HA, 7HH) 2.0 Bi TDI	09/09-	ATE	TP.A-097	19,8	TRW	TP.A-111	17,5
Transporter T5 Box (7HA, 7HH) 2.0 Bi TDI 4 motion	09/09-	ATE	TP.A-097	19,8	TRW	TP.A-111	17,5
Transporter T5 Box (7HA, 7HH) 2.0 TDL	09/09-	ATE	TP.A-097	19,8	TRW	TP.A-111	17,5
Transporter T5 Box (7HA, 7HH) 2.0 TDL 4 motion	09/09-	ATE	TP.A-097	19,8	TRW	TP.A-111	17,5
Transporter T5 Bus (7HB, 7HJ) (04/03-) 2.0 Bi TDL	09/09-	ATE	TP.A-097	19,8	TRW	TP.A-111	17,5
Transporter T5 Bus (7HB, 7HJ) 2.0 Bi TDL 4 motion	09/09-	ATE	TP.A-097	19,8	TRW	TP.A-111	17,5
Transporter T5 Bus (7HB, 7HJ) 2.0 TDL	09/09-	ATE	TP.A-097	19,8	TRW	TP.A-111	17,5
Transporter T5 Bus (7HB, 7HJ) 2.0 TDI 4 motion	09/09-	ATE	TP.A-097	19,8	TRW	TP.A-111	17,5

Марка автомобиля	Годы выпуска автомобиля	Передние колодки			Задние колодки		
		Тип тормозной системы	№ по каталогу	Толщина изделия, мм	Тип тормозной системы	№ по каталогу	Толщина изделия, мм
VOLKSWAGEN							
Transporter T5 Flatbed/Chassis (7JD, 7JF, 7JL, 7JY, 7JZ) 2.0 Bi TDL;	09/09-				TRW	TP.A-111	17,5
Transporter T5 Flatbed/Chassis (7JD, 7JF, 7JL, 7JY, 7JZ) 2.0 Bi TDL 4 motion	09/09-				TRW	TP.A-111	17,5
Transporter T5 Flatbed/Chassis (7JD, 7JF, 7JL, 7JY, 7JZ) 2.0 TDL	09/09-				TRW	TP.A-111	17,5
Transporter T5 Flatbed/Chassis (7JD, 7JF, 7JL, 7JY, 7JZ) 2.0 TDI 4 motion	09/09-				TRW	TP.A-111	17,5
Transporter T5 Box (7HA, 7HH) 2.5 TDI 4 motion Ø 294 mm, Ø314,0 mm	07/04-	ATE	TP.A-097	19,8	TRW	TP.A-111	17,5
Transporter T5 Box (7HA, 7HH) 3.2 4 motion Ø 294 mm, Ø314,0 mm	11/03-	ATE	TP.A-097	19,8	TRW	TP.A-111	17,5
Transporter T5 Box (7HA, 7HH) 3.2 V6	04/03-	ATE	TP.A-097	19,8	TRW	TP.A-111	17,5
Transporter T5 Bus (7HB, 7HJ) 1.9 TDI 16"	04/03-	ATE	TP.A-097	19,8	TRW	TP.A-111	17,5
Transporter T5 Bus (7HB, 7HJ) 2.0 16"	11/03-	ATE	TP.A-097	19,8	TRW	TP.A-111	17,5
Transporter T5 Bus (7HB, 7HJ) 2.5 TDi 16"					TRW	TP.A-111	17,5
Transporter T5 Bus (7HB, 7HJ) 2.5 TDi; 4 motion, 16"	07/04-	ATE	TP.A-097	19,8	TRW	TP.A-111	17,5
Transporter T5 Bus (7HB, 7HJ) 2.5 TDi 4 motion, 16"	07/04-	ATE	TP.A-097	19,8	TRW	TP.A-111	17,5
Transporter T5 Bus (7HB, 7HJ) 3.2 4 motion	11/03-	ATE	TP.A-097	19,8	TRW	TP.A-111	17,5
Transporter T5 Bus (7HB, 7HJ) 3.2 V6	02/04-	ATE	TP.A-097	19,8	TRW	TP.A-111	17,5
Transporter T5 Flatbed/Chassis (7JD, 7JF, 7JL, 7JY, 7JZ) 1.9 TDI	04/03-				TRW	TP.A-111	17,5
Transporter T5 Flatbed/Chassis (7JD, 7JF, 7JL, 7JY, 7JZ) 2.0	11/03-				TRW	TP.A-111	17,5
					TRW	TP.A-111	17,5
Transporter 2.5 TDI	04/03-				TRW	TP.A-111	17,5
Transporter 2.5 TDI 4 motion	04/04-				TRW	TP.A-111	17,5
Transporter 3.2 V6	04/04-				TRW	TP.A-111	17,5
Transporter 2.0 Bus (T4)	90-	GIR	TP.A-047	18,0			
Transporter 1.9 Diesel Bus (T4)	90-93	GIR	TP.A-047	18,0			
Transporter 1.9 TD Caravelle Bus (T4)	93-	GIR	TP.A-047	18,0			
Transporter 2.4 Diesel (T4) 15'' Wheel	90-	GIR	TP.A-047	18,0			
Transporter (Bus) (T4) 1.8, 15'' ventilated discs	90-93	GIR	TP.A-047	18,0			
unventilated discs		GIR	TP.A-048	18,0			
Transporter (Bus)(T4)2.0,2.0 Caravelle 15'' ventilated discs	90-	GIR	TP.A-047	18,0			
unventilated discs		GIR	TP.A-048	18,0			
Transporter (Bus) (T4) 2.5,2.5 Bus Caravelle 15'' ventilated discs	90-	GIR	TP.A-047	18,0			
unventilated discs		GIR	TP.A-048	18,0			

Марка автомобиля	Годы выпуска автомобиля	Передние колодки			Задние колодки		
		Тип тормозной системы	№ по каталогу	Толщина изделия, мм	Тип тормозной системы	№ по каталогу	Толщина изделия, мм
VOLKSWAGEN							
Transporter (Bus) (T4) 2.5 Syncro, Syncro Panel van, 15'' ventilated discs unventilated discs	92-	GIR GIR	TP.A-047 TP.A-048	18,0 18,0			
Transporter (Bus) (T4) 2.5 Syncro Caravelle 15'' ventilated discs unventilated discs	93-	GIR GIR	TP.A-047 TP.A-048	18,0 18,0			
Transporter (Bus) (T4) 2.8 Caravelle Bus 15'' ventilated discs unventilated discs	96-	GIR GIR	TP.A-047 TP.A-048	18,0 18,0			
Transporter (Bus) (T4) 1.9 Diesel, 15'' ventilated discs unventilated discs	90-	GIR GIR	TP.A-047 TP.A-048	18,0 18,0			
Transporter (Bus) (T4) 1.9 Diesel Caravelle 15'' ventilated discs unventilated discs	90-	GIR GIR	TP.A-047 TP.A-048	18,0 18,0			
Transporter (Bus) (T4) 1.9 TD, 15'' ventilated discs unventilated discs	92-	GIR GIR	TP.A-047 TP.A-048	18,0 18,0			
Transporter (Bus) (T4) 1.9 TD, Caravelle 15'' ventilated discs unventilated discs	93-	GIR GIR	TP.A-047 TP.A-048	18,0 18,0			
Transporter 2.4 Diesel, Diesel Bus, Diesel Panel van, Diesel Caravelle , 15'' ventilated discs unventilated discs	99-	GIR GIR	TP.A-047 TP.A-048	18,0 18,0			
Transporter (Bus) (T4) 2.4 Diesel Syncro, Syncro Panel van, 15'' ventilated discs unventilated discs	92-	GIR GIR	TP.A-047 TP.A-048	18,0 18,0			
Transporter (Bus) (T4) 2.5 TD, 15'' ventilated discs unventilated discs	95-	GIR GIR	TP.A-047 TP.A-048	18,0 18,0			
Transporter / Caravelle III Bus 1,6 TD (Syncro)	08/84 – 07/92	GIR	TP.A-041	19,5			
Transporter / Caravelle III Bus 1,7 D	10/86 – 07/92	GIR	TP.A-041	19,5			
Transporter / Caravelle III Bus 1,9 (Syncro)	08/82 – 07/92	GIR	TP.A-041	19,5			
Transporter / Caravelle III Bus 2,1i (KAT / Syncro)	08/85 – 07/92	GIR	TP.A-041	19,5			
Transporter / Caravelle V Bus 1,9 TDI	04/03 – 11/09	ATE	TP.A-097	19,8	TRW	TP.A-111	17,5
Transporter / Caravelle V Bus 2,0	11/03 –	ATE	TP.A-097	19,8	TRW	TP.A-111	17,5
Transporter / Caravelle V Bus 2,0 BiTDI (4 motion)	09/09 –	ATE	TP.A-097	19,8	TRW	TP.A-111	17,5
Transporter / Caravelle V Bus 2,0 TDI	09/09 –	ATE	TP.A-097	19,8	TRW	TP.A-111	17,5
Transporter / Caravelle V Bus 2,0 TDI 4 motion	09/09 –	ATE	TP.A-097	19,8	TRW	TP.A-111	17,5

Марка автомобиля	Годы выпуска автомобиля	Передние колодки			Задние колодки		
		Тип тормозной системы	№ по каталогу	Толщина изделия, мм	Тип тормозной системы	№ по каталогу	Толщина изделия, мм
VOLKSWAGEN							
Transporter T5 Box (7HA, 7HH) 1.9 TDI	04/03-				ATE	TP.A-097	18,8
Transporter T5 Box (7HA, 7HH) 2.0	11/03-				ATE	TP.A-097	18,8
Transporter T5 Box (7HA, 7HH) 2.5 TDI 16", 17"	04/03-				ATE	TP.A-097	18,8
Transporter T5 Box (7HA, 7HH) 2.5 TDI 4 motion, 16", 17"	07/04-				ATE	TP.A-097	18,8
Transporter T5 Bus (7HB, 7HJ) 1.9 TDI 16"	04/03-				ATE	TP.A-097	18,8
Transporter T5 Bus (7HB, 7HJ) 2.0	11/03-				ATE	TP.A-097	18,8
Transporter T5 Bus (7HB, 7HJ) 2,5 TDi	04/03-				ATE	TP.A-097	18,8
Transporter T5 Bus (7HB, 7HJ) 2,5 TDI 4 motion 16"	07/04				ATE	TP.A-097	18,8
Transporter T5 Flatbed/Chassis (7JD, 7JF, 7JL, 7JY, 7JZ) 1.9 TDI, 16", 17"	04/03-				ATE	TP.A-097	18,8
Transporter T5 Flatbed/Chassis (7JD, 7JF, 7JL, 7JY, 7JZ) 2.0, 16"	11/03-				ATE	TP.A-097	18,8
Transporter T5 Flatbed/Chassis (7JD, 7JF, 7JL, 7JY, 7JZ) 2.5 TDI 16"	04/03-				ATE	TP.A-097	18,8
Transporter T5 Flatbed/Chassis (7JD, 7JF, 7JL, 7JY, 7JZ) 2.5 TDI 4 motion 16", 17"	04/04-				ATE	TP.A-097	18,8
Transporter T5 Box (7HA, 7HH) 3.2 4 motion	11/03-				ATE	TP.A-097	18,8
Transporter T5 Box (7HA, 7HH) 3.2 v6 17"	04/03-				ATE	TP.A-097	18,8
Transporter T5 Bus (7HB, 7HJ) 1.9 TDI 17"	04/03-				ATE	TP.A-097	18,8
Transporter T5 Bus (7HB, 7HJ) 3.2 4motion, Ø308,0 mm	11/03-				ATE	TP.A-097	18,8
Transporter T5 Bus (7HB, 7HJ) 3.2 4motion, Ø333,0 mm	11/03-				ATE	TP.A-097	18,8
Transporter T5 Bus (7HB, 7HJ) 3.2 V6, 17"	02/04-				ATE	TP.A-097	18,8
Transporter T5 Flatbed/Chassis (7JD, 7JF, 7JL, 7JY, 7JZ) 3.2 4 motion V6 17"	08/03-				ATE	TP.A-097	18,8
Transporter T5 Box (7HA, 7HH) 2.5 TDI 4 motion Ø 294 mm, Ø314,0 mm	07/04-				TRW	TP.A-111	17,5
Transporter T5 Box (7HA, 7HH) 3.2 4 motion Ø 294 mm, Ø314,0 mm	11/03-				TRW	TP.A-111	17,5
Transporter T5 Box (7HA, 7HH) 3.2 V6	04/03-				TRW	TP.A-111	17,5
Transporter T5 Bus (7HB, 7HJ) 1.9 TDI 16"	04/03-				TRW	TP.A-111	17,5
Transporter T5 Bus (7HB, 7HJ) 2.0 16"	11/03-				TRW	TP.A-111	17,5
Transporter T5 Bus (7HB, 7HJ) 2.5 TDi 16"					TRW	TP.A-111	17,5
Transporter T5 Bus (7HB, 7HJ) 2.5 TDi; 4 motion, 16"	07/04-				TRW	TP.A-111	17,5

Марка автомобиля	Годы выпуска автомобиля	Передние колодки			Задние колодки		
		Тип тормозной системы	№ по каталогу	Толщина изделия, мм	Тип тормозной системы	№ по каталогу	Толщина изделия, мм
VOLKSWAGEN							
Transporter T5 Bus (7HB, 7HJ) 2.5 TDi 4 motion, 16''	07/04-				TRW	TP.A-111	17,5
Transporter T5 Bus (7HB, 7HJ) 3.2 4 motion	11/03-				TRW	TP.A-111	17,5
Transporter T5 Bus (7HB, 7HJ) 3.2 V6	02/04-				TRW	TP.A-111	17,5
Transporter T5 Flatbed/Chassis (7JD, 7JF, 7JL, 7JY, 7JZ) 1.9 TDI	04/03-				TRW	TP.A-111	17,5
Transporter T5 Flatbed/Chassis (7JD, 7JF, 7JL, 7JY, 7JZ) 2.0	11/03-				TRW	TP.A-111	17,5
					TRW	TP.A-111	17,5
Transporter 2.5 TDI	04/03-				TRW	TP.A-111	17,5
Transporter 2.5 TDI 4 motion	04/04-				TRW	TP.A-111	17,5
Transporter 3.2 V6	04/04-				TRW	TP.A-111	17,5
Transporter 2.0 Bus (T4)	90-	GIR	TP.A-047	18,0			
Transporter 1.9 Diesel Bus (T4)	90-93	GIR	TP.A-047	18,0			
Transporter 1.9 TD Caravelle Bus (T4)	93-	GIR	TP.A-047	18,0			
Transporter 2.4 Diesel (T4) 15'' Whell	90-	GIR	TP.A-047	18,0			
Transporter (Bus) (T4) 1.8, 15'' ventilated discs	90-93	GIR	TP.A-047	18,0			
unventilated discs		GIR	TP.A-048	18,0			
Transporter (Bus)(T4)2.0,2.0 Caravelle 15'' ventilated discs	90-	GIR	TP.A-047	18,0			
unventilated discs		GIR	TP.A-048	18,0			
Transporter (Bus) (T4) 2.5,2.5 Bus Caravelle 15'' ventilated discs	90-	GIR	TP.A-047	18,0			
unventilated discs		GIR	TP.A-048	18,0			
Transporter (Bus) (T4) 2.5 Syncro, Syncro Panel van, 15'' ventilated discs	92-	GIR	TP.A-047	18,0			
unventilated discs		GIR	TP.A-048	18,0			
Transporter (Bus) (T4) 2.5 Syncro Caravelle 15'' ventilated discs	93-	GIR	TP.A-047	18,0			
unventilated discs		GIR	TP.A-048	18,0			
Transporter (Bus) (T4) 2.8 Caravelle Bus 15'' ventilated discs	96-	GIR	TP.A-047	18,0			
unventilated discs		GIR	TP.A-048	18,0			
Transporter (Bus) (T4) 1.9 Diesel, 15'' ventilated discs	90-	GIR	TP.A-047	18,0			
unventilated discs		GIR	TP.A-048	18,0			
Transporter (Bus) (T4) 1.9 Diesel Caravelle 15'' ventilated discs	90-	GIR	TP.A-047	18,0			
unventilated discs		GIR	TP.A-048	18,0			
Transporter (Bus) (T4) 1.9 TD, 15'' ventilated discs	92-	GIR	TP.A-047	18,0			
unventilated discs		GIR	TP.A-048	18,0			

Марка автомобиля	Годы выпуска автомобиля	Передние колодки			Задние колодки		
		Тип тормозной системы	№ по каталогу	Толщина изделия, мм	Тип тормозной системы	№ по каталогу	Толщина изделия, мм
VOLKSWAGEN							
Transporter (Bus) (T4) 1.9 TD, Caravelle 15'' ventilated discs unventilated discs	93-	GIR GIR	TP.A-047 TP.A-048	18,0 18,0			
Transporter 2.4 Diesel, Diesel Bus, Diesel Panel van, Diesel Caravelle , 15'' ventilated discs unventilated discs	99-	GIR GIR	TP.A-047 TP.A-048	18,0 18,0			
Transporter (Bus) (T4) 2.4 Diesel Syncro, Syncro Panel van, 15'' ventilated discs unventilated discs	92-	GIR GIR	TP.A-047 TP.A-048	18,0 18,0			
Transporter (Bus) (T4) 2.5 TD, 15'' ventilated discs unventilated discs	95-	GIR GIR	TP.A-047 TP.A-048	18,0 18,0			
Transporter / Caravelle III Bus 1,6 TD (Syncro)	08/84 – 07/92	GIR	TP.A-041	19,5			
Transporter / Caravelle III Bus 1,7 D	10/86 – 07/92	GIR	TP.A-041	19,5			
Transporter / Caravelle III Bus 1,9 (Syncro)	08/82 – 07/92	GIR	TP.A-041	19,5			
Transporter / Caravelle III Bus 2,1i (KAT / Syncro)	08/85 – 07/92	GIR	TP.A-041	19,5			
Transporter / Caravelle V Bus 1,9 TDI	04/03 – 11/09	ATE	TP.A-097	19,8	TRW	TP.A-111	17,5
Transporter / Caravelle V Bus 2,0	11/03 –	ATE	TP.A-097	19,8	TRW	TP.A-111	17,5
Transporter / Caravelle V Bus 2,0 BiTDI (4 motion)	09/09 –	ATE	TP.A-097	19,8	TRW	TP.A-111	17,5
Transporter / Caravelle V Bus 2,0 TDI	09/09 –	ATE	TP.A-097	19,8	TRW	TP.A-111	17,5
Transporter / Caravelle V Bus 2,0 TDI 4 motion	09/09 –	ATE	TP.A-097	19,8	TRW	TP.A-111	17,5
Transporter / Caravelle V Bus 2,0 TSI	05/11 –	ATE	TP.A-097	19,8	TRW	TP.A-111	17,5
Transporter / Caravelle V Bus 2,0 TSI 4 motion	07/11 –	ATE	TP.A-097	19,8	TRW	TP.A-111	17,5
Transporter / Caravelle V Bus 2,5 TDI	04/03 - 11/09	ATE	TP.A-097	19,8	TRW	TP.A-111	17,5
Transporter / Caravelle V Bus 2,5 TDI 4 motion	07/04 – 11/09	ATE	TP.A-097	19,8	TRW	TP.A-111	17,5
Transporter / Caravelle V Bus 3,2 V6	02/04 – 11/09	ATE	TP.A-097	19,8	TRW	TP.A-111	17,5
Transporter / Caravelle V Bus 3,2 V6 4 motion	11/03 – 11/09	ATE	TP.A-097	19,8	TRW	TP.A-111	17,5
Transporter / Multivan IV Bus 1,8	12/90 – 07/92	GIR	TP.A-047 TP.A-048	18,0			
Transporter / Multivan IV Bus 1,9 D / TD	09/90 – 04/03	GIR	TP.A-047 TP.A-048	18,0			
Transporter / Multivan IV Bus 2,0	09/90 – 04/03	GIR	TP.A-047 TP.A-048	18,0			
Transporter / Multivan IV Bus 2,4 D (Syncro)	09/90- 04/03	GIR	TP.A-047 TP.A-048	18,0			

Марка автомобиля	Годы выпуска автомобиля	Передние колодки			Задние колодки		
		Тип тормозной системы	№ по каталогу	Толщина изделия, мм	Тип тормозной системы	№ по каталогу	Толщина изделия, мм
VOLKSWAGEN							
Transporter / Multivan IV Bus 2,5 (Syncro)	11/90 – 04/03	GIR	TP.A-047 TP.A-048	18,0			
Transporter / Multivan IV Bus 2,5 TDI (Syncro)	09/95 – 04/03	GIR	TP.A-047 TP.A-048	18,0			
Transporter / Multivan IV Bus 2,8 VR6	11/95 – 04/03	GIR	TP.A-047 TP.A-048	18,0			
Transporter T3 Box 1,6 TD (Syncro)	10/84 – 07/92	GIR	TP.A-041	19,5			
Transporter T3 Box 1,7 D	08/85 – 07/92	GIR	TP.A-041	19,5			
Transporter T3 Box 1,9 (Syncro)	10/82 – 07/92	GIR	TP.A-041	19,5			
Transporter T3 Box 2,1i (Syncro)	08/85 – 07/92	GIR	TP.A-041	19,5			
Transporter T3 Bus 1,6 TD (Syncro)	08/84 – 07/92	GIR	TP.A-041	19,5			
Transporter T3 Bus 1,7 D	10/86 – 07/92	GIR	TP.A-041	19,5			
Transporter T3 Bus 1,9 (Syncro)	08/82 – 07/92	GIR	TP.A-041	19,5			
Transporter T3 Bus 2,1i (KAT / Syncro)	08/85 – 07/92	GIR	TP.A-041	19,5			
Transporter T4 Box (70XA) 1,9 D / TD	07/90 – 04/03	GIR	TP.A-047 TP.A-048	18,0			
Transporter T4 Box (70XA) 2,0	07/90 – 04/03	GIR	TP.A-047 TP.A-048	18,0			
Transporter T4 Box (70XA) 2,4 D (Syncro)	07/90 – 04/03	GIR	TP.A-047 TP.A-048	18,0			
Transporter T4 Box (70XA) 2,5 (Syncro)	11/90 – 04/03	GIR	TP.A-047 TP.A-048	18,0			
Transporter T4 Box (70XA) 2,5 TDI (Syncro)	09/95 – 04/03	GIR	TP.A-047 TP.A-048	18,0			
Transporter T4 Box (70XA) 2,8 VR6	05/96 – 04/03	GIR	TP.A-047 TP.A-048	18,0			
Transporter T5 Box 2,0 TSI	05/11 –	ATE	TP.A-097	19,8	TRW	TP.A-111	17,5
Transporter T5 Box 2,0 TSI 4 motion	07/11 –	ATE	TP.A-097	19,8	TRW	TP.A-111	17,5
Transporter T5 Bus 2,0 TSI	05/11 –	ATE	TP.A-097	19,8	TRW	TP.A-111	17,5
Transporter T5 Bus 2,0 TSI 4 motion	07/11 –	ATE	TP.A-097	19,8	TRW	TP.A-111	17,5
UP 1,0	12/11 –	ATE	TP.A-065	19,8			
UP 1,0 EcoFuel	11/12 –	ATE	TP.A-065	19,8			
Vento 1,6i CL, GL	92-	ATE	TPA-024025	19,7			
Vento 1,6i CL, GL (ABS)	92-	GIR	TP.A-003	16,5	GIR	TP.A-014	15,0
Vento 1,8i CL, GL, GT	92-	ATE	TPA-024025	19,7			
Vento 1,4 CL, GL	91-	ATE	TPA-024025	19,7			
Vento 1,4 CL, GL	92-	GIR	TP.A-003	16,5			
Vento 1,4 CL, GL	92-	ATE	TPA-024025	19,7			
Vento 1,8i CL, GL, GT (ABS)	92-	GIR	TP.A-003	16,5	GIR	TP.A-014	15,0

Марка автомобиля	Годы выпуска автомобиля	Передние колодки			Задние колодки		
		Тип тормозной системы	№ по каталогу	Толщина изделия, мм	Тип тормозной системы	№ по каталогу	Толщина изделия, мм
VOLKSWAGEN							
Vento 2,0i 16V GT, CL, GL	92-	GIR	TP.A-003	16,5	GIR	TP.A-014	15,0
Vento 2,8i GL VR6, GLX VR6, VR6 (ABS)	92-	GIR	TP.A-003	16,5	GIR	TP.A-014	15,0
Vento 2,8 VR6	91-				GIR	TP.A-014	17,4
Vento 1,9 D CL, GL, GTD	92-	ATE	TPA-024025	19,7			
Vento 1,9 D CL, GL, GTD (ABS)	92-	GIR	TP.A-003	16,5	GIR	TP.A-014	15,0
Vento 1,9 D CL, GL, GTD (ABS)	92-	GIR	TP.A-003	16,5			
Vento 1,9 D CL, GL, GT, GTD	92-	ATE	TPA-024025	19,7			
Vento 1,9 D CL, GL, GT, GTD (ABS)	92-	GIR	TP.A-003	16,5	GIR	TP.A-014	15,0
Vento 1,9 D CL, GL, GT, GTD (ABS)	92-	GIR	TP.A-003	16,5			
Vento (1H2) 1.6 Ø 239,0 mm, Ø 256,0 mm	09/92-09/98	TRW	TP.A-073	16,0/19,5	GIR	TP.A-014	15,0
Vento (1H2) 1.8 Ø 239,0 mm, Ø 256,0 mm	11/91-09/98	TRW	TP.A-073	16,0/19,5	GIR	TP.A-014	15,0
Vento (1H2) 1.9 TDi	09/93-09/98	TRW	TP.A-073	16,0/19,5	GIR	TP.A-014	15,0
Vento (1H2) 2.0, 2.0 GL	11/91-09/98	TRW	TP.A-073	16,0/19,5	GIR	TP.A-014	15,0
Vento III (1K2) 1,4 TSI	07/08 – 10/10	ATE	TP.A-093	19,8			
Vento III (1K2) 1,6	10/05 – 10/10	ATE	TP.A-093	19,8			
Vento III (1K2) 1,6 FSI	09/05 – 10/10	ATE	TP.A-093	19,8			
Vento III (1K2) 1,6 TDI	06/09 – 10/10	ATE	TP.A-093	19,8			
Vento III (1K2) 1,9 TDI	08/05 – 10/10	ATE	TP.A-093	19,8			
Vento IV (162) 1,2 TSI	02/11 –	ATE	TP.A-093	19,8			
Vento IV (162) 1,4 TSI (Hybrid)	04/11 –	ATE	TP.A-065 TP.A-092 TP.A-093	19,8			
Vento IV (162) 1,6	12/11 –	ATE	TP.A-093	19,8			
Vento IV (162) 1,6 TDI	02/11 –	ATE	TP.A-093	19,8			
Vento IV (162) 2,0 TSI / TDI	10/10 –	ATE	TP.A-065 TP.A-092 TP.A-093	19,8			
Vento V Estate (1K5) 1,4	06/07 –	ATE	TP.A-093	19,8			
Vento V Estate (1K5) 1,4 TSI	06/07 –	ATE	TP.A-093	19,8			
Vento V Estate (1K5) 1,6	06/07 –	ATE	TP.A-093	19,8			
Vento V Estate (1K5) 1,9 TDI (4 motion)	06/07 –	ATE	TP.A-093	19,8			
Vento V Estate (1K5) 2,0	06/07 –	ATE	TP.A-093	19,8			
Vento V Estate (1K5) 2,0 TDI (16V)	06/07 –	ATE	TP.A-093	19,8			
Vento Sedan (1H2) 1,4	11/91 – 09/98	VAG	TPA-024/025	19,7			
Vento Sedan (1H2) 1,6	09/92 – 09/98	VAG ATE	TPA-024/025 TP.A-073	15,3 16,0/19,5	GIR	TP.A-014	15,0

Марка автомобиля	Годы выпуска автомобиля	Передние колодки			Задние колодки		
		Тип тормозной системы	№ по каталогу	Толщина изделия, мм	Тип тормозной системы	№ по каталогу	Толщина изделия, мм
VOLVO							
Vento Sedan (1H2) 1,8	11/91 – 09/98	VAG ATE	TP.A-024/025 TP.A-073	15,3 16,0/19,5	GIR	TP.A-014	15,0
Vento Sedan (1H2) 1,9 TD / TDI	11/91 – 09/98	VAG ATE	TP.A-024/025 TP.A-073	15,3 16,0/19,5	GIR	TP.A-014	15,0
Vento Sedan (1H2) 2,0	11/91 – 09/98	GIR ATE	TP.A-003 TP.A-073	16,5 16,0/19,5	GIR	TP.A-014	15,0
Vento Sedan (1H2) 2,8 VR6	01/92 – 09/98	ATE	TP.A-073	16,0/19,5	GIR	TP.A-014	15,0
Vento Sedan (60) 1,6	05/10 –	ATE	TP.A-065 TP.A-092 TP.A-093	19,8			
142 2,0i GL.S	70-74	GIR	TP.A-023	16,0	ATE	TP.A-001	15,0
144 2,0i GL.S	70-74	GIR	TP.A-023	16,0	ATE	TP.A-001	15,0
145 2,0i GL.S	70-74	GIR	TP.A-023	16,0	ATE	TP.A-001	15,0
164 1,6 P (1600)	70-75	GIR	TP.A-023	16,0	ATE	TP.A-001	15,0
164 2,9E Sedan	08/68-07/73	GIR	TP.A-023	16,0	ATE	TP.A-001	15,0
220 2,0 S All Models	68-72				ATE	TP.A-001	15,0
221 2,0 All Models	68-72				ATE	TP.A-001	15,0
240 2,0 All Models	71-	GIR	TP.A-023	16,0	ATE	TP.A-001	15,0
240 2,0 DL, GL	84-85				ATE	TP.A-001	15,0
240 2,0 DL, GL (ABS)	85-	GIR	TP.A-023	16,0	ATE	TP.A-001	15,0
240 2,0i	84-85				ATE	TP.A-001	15,0
240 2,0i (ABS)	85-				ATE	TP.A-001	15,0
240 2,0i GLE, Polar (ABS)	84-85				ATE	TP.A-001	15,0
240 2,0i Polar	85-				ATE	TP.A-001	15,0
240 2,1 All Models	74-84	GIR	TP.A-023	16,0	ATE	TP.A-001	15,0
240 2,1 SLE	74-82				ATE	TP.A-001	15,0
240 2,1 Turbo	80-	GIR	TP.A-023	16,0	ATE	TP.A-001	15,0
240 2,3 All Models	82-	GIR	TP.A-023	16,0	ATE	TP.A-001	15,0
240 2,3 DL, GL Grand Luxe (ABS)	85-86				ATE	TP.A-001	15,0
240 2,3 DL, GL Grand Luxe, GLE GLT (ABS)	84-86				ATE	TP.A-001	15,0
240 2,3 GLT	74-86				ATE	TP.A-001	15,0
240 2,3i All Models	86-	GIR	TP.A-023	16,0	ATE	TP.A-001	15,0
240 2,3i DL, GL, GLE, GLT, Gli (ABS)	84-				ATE	TP.A-001	15,0
240 2,3i GL Polar (ABS)	85-				ATE	TP.A-001	15,0
240 2,3i GLE, Polar, GLT	84-				ATE	TP.A-001	15,0
240 2,4 D All Models	74-82	GIR	TP.A-023	16,0	ATE	TP.A-001	15,0
240 2,4 D DL, GL, GLD	74-82	GIR	TP.A-023	16,0	ATE	TP.A-001	15,0
240 2,4 D DL, GLD	82-	GIR	TP.A-023	16,0	ATE	TP.A-001	15,0
240 2,4 D DL, GLD (ABS)	85-	GIR	TP.A-023	16,0	ATE	TP.A-001	15,0
240 2,4 D GLD, Overdrive	84-85	GIR	TP.A-023	16,0	ATE	TP.A-001	15,0

Марка автомобиля	Годы выпуска автомобиля	Передние колодки			Задние колодки		
		Тип тормозной системы	№ по каталогу	Толщина изделия, мм	Тип тормозной системы	№ по каталогу	Толщина изделия, мм
VOLVO							
240 2,3i Van DL, GL, GLE, GLT, GLi (ABS)	85-				ATE	TP.A-001	15,0
240 2,3i Van GLE, Polar, GLT (ABS)	92				ATE	TP.A-001	15,0
240 2,3 Van DL, Van GL, Grand Luxe (ABS)	85-86				ATE	TP.A-001	15,0
240 2,4 D Van DL, GLD (ABS)	85-				ATE	TP.A-001	15,0
240 2,4 D Van GL Grand Luxe (ABS)	85-				ATE	TP.A-001	15,0
242 1,7 All Models	78-84				ATE	TP.A-001	15,0
242 2,0 FDL, L, GL	78-84	GIR	TP.A-023	16,0	ATE	TP.A-001	15,0
242 2,1 DL, FGT, GL	79-84	GIR	TP.A-023	16,0	ATE	TP.A-001	15,0
242 2,1i DL, FGT, GL, Turbo	79-84	GIR	TP.A-023	16,0	ATE	TP.A-001	15,0
242 2,2i GLE, GLi	79-84				ATE	TP.A-001	15,0
242 2,3i GL, GLE, GLi	79-84	GIR	TP.A-023	16,0	ATE	TP.A-001	15,0
244 1,7 All Models	78-84				ATE	TP.A-001	15,0
244 2,1 DL, FGT, GL	79-84	GIR	TP.A-023	16,0	ATE	TP.A-001	15,0
244 2,1i DL, FGT, GL, Turbo	79-84	GIR	TP.A-023	16,0	ATE	TP.A-001	15,0
244 2,2i GLE, GLi	79-84	GIR	TP.A-023	16,0	ATE	TP.A-001	15,0
244 2,3i GL, GLE, GLi	79-84	GIR	TP.A-023	16,0	ATE	TP.A-001	15,0
244 2,0 D DL	78-84	GIR	TP.A-023	16,0	ATE	TP.A-001	15,0
244 2,0 FDL, L, GL	78-84	GIR	TP.A-023	16,0	ATE	TP.A-001	15,0
244 2,4 D DL6, GL, Overdrive	78-84	GIR	TP.A-023	16,0	ATE	TP.A-001	15,0
245 1,7 All Models	78-84				ATE	TP.A-001	15,0
245 2,0 D, DL	78-84	GIR	TP.A-023	16,0	ATE	TP.A-001	15,0
245 2,0 FDL, L, GL	78-84	GIR	TP.A-023	16,0	ATE	TP.A-001	15,0
245 2,1 DL, FGT, GL	78-84	GIR	TP.A-023	16,0	ATE	TP.A-001	15,0
245 2,4 D DL6, GL, Overdrive	78-84	GIR	TP.A-023	16,0	ATE	TP.A-001	15,0
260 2,6 All Models	74-82				ATE	TP.A-001	15,0
260 2,8 All Models	74-82	GIR	TP.A-023	16,0	ATE	TP.A-001	15,0
262 2,7 GL	78-79	GIR	TP.A-023	16,0	ATE	TP.A-001	15,0
262 2,7i Turbo C, GLE	78-79	GIR	TP.A-023	16,0	ATE	TP.A-001	15,0
262 2,8i GLE	80-81	GIR	TP.A-023	16,0	ATE	TP.A-001	15,0
264 2,7 GL Overdrive	78-79	GIR	TP.A-023	16,0	ATE	TP.A-001	15,0
264 2,7i DL, GL, GLE	78-79	GIR	TP.A-023	16,0	ATE	TP.A-001	15,0
264 2,8i GLE, DL, GL, Overdrive	80-81	GIR	TP.A-023	16,0	ATE	TP.A-001	15,0
264 2,4 D DL6	78-79	GIR	TP.A-023	16,0	ATE	TP.A-001	15,0
265 2,7 GL, Overdrive	78-79	GIR	TP.A-023	16,0	ATE	TP.A-001	15,0
265 2,7i DL, GL, GLE	78-79	GIR	TP.A-023	16,0	ATE	TP.A-001	15,0
265 2,8i GLE, DL, GL, Overdrive	80-81				ATE	TP.A-001	15,0
265 2,4 D DL6	78-79				ATE	TP.A-001	15,0
440 (k/kx) all models	88-	GIR	TP.A-037	17,5	ATE	TP.A-008	15,0
460 (l-lx) all models	89-	GIR	TP.A-037	17,5	ATE	TP.A-008	15,0
480 (e/ex) all models	86-	GIR	TP.A-037	17,5	ATE	TP.A-008	15,0
740 2,0 GLE	89-	BEN	TP.A-032	16,4			
740 2,0	89-	BEN	TP.A-032	16,4			

Марка автомобиля	Годы выпуска автомобиля	Передние колодки			Задние колодки		
		Тип тормозной системы	№ по каталогу	Толщина изделия, мм	Тип тормозной системы	№ по каталогу	Толщина изделия, мм
VOLVO							
740 2,0 All Models, ex. 2.0 Turbo (ABS)	87-90	BEN	TP.A-032	16,4	ATE	TP.A-001	15,0
740 2,0i 16V GLE (ABS)	87-90				ATE	TP.A-001	15,0
740 2,0i GLE (ABS)	87-92				ATE	TP.A-001	15,0
740 2,0i Turbo Overdrive	84-				ATE	TP.A-001	15,0
740 2.0	90-91	BEN	TP.A-032	16,4			
740 2,3 GL	89-	BEN	TP.A-032	16,4	ATE	TP.A-001	15,0
740 2,3i 16V GLE, GLT, GL, Overdrive (ABS)	87-90				ATE	TP.A-001	15,0
740 2,3i Grand Luxe	87-90				ATE	TP.A-001	15,0
740 2,3i GL, GLE (ABS)	92-				ATE	TP.A-001	15,0
740 2,3i Turbo, Turbo Interc. (ABS)	87-90				ATE	TP.A-001	15,0
740 2.3 GLT 16V Kombi	88-	BEN	TP.A-032	16,4			
740 Diesel 2,4	84-				ATE	TP.A-001	15,0
740 Diesel 2,4 16V Turbo	84-				ATE	TP.A-001	15,0
740 Diesel 2,4 D All Models (ABS)	87-90				ATE	TP.A-001	15,0
740 Diesel 2,4 Turbo	84-				ATE	TP.A-001	15,0
740 Diesel 2,4 D Turbo GLE, GL, Interc,	86-90	BEN	TP.A-032	16,4	ATE	TP.A-001	15,0
740 Diesel 2,4 Turbo	84-				ATE	TP.A-001	15,0
740 Diesel 2,4 D Combi	84-				ATE	TP.A-001	15,0
740 2,3 Turbo Kombi	89-	BEN	TP.A-032	16,4			
760 2,3i Turbo, GLE (ABS)	83-84				ATE	TP.A-001	15,0
760 2,3 Turbo	82-88				ATE	TP.A-001	15,0
760 2,0i Turbo	84-89	BEN	TP.A-032	16,4			
760 2,3 Turbo Cat	84-89	BEN	TP.A-032	16,4			
760 2,8i GLE, Executive (ABS)	82-90	BEN	TP.A-032	16,4	ATE	TP.A-001	15,0
760 2,4 D	82-88				ATE	TP.A-001	15,0
760 2,4 D Turbo GLE, Interc (ABC)	82-90	BEN	TP.A-032	16,4	ATE	TP.A-001	15,0
760 2,8 Combi	82-88				ATE	TP.A-001	15,0
780 2,8 All Models	86-90	BEN	TP.A-032	16,4	ATE	TP.A-001	15,0
850 2,0i 16V GLE, GLT, E (ABS)	93-				ATE	TP.A-001	15,0
850 2,0i 20V GLE, SE (ABS)	93-				ATE	TP.A-001	15,0
850 2,3i 20V T5 (ABS)	94-				ATE	TP.A-001	15,0
850 2,4i 2-V GLE, SE (ABS)	94-				ATE	TP.A-001	15,0
850 2,4i 30V GLT	94-				ATE	TP.A-001	15,0
850 2,5i 20V GLE (ABS)	93-				ATE	TP.A-001	15,0
850 2,5i 20V GLT (ABS)	93-				ATE	TP.A-001	15,0
850 2,5i All Models (ABS)	94-				ATE	TP.A-001	15,0
870 2.0 Turbo	89-90	BEN	TP.A-032	16,4			
940 2.0 GL	91-	BEN	TP.A-032	16,4			
940 2,0i 16V GLE	92-				ATE	TP.A-001	15,0
940 2,0i 16V GLE (ABS)	92-				ATE	TP.A-001	15,0
940 2,0i GL, GLE, Turbo	92-				ATE	TP.A-001	15,0
940 2,0i GL, GLE, Turbo (ABS)	92-				ATE	TP.A-001	15,0
940 2,0i Turbo SE	92-				ATE	TP.A-001	15,0
940 2,0i Turbo SE (ABS)	92-				ATE	TP.A-001	15,0

Марка автомобиля	Годы выпуска автомобиля	Передние колодки			Задние колодки		
		Тип тормозной системы	№ по каталогу	Толщина изделия, мм	Тип тормозной системы	№ по каталогу	Толщина изделия, мм
VOLVO							
940 2,3 All Models	90-93	BEN	TP.A-032	16,4			
940 2,3 All Models (ABS)	93-97				ATE	TP.A-001	15,0
940 2,4 D Turbo, GL, GLE, Interc.	92-				ATE	TP.A-001	15,0
940 2,4 D Turbo, GL, GLE, Interc. (ABS)	92-				ATE	TP.A-001	15,0
960 2,0i All Models	92-93	BEN	TP.A-032	16,4	ATE	TP.A-001	15,0
960 2,3i All Models	92-93				ATE	TP.A-001	15,0
960 2,0i All Models (ABS)	92-93				ATE	TP.A-001	15,0
960 2,5i All Models (ABS)	93-96				ATE	TP.A-001	15,0
960 2,8i All Models	92-93				ATE	TP.A-001	15,0
960 2,9i All Models	92-93	BEN	TP.A-032	16,4	ATE	TP.A-001	15,0
960 2,9i All Models (ABS)	90-				ATE	TP.A-001	15,0
960 2,4 D All Models	92-93				ATE	TP.A-001	15,0
960 2,4 Diesel, Turbo Diesel	90-97	BEN	TP.A-032	16,4			
960 2,4 Turbo Diesel Inter cooler	91-97	BEN	TP.A-032	16,4			
S 60 II 2,0 T	04/10 –	ATE	TP.A-079 TP.A-091	17,5 18,2			
S 60 II D3	04/10 –	ATE	TP.A-079 TP.A-091	17,5 18,2			
S 60 II D4	05/12 –	ATE	TP.A-079 TP.A-091	17,5 18,2			
S 60 II D5	04/10 –	ATE	TP.A-079 TP.A-091	17,5 18,2			
S 60 II D5 AWD	04/10 –	ATE	TP.A-079 TP.A-091	17,5 18,2			
S 60 II DRIVe / D2	01/11 –	ATE	TP.A-079 TP.A-091	17,5 18,2			
S 60 II T3 (T4)	04/10 –	ATE	TP.A-079 TP.A-091	17,5 18,2			
S 60 II T4F	04/11 –	ATE	TP.A-079 TP.A-091	17,5 18,2			
S 60 II T5	04/10 –	ATE	TP.A-079 TP.A-091	17,5 18,2			
S 60 II T6 AWD	04/10 –	ATE	TP.A-079 TP.A-091	17,5 18,2			
S 70 2,0 All Models	96-				ATE	TP.A-001	15,0
S 70 2,3 All Models	96-				ATE	TP.A-001	15,0
S 70 2,4 All Models	96-				ATE	TP.A-001	15,0
S 70 2,4 D All Models	96-				ATE	TP.A-001	15,0
S 70 2,0 All Models (ABS)	96-				ATE	TP.A-001	15,0
S 70 2,3 All Models (ABS)	96-				ATE	TP.A-001	15,0
S 70 2,4 All Models (ABS)	96-				ATE	TP.A-001	15,0
S 70 2,5 All Models (ABS)	96-				ATE	TP.A-001	15,0
S 80 II 2,4 D 16" Ch→53945	03/06-	ATE	TP.A-079				
S 80 II 2,4 D5 16", Ch→53945	03/06-	ATE	TP.A-079				
S 80 II 2,4 D5 AWD 16" Ch→539454	01/07-	ATE	TP.A-079				
S 80 II 2.5 T	03/06-	ATE	TP.A-079				
S 80 II 2.5 T AWD	10/06-	ATE	TP.A-079				

Марка автомобиля	Годы выпуска автомобиля	Передние колодки			Задние колодки		
		Тип тормозной системы	№ по каталогу	Толщина изделия, мм	Тип тормозной системы	№ по каталогу	Толщина изделия, мм
VOLVO							
S 80 II 2.5 T Flex Fuel, 16"	05/08-	ATE	TP.A-079				
S 80 II 3.2 16"	03/06-	ATE	TP.A-079				
S 80 II 3.2 AWD 16"	01/07-	ATE	TP.A-079				
S 80 II 4.4 V8 AWD, 16"	03/06-	ATE	TP.A-079				
S 80 II (AS) 1,6 D DRIVE	01/10 –	ATE	TP.A-079 TP.A-091	17,5 18,2			
S 80 II (AS) 2,0	01/08 –	ATE	TP.A-079 TP.A-091	17,5 18,2			
S 80 II (AS) 2,0 Flex Fuel	01/08 –	ATE	TP.A-079 TP.A-091	17,5 18,2			
S 80 II (AS) 2,0 TDi (T)	02/08 –	ATE	TP.A-079 TP.A-091	17,5 18,2			
S 80 II (AS) D3	01/10 –	ATE	TP.A-079 TP.A-091	17,5 18,2			
S 80 II (AS) D5	03/06 –	ATE	TP.A-079 TP.A-091	17,5 18,2			
S 80 II (AS) D5 AWD	01/10 –	ATE	TP.A-079 TP.A-091	17,5 18,2			
S 80 II (AS) T4	10/10 –	ATE	TP.A-079 TP.A-091	17,5 18,2			
S 80 II (AS) T4F	05/11 –	ATE	TP.A-079 TP.A-091	17,5 18,2			
S 80 II (AS) T5	10/10 –	ATE	TP.A-079 TP.A-091	17,5 18,2			
S 80 II (AS) T6 AWD	01/07 –	ATE	TP.A-079 TP.A-091	17,5 18,2			
S 80 II Sedan (AS) 1,6 D DRIVE	01/10 –	ATE	TP.A-079 TP.A-091	17,5 18,2			
S 80 II Sedan (AS) 2,0	01/08 –	ATE	TP.A-079 TP.A-091	17,5 18,2			
S 80 II Sedan (AS) 2,0 Flex Fuel	01/08 –	ATE	TP.A-079 TP.A-091	17,5 18,2			
S 80 II Sedan (AS) 2,0 TDi (T)	02/08 –	ATE	TP.A-079 TP.A-091	17,5 18,2			
S 80 II Sedan (AS) 2,4 D	03/06 –	ATE	TP.A-079 TP.A-091	17,5 18,2			
S 80 II Sedan (AS) 2,5 T	03/06 –	ATE	TP.A-079 TP.A-091	17,5 18,2			
S 80 II Sedan (AS) 2,5 T Flex Fuel	05/08 –	ATE	TP.A-079 TP.A-091	17,5 18,2			
S 80 II Sedan (AS) 3,2	03/06 –	ATE	TP.A-079 TP.A-091	17,5 18,2			
S 80 II Sedan (AS) 3,2 AWD	01/07 –	ATE	TP.A-079 TP.A-091	17,5 18,2			
S 80 II Sedan (AS) 4,4 V8 AWD	03/06 –	ATE	TP.A-079 TP.A-091	17,5 18,2			
S 80 II Sedan (AS) D3	01/10 –	ATE	TP.A-079 TP.A-091	17,5 18,2			
S 80 II Sedan (AS) D5	03/06 –	ATE	TP.A-079 TP.A-091	17,5 18,2			
S 80 II Sedan (AS) D5 AWD	01/07 –	ATE	TP.A-079 TP.A-091	17,5 18,2			

Марка автомобиля	Годы выпуска автомобиля	Передние колодки			Задние колодки		
		Тип тормозной системы	№ по каталогу	Толщина изделия, мм	Тип тормозной системы	№ по каталогу	Толщина изделия, мм
VOLVO							
S 80 II Sedan (AS) T4	10/10 –	ATE	TP.A-079 TP.A-091	17,5 18,2			
S 80 II Sedan (AS) T4F	05/11 –	ATE	TP.A-079 TP.A-091	17,5 18,2			
S 80 II Sedan (AS) T5	10/10 –	ATE	TP.A-079 TP.A-091	17,5 18,2			
S 80 II Sedan (AS) T6 AWD	01/07 –	ATE	TP.A-079 TP.A-091	17,5 18,2			
V 60 1,6 DRIVe	06/11 –	ATE	TP.A-079 TP.A-091	17,5 18,2			
V 60 2,0 T	09/10 –	ATE	TP.A-079 TP.A-091	17,5 18,2			
V 60 2,4 D5 (D5 AWD)	06/11 –	ATE	TP.A-079 TP.A-091	17,5 18,2			
V 60 2,4 Hybrid AWD	06/12 –	ATE	TP.A-079 TP.A-091	17,5 18,2			
V 60 D3 / D4	09/10 –	ATE	TP.A-079 TP.A-091	17,5 18,2			
V 60 D4 AWD	12/12 –	ATE	TP.A-079 TP.A-091	17,5 18,2			
V 60 D5 (D5 AWD)	09/10 –	ATE	TP.A-079 TP.A-091	17,5 18,2			
V 60 T3 / T4	09/10 –	ATE	TP.A-079 TP.A-091	17,5 18,2			
V 60 T4F	04/11 –	ATE	TP.A-079 TP.A-091	17,5 18,2			
V 60 T5	09/10 –	ATE	TP.A-079 TP.A-091	17,5 18,2			
V 60 T6 AWD	09/10 –	ATE	TP.A-079 TP.A-091	17,5 18,2			
V 70 I Estate (P80-) 2.4 D5	11/96-05/00	ATE	TP.A-079				
V 70 I Estate (P80-) 2.4 D5 16"	08/01-	ATE	TP.A-079				
V 70 I Estate (P80-)2.4 D5 16" Ø300,0 mm	08/07-	ATE	TP.A-079				
V 70 I Estate (P80-)2.4 D5 16" Ø305,0 mm	08/07-	ATE	TP.A-079				
V 70 I Estate (P80-)2.4 D5 16" Ø319,8 mm	08/07-	ATE	TP.A-079				
V 70 I Estate (P80-) 3,0 TAWD, 16"	08/07-	ATE	TP.A-079				
V 70 I Estate (P80-) 3,2, 16"	08/07-	ATE	TP.A-079				
V 70 III (BW) 1,6 D	01/10 –	ATE	TP.A-079 TP.A-091	17,5 18,2			
V 70 III (BW) 1,6 DRIVe / D2	06/11 –	ATE	TP.A-079 TP.A-091	17,5 18,2			
V 70 III (BW) 1,6 T4F	01/11 –	ATE	TP.A-079 TP.A-091	17,5 18,2			
V 70 III (BW) 2,0 Flexi Fuel	01/08 –	ATE	TP.A-079 TP.A-091	17,5 18,2			
V 70 III (BW) 2,0 T	01/10 –	ATE	TP.A-079 TP.A-091	17,5 18,2			
V 70 III (BW) D3	03/10 –	ATE	TP.A-079 TP.A-091	17,5 18,2			
V 70 III (BW) D4 (D4 AWD)	01/13 –	ATE	TP.A-079 TP.A-091	17,5 18,2			

Марка автомобиля	Годы выпуска автомобиля	Передние колодки			Задние колодки		
		Тип тормозной системы	№ по каталогу	Толщина изделия, мм	Тип тормозной системы	№ по каталогу	Толщина изделия, мм
VOLVO							
V 70 III (BW) D5 (D5 AWD)	08/07 –	ATE	TP.A-079 TP.A-091	17,5 18,2			
V 70 III (BW) T4 / T5	01/10 –	ATE	TP.A-079 TP.A-091	17,5 18,2			
V 70 III (BW) T6 AWD	08/07 –	ATE	TP.A-079 TP.A-091	17,5 18,2			
V 70 III Estate 2.0 16"	10/07-	ATE	TP.A-079				
V 70 III Estate 2.0 D, 16"	10/07-	ATE	TP.A-079				
V 70 III Estate 2,4 D 16"	08/07-	ATE	TP.A-079				
V 70 III Estate 2,4 D5 16"	08/07-	ATE	TP.A-079				
V 70 III Estate 2,4 D5 AWD 16"	10/07-	ATE	TP.A-079				
V 70 III Estate 2,5 T, 16"	08/07-	ATE	TP.A-079				
V 70 III Estate 2,5 T, 16"	08/07-	ATE	TP.A-079	17,5			
V 70 III Estate 2,5 T Flex Fuel, 16"	05/08-	ATE	TP.A-079	17,5			
V 70 III Estate 3,0 T6 AWD	08/07-	ATE	TP.A-079	17,5			
V 70 III Estate 3,2 16"	08/07-	ATE	TP.A-079	17,5			
V 70 III Estate 3,2 AWD, 16"	08/07-	ATE	TP.A-079	17,5			
XC 70 II 2.4 D5 AWD 16"	08/07-	ATE	TP.A-079	17,5			
XC 70 II 3.2 AWD 16"	08/07-	ATE	TP.A-079	17,5			
XC 70 II D3 (D3 AWD)	08/11 –	ATE	TP.A-079 TP.A-091	17,5 18,2			
XC 70 II D5 AWD	08/07 –	ATE	TP.A-079 TP.A-091	17,5 18,2			
XC 70 II T6 AWD	01/08 –	ATE	TP.A-079 TP.A-091	17,5 18,2			
XC 70 II Estate 2,4 D (D AWD)	08/07 –	ATE	TP.A-079 TP.A-091	17,5 18,2			
XC 70 II Estate 3,2 AWD	08/07 –	ATE	TP.A-079 TP.A-091	17,5 18,2			
XC 70 II Estate D3 (D3 AWD)	08/11 –	ATE	TP.A-079 TP.A-091	17,5 18,2			
XC 70 II Estate D5 AWD	08/07 –	ATE	TP.A-079 TP.A-091	17,5 18,2			
XC 70 II Estate T6 AWD	01/08 –	ATE	TP.A-079 TP.A-091	17,5 18,2			
YUGO							
Florida 1,3 All Models	89-93	GIR	TR.A-012	17,0			
Florida 1,4 GL, LS	89-93	GIR	TR.A-012	17,0			
Florida 1,4i GL, LS	89-93	GIR	TR.A-012	17,0			
Sana 1,4 GL,LS	89-93	GIR	TR.A-012	17,0			
Sana 1,4i GL, LS	89-93	GIR	TR.A-012	17,0			
ZASTAVA							
Florida (103A) 1.3 EF1	91-93	GIR	TP.A-003	19,4			
Florida (103A) 1,4	88-93	GIR	TP.A-003	19,4			
Sana 1.4	89-93	GIR	TP.A-012	17,0			

**КАТАЛОГ
КОЛОДОК ДИСКОВЫХ ТОРМОЗОВ
ПРОИЗВОДСТВА АО «ТИИР»
ДЛЯ ГРУЗОВЫХ АВТОМОБИЛЕЙ,
ПРИЦЕПОВ И АВТОБУСОВ ЗАРУБЕЖ-
НОГО ПРОИЗВОДСТВА**



	Годы выпуска автомобиля						
		Тип тормозной системы	№ по каталогу	Толщина изделия, мм	Тип тормозной системы	№ по каталогу	Толщина изделия, мм



BOVA

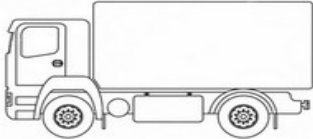

Futura (340, 381, 428 л.с.)	2001 –	KNORRS B 7000	TP.A-115	30,0	KNORRS B 7000	TP.A-115	30,0
Futura (310, 360 л.с.)	2006 –	KNORRS B 7000	TP.A-115	30,0	KNORRS B 7000	TP.A-115	30,0
Lexio (310, 360л.с.)	2005 –	KNORRS B 7000	TP.A-115	30,0	KNORRS B 7000	TP.A-115	30,0
Magiq(340, 381, 428л.с.)	1999 –	KNORRS B 7000	TP.A-115	30,0	KNORRS B 7000	TP.A-115	30,0
Magiq(408л.с.)	2006 –	KNORRS B 7000	TP.A-115	30,0	KNORRS B 7000	TP.A-115	30,0
Magiq(462л.с.)	2007 –	KNORRS B 7000	TP.A-115	30,0	KNORRS B 7000	TP.A-115	30,0
Synergy (428, 483л.с.)	2004 –	KNORRS B 7000	TP.A-115	30,0	KNORRS B 7000	TP.A-115	30,0
Synergy (462, 510л.с.)	2007 –	KNORRS B 7000	TP.A-115	30,0	KNORRS B 7000	TP.A-115	30,0

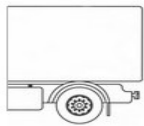
BPW (прицепы)

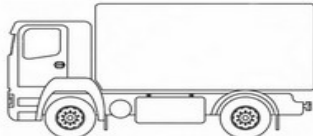
SH	01/96–				KNORR SB 4309T	TP.A-121	30,0
SH BF 9010 ECO Plus	01/00–				KNORR SB 4309T	TP.A-121	30,0
SHSF 10010-15 ECO	01/96–				KNORR SB 4309T	TP.A-121	30,0
SHSF 10010-15 ECO Plus	01/96–				KNORR SB 4309T	TP.A-121	30,0
SHSF 10010-15 ECO-MAXX	01/96–				KNORR SB 4309T	TP.A-121	30,0
SH SF 10110-15 ECO	01/96–				KNORR SB 4309T	TP.A-121	30,0
SHSF 10110-15 ECO Plus	01/96–				KNORR SB 4309T	TP.A-121	30,0
SHSF 10110-15 ECO-MAXX	01/96–				KNORR SB 4309T	TP.A-121	30,0
SHSF 12010-16 ECO Plus	01/96–				KNORR SB 4309T	TP.A-121	30,0
SHSF 12010-16 ECO-MAXX	01/96–				KNORR SB 4309T	TP.A-121	30,0
SH SF 8010 ECO Plus	01/96– 01/00				KNORR SB 4309T	TP.A-121	30,0
SH SF 9010	01/96–				KNORR SB 4309T	TP.A-121	30,0

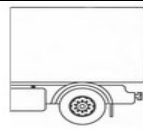
	Годы выпуска автомобиля						
		Тип тормозной системы	№ по каталогу	Толщина изделия, мм	Тип тормозной системы	№ по каталогу	Толщина изделия, мм
BPW (прицепы)							
SH SF 9010 ECO	01/96–				KNORR SB 4309T	TP.A-121	30,0
SHSF 9010 ECO Plus	01/96–				KNORR SB 4309T	TP.A-121	30,0
SHSF 9010 ECO Plus	01/00–				KNORR SB 4309T	TP.A-121	30,0
SHSF 9010 ECO-MAXX	01/96–				KNORR SB 4309T	TP.A-121	30,0
SH SF 9010-15 ECO	01/96–				KNORR SB 4309T	TP.A-121	30,0
SHSF 9010-15 ECO Plus	01/96–				KNORR SB 4309T	TP.A-121	30,0
SHSF 9010-15 ECO-MAXX	01/96–				KNORR SB 4309T	TP.A-121	30,0
SHSFA 8010 ECO-MAXX	01/96–				KNORR SB 4309T	TP.A-121	30,0
SH SFA 9010 ECO	01/96–				KNORR SB 4309T	TP.A-121	30,0
SHSFA 9010 ECO-MAXX	01/96–				KNORR SB 4309T	TP.A-121	30,0
SHSFA 9010-15 ECO-MAXX	01/96–				KNORR SB 4309T	TP.A-121	30,0
SH SFH 9010 ECO-MAXX	01/97–				KNORR SB 4309T	TP.A-121	30,0
SH SM 10010-15 ECO	01/96–				KNORR SB 4309T	TP.A-121	30,0
SHSM 10010-15 ECO Plus	01/96–				KNORR SB 4309T	TP.A-121	30,0
SHSM 10010-15 ECO-MAXX	01/96–				KNORR SB 4309T	TP.A-121	30,0
SH SM 10110-15 ECO	01/96–				KNORR SB 4309T	TP.A-121	30,0
SHSM 10110-15 ECO Plus	01/96–				KNORR SB 4309T	TP.A-121	30,0
SHSM 10110-15 ECO-MAXX	01/96–				KNORR SB 4309T	TP.A-121	30,0
SHSM 12010-16 ECO Plus	01/96–				KNORR SB 4309T	TP.A-121	30,0
SHSM 12010-16 ECO-MAXX	01/96–				KNORR SB 4309T	TP.A-121	30,0
SH SM 9010 ECO	01/96–				KNORR SB 4309T	TP.A-121	30,0
SHSM 9010 ECO Plus	01/00 –				KNORR SB 4309T	TP.A-121	30,0
SHSM 9010 ECO-MAXX	01/96–				KNORR SB 4309T	TP.A-121	30,0

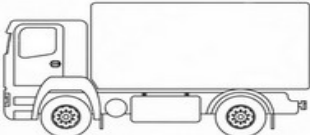
	Годы выпуска автомобиля						
		Тип тормозной системы	№ по каталогу	Толщина изделия, мм	Тип тормозной системы	№ по каталогу	Толщина изделия, мм
BPW (прицепы)							
SHSM 9010-15 ECOPlus	01/00 –				KNORR SB 4309T	TP.A-121	30,0
SHSM 9010-15 ECO-MAXX	01/96–				KNORR SB 4309T	TP.A-121	30,0
SH SMA 9010 ECO	01/96–				KNORR SB 4309T	TP.A-121	30,0
SHZ 12010-16 ECO-MAXX	01/96–				KNORR SB 4309T	TP.A-121	30,0
SH ZF 10010-15 ECO	01/96–				KNORR SB 4309T	TP.A-121	30,0
SHZF 10010-15 ECO Plus	01/96–				KNORR SB 4309T	TP.A-121	30,0
SHZF 10010-15 ECO-MAXX	01/96–				KNORR SB 4309T	TP.A-121	30,0
SH ZF 10110-15 ECO	01/96–				KNORR SB 4309T	TP.A-121	30,0
SHZF 10110-15 ECO Plus	01/96–				KNORR SB 4309T	TP.A-121	30,0
SHZF 10110-15 ECO-MAXX	01/96–				KNORR SB 4309T	TP.A-121	30,0
SHZF 12010-16 ECO Plus	01/96–				KNORR SB 4309T	TP.A-121	30,0
SHZF 12010-16 ECO-MAXX	01/96–				KNORR SB 4309T	TP.A-121	30,0
SHZF 14010-1 ECO-MAXX	01/96–				KNORR SB 4309T	TP.A-121	30,0
SHZF 14010-15 ECO-MAXX	01/96–				KNORR SB 4309T	TP.A-121	30,0
SH ZF 9010 ECO	01/96–				KNORR SB 4309T	TP.A-121	30,0
SHZF 9010 ECO Plus	01/96 –				KNORR SB 4309T	TP.A-121	30,0
SHZF 9010 ECO-MAXX	01/96–				KNORR SB 4309T	TP.A-121	30,0
SH ZF 9010-15 ECO	01/96–				KNORR SB 4309T	TP.A-121	30,0
SHZF 9010-15 ECO Plus	01/96–				KNORR SB 4309T	TP.A-121	30,0
SHZF 9010-15 ECO-MAXX	01/96–				KNORR SB 4309T	TP.A-121	30,0
SH ZM 10010-15 ECO	01/96–				KNORR SB 4309T	TP.A-121	30,0
SHZM 10010-15 ECO-MAXX	01/96–				KNORR SB 4309T	TP.A-121	30,0
SH ZM 10110-15 ECO	01/96–				KNORR SB 4309T	TP.A-121	30,0

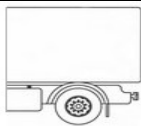
	Годы выпуска автомобиля						
		Тип тормозной системы	№ по каталогу	Толщина изделия, мм	Тип тормозной системы	№ по каталогу	Толщина изделия, мм
BPW (прицепы)							
SHZM 10110-15 ECO Plus	01/96–				KNORR SB 4309T	TP.A-121	30,0
SHZM 10110-15 ECO-MAXX	01/96–				KNORR SB 4309T	TP.A-121	30,0
SHZM 12010-16 ECO Plus	01/96–				KNORR SB 4309T	TP.A-121	30,0
SHZM 12010-16 ECO-MAXX	01/96–				KNORR SB 4309T	TP.A-121	30,0
SHZM 9010-15 ECO Plus	01/96–				KNORR SB 4309T	TP.A-121	30,0
SHZM 9010-15 ECO-MAXX	01/96–				KNORR SB 4309T	TP.A-121	30,0
SHZMA 9010-15 ECO-MAXX	01/96–				KNORR SB 4309T	TP.A-121	30,0
SKH 9008	1998 –				KNORR SB 3745T (SB7)	TP.A-122	29,8
SKH 9010	1998 –				KNORR SB 3745T (SB7)	TP.A-122	29,8
SKH B 9010	1998 –				KNORR SB 3745T (SB7)	TP.A-122	29,8
SKH BF 9010 ECO Plus	2000 –				KNORR SB 3745T (SB7)	TP.A-122	29,8
SKH BF 9010 ECO-MAXX	2000 –				KNORR SB 3745T (SB7)	TP.A-122	29,8
SKH BF 9010-15 ECO Plus	2000 –				KNORR SB 3745T (SB7)	TP.A-122	29,8
SKH BF 9010-15 ECO-MAXX	1998 –				KNORR SB 3745T (SB7)	TP.A-122	29,8
SKH BFHLL 9010 ECO Plus	1998 –				KNORR SB 3745T (SB7)	TP.A-122	29,8
SKH BFHLL 9010 ECO-MAXX	1998 –				KNORR SB 3745T (SB7)	TP.A-122	29,8
SKH BM 9010 ECO Plus	2000 –				KNORR SB 3745T (SB7)	TP.A-122	29,8

	Годы выпуска автомобиля						
		Тип тормозной системы	№ по каталогу	Толщина изделия, мм	Тип тормозной системы	№ по каталогу	Толщина изделия, мм
BPW (прицепы)							
SKH BM 9010-15 ECO Plus	2000 –				KNORR SB 3745T (SB7)	TP.A-122	29,8
SKH BM 9010-15 ECO-MAXX	1998 –				KNORR SB 3745T (SB7)	TP.A-122	29,8
SKH BMHLL 9010 ECO Plus	1998 –				KNORR SB 3745T (SB7)	TP.A-122	29,8
SKH BMHLL 9010 ECO-MAXX	1998 –				KNORR SB 3745T (SB7)	TP.A-122	29,8
SKH SF 10008-15 ECO Plus	1998 –				KNORR SB 3745T (SB7)	TP.A-122	29,8
SKH SF 10008-15 ECO-MAXX	1998 –				KNORR SB 3745T (SB7)	TP.A-122	29,8
SKH SF 10010-15 ECO Plus	1998 –				KNORR SB 3745T (SB7)	TP.A-122	29,8
SKH SF 10010-15 ECO-MAXX	1998 –				KNORR SB 3745T (SB7)	TP.A-122	29,8
SKH SF 8010 ECO-MAXX	1998 –				KNORR SB 3745T (SB7)	TP.A-122	29,8
SKH SF 9008 ECO	1998 –				KNORR SB 3745T (SB7)	TP.A-122	29,8
SKH SF 9008 ECO Plus	2000 –				KNORR SB 3745T (SB7)	TP.A-122	29,8
SKH SF 9008 ECO-MAXX	1998 –				KNORR SB 3745T (SB7)	TP.A-122	29,8
SKH SF 9008-15 ECO-MAXX	1998 –				KNORR SB 3745T (SB7)	TP.A-122	29,8
SKH SF 9008-15 ECO Plus	2000 –				KNORR SB 3745T (SB7)	TP.A-122	29,8
SKH SF 9010 ECO Plus	2000 –				KNORR SB 3745T (SB7)	TP.A-122	29,8
SKH SF 9010 ECO-MAXX	1998 –				KNORR SB 3745T (SB7)	TP.A-122	29,8



	Годы выпуска автомобиля						
		Тип тормозной системы	№ по каталогу	Толщина изделия, мм	Тип тормозной системы	№ по каталогу	Толщина изделия, мм

BPW (прицепы)

SKH ZF 9010-15 ECO Plus	2000 –				KNORR SB 3745T (SB7)	TP.A-122	29,8
SKH ZF 9010-15 ECO-MAXX	1998 –				KNORR SB 3745T (SB7)	TP.A-122	29,8
SKH ZM 10008-15 ECO-MAXX	1998 –				KNORR SB 3745T (SB7)	TP.A-122	29,8
SKH ZM 10010-15 ECO-MAXX	1998 –				KNORR SB 3745T (SB7)	TP.A-122	29,8
SKH ZM 9010 ECO-MAXX	1998 –				KNORR SB 3745T (SB7)	TP.A-122	29,8

D.A.F.

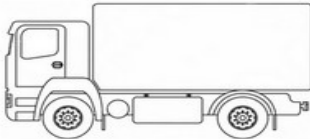
65 CF (181, 212, 241 л.с.)	1998 – 2000	KNORR SB 7000	TP.A-115	30,0	KNORR SB 7000	TP.A-115	30,0
75 CF (249, 288, 320 л.с.)	1998 – 2000	KNORR SB 7000	TP.A-115	30,0	KNORR SB 7000	TP.A-115	30,0
85 CF (340, 381, 428 л.с.)	1998 – 2000	KNORR SB 7000	TP.A-115	30,0	KNORR SB 7000	TP.A-115	30,0
95 XF (381, 428, 483, 530 л.с.)	1997 – 2002	KNORR SB 7000	TP.A-115	30,0	KNORR SB 7000	TP.A-115	30,0
CF 65 (185, 220, 250 л.с.)	2001 –	KNORR SB 7000	TP.A-115	30,0	KNORR SB 7000	TP.A-115	30,0
CF 75 (249, 310, 360 л.с.)	2001 –	KNORR SB 7000	TP.A-115	30,0	KNORR SB 7000	TP.A-115	30,0
CF 85 (340, 381, 428, 483 л.с.)	2001 –	KNORR SB 7000	TP.A-115	30,0	KNORR SB 7000	TP.A-115	30,0
LF FA 150 (PX-5 112) (152 л.с.)	2013 –	WABCO PAN 19-1	TP.A-124	29,5			
LF FA 180 (PX-5 135) (182 л.с.)	2013 –	WABCO PAN 19-1	TP.A-124	29,5			
LF FA 210 (PX-5 157) (212 л.с.)	2013 –	WABCO PAN 19-1	TP.A-124	29,5			
LF FA 220 (PX-7 164) (220 л.с.)	2013 –	WABCO PAN 19-1	TP.A-124	29,5			
LF FA 250 (PX-7 186) (254 л.с.)	2013 –	WABCO PAN 19-1	TP.A-124	29,5			
LF FA 280 (PX-7 208) (284 л.с.)	2013 –	WABCO PAN 19-1	TP.A-124	29,5			

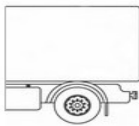
	Годы выпуска автомобиля						
		Тип тормозной системы	№ по каталогу	Толщина изделия, мм	Тип тормозной системы	№ по каталогу	Толщина изделия, мм
D.A.F.							
LF FA 310 (PX-7 231) (314 л.с.)	2013 –	WABCO PAN 19-1	TP.A-124	29,5			
LF 45 FA 45.140 (FR 103 S1) (140 л.с.)	2006 –				WABCO PAN 19-1	TP.A-124	29,5
LF 55 (167, 185, 220, 250 л.с.)	2001 –	KNORR SB 7000	TP.A-115	30,0	KNORR SB 7000	TP.A-115	30,0
LF 55 (180, 224, 286 л.с.)	2006 –	KNORR SB 7000	TP.A-115	30,0	KNORR SB 7000	TP.A-115	30,0
LF 55 FA 55.160 (Автомобиль для нужд коммунального хозяйства) (160 л.с.)	05/2006 –	WABCO PAN 19-1	TP.A-124	29,5			
LF 55 FA 55.160 (Грузовик с бортовой платформой/шасси) (160 л.с.)	05/2006 –	WABCO PAN 19-1	TP.A-124	29,5			
LF 55 FA 55.170 (Грузовик с бортовой платформой/шасси) (167 л.с.)	01/2001 –	WABCO PAN 19-1	TP.A-124	29,5			
LF 55 FA 55.180 (Автомобиль для нужд коммунального хозяйства) (185 л.с.)	05/2006 –	WABCO PAN 19-1	TP.A-124	29,5			
LF 55 FA 55.180 (Грузовик с бортовой платформой/шасси) (185 л.с.)	01/2001 –	WABCO PAN 19-1	TP.A-124	29,5			
LF 55 FA 55.180 (Грузовик с бортовой платформой/шасси) (185 л.с.)	05/2006 –	WABCO PAN 19-1	TP.A-124	29,5			
LF 55 FA 55.210 (Автомобиль для нужд коммунального хозяйства) (207 л.с.)	01/2009 –	WABCO PAN 19-1	TP.A-124	29,5			
LF 55 FA 55.210 (Грузовик с бортовой платформой/шасси) (207 л.с.)	01/2009 –	WABCO PAN 19-1	TP.A-124	29,5			
LF 55 FA 55.220 (Автомобиль для нужд коммунального хозяйства) (224 л.с.)	05/2006 –	WABCO PAN 19-1	TP.A-124	29,5			
LF 55 FA 55.220 (Грузовик с бортовой платформой/шасси) (220 л.с.)	01/2001 –	WABCO PAN 19-1	TP.A-124	29,5			
LF 55 FA 55.220 (Грузовик с бортовой платформой/шасси) (224 л.с.)	05/2006 –	WABCO PAN 19-1	TP.A-124	29,5			
LF 55 FA 55.250 (Грузовик с бортовой платформой/шасси) (250 л.с.)	05/2006 –	WABCO PAN 19-1	TP.A-124	29,5			
LF 55 FA 55.250 (Грузовик с бортовой платформой/шасси) (250 л.с.)	01/2001 –	WABCO PAN 19-1	TP.A-124	29,5			

	Годы выпуска автомобиля						
		Тип тормозной системы	№ по каталогу	Толщина изделия, мм	Тип тормозной системы	№ по каталогу	Толщина изделия, мм

D.A.F.

LF 55 FA 55.280 (Грузовик с бортовой платформой/шасси) (286 л.с.)	05/2006 –	WABCO PAN 19-1	TP.A-124	29,5			
LF 55 FA 55.290 (Грузовик с бортовой платформой/шасси) (286 л.с.)	05/2006 –	WABCO PAN 19-1	TP.A-124	29,5			
LF 55 FA 55.300 (Грузовик с бортовой платформой/шасси) (300 л.с.)	01/2009 –	WABCO PAN 19-1	TP.A-124	29,5			
LF 55 FAN 55.220 (Грузовик с бортовой платформой/шасси) (224 л.с.)	05/2006 –	WABCO PAN 19-1	TP.A-124	29,5			
LF 55 FAN 55.250 (Грузовик с бортовой платформой/шасси) (250 л.с.)	05/2006 –	WABCO PAN 19-1	TP.A-124	29,5			
LF 55 FAN 55.290 (Грузовик с бортовой платформой/шасси) (286 л.с.)	05/2006 –	WABCO PAN 19-1	TP.A-124	29,5			
LF 55 FT 55.180 (Седельный тягач) (185 л.с.)	01/2001 –	WABCO PAN 19-1	TP.A-124	29,5			
LF 55 FT 55.220 (Седельный тягач) (224 л.с.)	05/2006 –	WABCO PAN 19-1	TP.A-124	29,5			
LF 55 FT 55.220 (Седельный тягач) (220 л.с.)	01/2001 –	WABCO PAN 19-1	TP.A-124	29,5			
LF 55 FT 55.250 (Седельный тягач) (250 л.с.)	01/2001 –	WABCO PAN 19-1	TP.A-124	29,5			
LF 55 FT 55.250 (Седельный тягач) (250 л.с.)	05/2006 –	WABCO PAN 19-1	TP.A-124	29,5			
LF 55 FT 55.280 (Седельный тягач) (286 л.с.)	05/2006 –	WABCO PAN 19-1	TP.A-124	29,5			
LF 55 FT 55.290 (Седельный тягач) (286 л.с.)	05/2006 –	WABCO PAN 19-1	TP.A-124	29,5			
XF 95 (381, 428, 483, 530 л.с.)	2002 – 2006	KNORR SB 7000	TP.A-115	30,0	KNORR SB 7000	TP.A-115	30,0
XF 105 (408, 462, 510 л.с.)	2005 –	KNORR SB 7000	TP.A-115	30,0	KNORR SB 7000	TP.A-115	30,0

DENNIS

Olympus (260 л.с.)	2009 –	KNORR SB 7000	TP.A-115	30,0	KNORR SB 7000	TP.A-115	30,0
Olympus (301 л.с.)	2009 –	KNORR SB 7000	TP.A-115	30,0	KNORR SB 7000	TP.A-115	30,0

	Годы выпуска автомобиля						
		Тип тормозной системы	№ по каталогу	Толщина изделия, мм	Тип тормозной системы	№ по каталогу	Толщина изделия, мм

DENNIS



Olympus OL-10N, OL-13W, OL-16W (D7F260) (260 л.с.)	2009 –	WABCO PAN 19-1	TP.A-124	29,5	WABCO PAN 19-1	TP.A-124	29,5
Olympus OL-10N, OL-13W, OL-16W (D7F300) (301 л.с.)	2009 –	WABCO PAN 19-1	TP.A-124	29,5	WABCO PAN 19-1	TP.A-124	29,5
Olympus OL-14N, OL-16W (D7F260) (260 л.с.)	2009 –	WABCO PAN 19-1	TP.A-124	29,5	WABCO PAN 19-1	TP.A-124	29,5
Olympus OL-14N, OL-16W (D7F300) (301 л.с.)	2009 –	WABCO PAN 19-1	TP.A-124	29,5	WABCO PAN 19-1	TP.A-124	29,5
Olympus OL-16N, OL-19W (D7F260) (260 л.с.)	2009 –	WABCO PAN 19-1	TP.A-124	29,5	WABCO PAN 19-1	TP.A-124	29,5
Olympus OL-16N, OL-19W (D7F300) (301 л.с.)	2009 –	WABCO PAN 19-1	TP.A-124	29,5	WABCO PAN 19-1	TP.A-124	29,5
Olympus OL-19N, OL-21W, OL-23W (D7F260) (260 л.с.)	2009 –	WABCO PAN 19-1	TP.A-124	29,5	WABCO PAN 19-1	TP.A-124	29,5
Olympus OL-19N, OL-21W, OL 23W (D7F300) (301 л.с.)	2009 –	WABCO PAN 19-1	TP.A-124	29,5	WABCO PAN 19-1	TP.A-124	29,5
Olympus OL-19W, OL-21W, OL-23W (D7F260) (260 л.с.)	2009 –	WABCO PAN 19-1	TP.A-124	29,5	WABCO PAN 19-1	TP.A-124	29,5
Olympus OL-19W, OL-21W, OL 23W (D7F300) (301 л.с.)	2009 –	WABCO PAN 19-1	TP.A-124	29,5	WABCO PAN 19-1	TP.A-124	29,5



GIGANT Protec

Protec DH6 10008 3745	2001 –				WABCO PAN 22,5	TP.A-123	31,7
Protec DNH6 10008 3745	2000 –				WABCO PAN 22,5	TP.A-123	31,7

IVECO

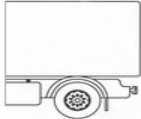
EuroCargo (209, 240, 275 л.с.)	2000 –	KNORR SB 7000	TP.A-115	30,0	KNORR SB 7000	TP.A-115	30,0
EuroCargo (218, 252 л.с.)	2006 –	KNORR SB 7000	TP.A-115	30,0	KNORR SB 7000	TP.A-115	30,0
EuroCargo (251 л.с.)	2009 –	KNORR SB 7000	TP.A-115	30,0	KNORR SB 7000	TP.A-115	30,0
EuroStar (375, 420, 430 л.с.)	1993 – 2002	KNORR SB 7000	TP.A-115	30,0	KNORR SB 7000	TP.A-115	30,0
EuroStar (390 л.с.)	1999 – 2002	KNORR SB 7000	TP.A-115	30,0	KNORR SB 7000	TP.A-115	30,0
EuroStar (400 л.с.)	2000 – 2002	KNORR SB 7000	TP.A-115	30,0	KNORR SB 7000	TP.A-115	30,0

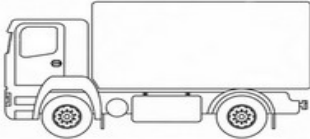
	Годы выпуска автомобиля						
		Тип тормозной системы	№ по каталогу	Толщина изделия, мм	Тип тормозной системы	№ по каталогу	Толщина изделия, мм
IVECO							
EuroTech MH (245, 272, 310, 352 л.с.)	1998 –	KNORR SB 7000	TP.A-115	30,0	KNORR SB 7000	TP.A-115	30,0
EuroTech MH (296 л.с.)	2000 –	KNORR SB 7000	TP.A-115	30,0	KNORR SB 7000	TP.A-115	30,0
EuroTech MP (420 л.с.)	1992 – 1993	KNORR SB 7000	TP.A-115	30,0	KNORR SB 7000	TP.A-115	30,0
EuroTech MP (345, 375 л.с.)	1992 – 1996	KNORR SB 7000	TP.A-115	30,0	KNORR SB 7000	TP.A-115	30,0
EuroTech MP (301 л.с.)	1997 –	KNORR SB 7000	TP.A-115	30,0	KNORR SB 7000	TP.A-115	30,0
EuroTech MP (390, 430 л.с.)	1999 –	KNORR SB 7000	TP.A-115	30,0	KNORR SB 7000	TP.A-115	30,0
EuroTech MP (400 л.с.)	2000 –	KNORR SB 7000	TP.A-115	30,0	KNORR SB 7000	TP.A-115	30,0
EuroTech MP (437, 456, 477, 481, 507, 509, 526, 558, 589 л.с.)	2002 –	KNORR SB 7000	TP.A-115	30,0	KNORR SB 7000	TP.A-115	30,0
EuroTech MT (239, 267, 301, 345 л.с.)	1992 – 1998	KNORR SB 7000	TP.A-115	30,0	KNORR SB 7000	TP.A-115	30,0
Stralis (400, 430, 480, 540 л.с.)	2002 –	KNORR SB 7000	TP.A-115	30,0	KNORR SB 7000	TP.A-115	30,0
Stralis (272, 296, 310, 352 л.с.)	2003 –	KNORR SB 7000	TP.A-115	30,0	KNORR SB 7000	TP.A-115	30,0
Stralis (330, 420, 422, 450, 500, 560 л.с.)	2006 –	KNORR SB 7000	TP.A-115	30,0	KNORR SB 7000	TP.A-115	30,0
Stralis (360 л.с.)	2007 –	KNORR SB 7000	TP.A-115	30,0	KNORR SB 7000	TP.A-115	30,0
Stralis (272 л.с.)	2008 –	KNORR SB 7000	TP.A-115	30,0	KNORR SB 7000	TP.A-115	30,0
Trakker (310, 352, 360, 380, 440 л.с.)	2004 –	KNORR SB 7000	TP.A-115	30,0	KNORR SB 7000	TP.A-115	30,0
Trakker (272, 420 л.с.)	2005 –	KNORR SB 7000	TP.A-115	30,0	KNORR SB 7000	TP.A-115	30,0
Trakker (330, 410, 450 л.с.)	2006 –	KNORR SB 7000	TP.A-115	30,0	KNORR SB 7000	TP.A-115	30,0
MAN							
TGA (310, 360, 410, 430, 460, 510 л.с.)	2000 –	KNORR SB 7000	TP.A-115	30,0	KNORR SB 7000	TP.A-115	30,0
TGA (530 л.с.)	2001 –	KNORR SB 7000	TP.A-115	30,0	KNORR SB 7000	TP.A-115	30,0
TGA (280, 326, 480, 660 л.с.)	2002 –	KNORR SB 7000	TP.A-115	30,0	KNORR SB 7000	TP.A-115	30,0

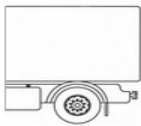

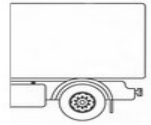
	Годы выпуска автомобиля						
		Тип тормозной системы	№ по каталогу	Толщина изделия, мм	Тип тормозной системы	№ по каталогу	Толщина изделия, мм
MAN							
TGA (320, 350, 390, 400, 440 л.с.)	2004 –	KNORR SB 7000	TP.A-115	30,0	KNORR SB 7000	TP.A-115	30,0
TGA (540 л.с.)	2006 –	KNORR SB 7000	TP.A-115	30,0	KNORR SB 7000	TP.A-115	30,0
TGM (240, 250, 280, 290, 326 л.с.)	2005 –	KNORR SB 7000	TP.A-115	30,0	KNORR SB 7000	TP.A-115	30,0
TGM 12.240 FLC, FLLC (D 0836 LFL 50, D 0836 LFL 53) (240 л.с.)	2005 –	KNORR SB 3745T (SB7)	TP.A-122	29,8	KNORR SB 3745T (SB7)	TP.A-122	29,8
TGM 12.280 FC, FLC, FLLC (D 0836 LFL 51, D 0836 LFL 54) (280 л.с.)	2005 –	KNORR SB 3745T (SB7)	TP.A-122	29,8	KNORR SB 3745T (SB7)	TP.A-122	29,8
TGM 13.240 FAL, FALC, FALRC, FAEC, FAERC, FALR (D 0836 LFL 40, D 0836 LFL 50, D 0836 LFL 53) (240 л.с.)	2006 –	KNORR SB 3745T (SB7)	TP.A-122	29,8	KNORR SB 3745T (SB7)	TP.A-122	29,8
TGM 13.240 FALK, FALRK, FALK-L, FALRK-L (D 0836 LFL 40, D 0836 LFL 50, D 0836 LFL 53) (240 л.с.)	2006 –	KNORR SB 3745T (SB7)	TP.A-122	29,8	KNORR SB 3745T (SB7)	TP.A-122	29,8
TGM 13.250 FAEC, FAERC, FALC, FAL, FALRC, FALR (D 0836 LFL 63, D 0836 LFL 66) (250 л.с.)	2005 –	KNORR SB 3745T (SB7)	TP.A-122	29,8	KNORR SB 3745T (SB7)	TP.A-122	29,8
TGM 13.280 FALK, FALRK, FALK-L, FALRK-L (D 0836 LFL 41, D 0836 LFL 51, D 0836 LFL 54) (280 л.с.)	2006 –	KNORR SB 3745T (SB7)	TP.A-122	29,8	KNORR SB 3745T (SB7)	TP.A-122	29,8
TGM 15.240 FC, FLC, FLLC, FLRC, FLLRC (D 0836 LFL 40, D 0836 LFL 50, D 0836 LFL 53) (240 л.с.)	2005 –	KNORR SB 3745T (SB7)	TP.A-122	29,8	KNORR SB 3745T (SB7)	TP.A-122	29,8
TGM 15.280 FC, FLC, FLLC, FLRC, FLLRC (D 0836 LFL 41, D 0836 LFL 51, D 0836 LFL 54) (280 л.с.)	2005 –	KNORR SB 3745T (SB7)	TP.A-122	29,8	KNORR SB 3745T (SB7)	TP.A-122	29,8
TGS (320, 360, 400, 440 л.с.)	2007 –	KNORR SB 7000	TP.A-115	30,0	KNORR SB 7000	TP.A-115	30,0
TGS (441 л.с.)	2011 –	KNORR SB 7000	TP.A-115	30,0	KNORR SB 7000	TP.A-115	30,0
TGX (320, 360, 400, 440, 480 л.с.)	2007 –	KNORR SB 7000	TP.A-115	30,0	KNORR SB 7000	TP.A-115	30,0

	Годы выпуска автомобиля						
		Тип тормозной системы	№ по каталогу	Толщина изделия, мм	Тип тормозной системы	№ по каталогу	Толщина изделия, мм
MERCEDES-BENZ							
Actros (313, 354, 394, 428, 476, 530 л.с.)	1996 – 2002	KNORR SB 7000	TP.A-115	30,0	KNORR SB 7000	TP.A-115	30,0
Actros (313, 354, 394, 428, 456, 476, 571 л.с.)	1997 – 2002	KNORR SB 7000	TP.A-115	30,0	KNORR SB 7000	TP.A-115	30,0
Actros MP2 / MP3 (578 л.с.)	2002 –	KNORR SB 7000	TP.A-115	30,0	KNORR SB 7000	TP.A-115	30,0
Actros MP2 / MP3 (312, 313, 320, 354, 360, 394 л.с.)	2003 –	KNORR SB 7000	TP.A-115	30,0	KNORR SB 7000	TP.A-115	30,0
Actros MP2 / MP3 (401, 408, 428, 435, 456, 476 л.с.)	2003 –	KNORR SB 7000	TP.A-115	30,0	KNORR SB 7000	TP.A-115	30,0
Actros MP2 / MP3 (503, 510, 530, 537, 551, 598, 653 л.с.)	2003 –	KNORR SB 7000	TP.A-115	30,0	KNORR SB 7000	TP.A-115	30,0
Atego (231, 279 л.с.)	1998 – 2004	KNORR SB 7000	TP.A-115	30,0	KNORR SB 7000	TP.A-115	30,0
Axor (231, 279, 354, 401, 428 л.с.)	2002 – 2004	KNORR SB 7000	TP.A-115	30,0	KNORR SB 7000	TP.A-115	30,0
Axor 2 (231, 256, 279, 286, 326, 360 л.с.)	2004 –	KNORR SB 7000	TP.A-115	30,0	KNORR SB 7000	TP.A-115	30,0
Axor 2 (354, 401 л.с.)	2004 – 2005	KNORR SB 7000	TP.A-115	30,0	KNORR SB 7000	TP.A-115	30,0
Axor 2 (400 л.с.)	2009 –	KNORR SB 7000	TP.A-115	30,0	KNORR SB 7000	TP.A-115	30,0
Axor 2 (305 л.с.)	2011 –	KNORR SB 7000	TP.A-115	30,0	KNORR SB 7000	TP.A-115	30,0
Citaro (O 530) (231, 279, 299, 354 л.с.)	1998 –	KNORR SB 7000	TP.A-115	30,0	KNORR SB 7000	TP.A-115	30,0
Citaro (O 530) (177, 245 л.с.)	1999 –	KNORR SB 7000	TP.A-115	30,0	KNORR SB 7000	TP.A-115	30,0
Citaro (O 530) (252, 326 л.с.)	2000 –	KNORR SB 7000	TP.A-115	30,0	KNORR SB 7000	TP.A-115	30,0
Conecto (O 345) (214, 252, 279, 299, 354 л.с.)	2001 –	KNORR SB 7000	TP.A-115	30,0	KNORR SB 7000	TP.A-115	30,0
Econic (231, 238, 279 л.с.)	1998 –	KNORR SB 7000	TP.A-115	30,0	KNORR SB 7000	TP.A-115	30,0
Econic (279 л.с.)	2000 –	KNORR SB 7000	TP.A-115	30,0	KNORR SB 7000	TP.A-115	30,0
Econic (286 л.с.)	2001 –	KNORR SB 7000	TP.A-115	30,0	KNORR SB 7000	TP.A-115	30,0
Eje/Axle	01/96–	KNORR SB 4309T	TP.A-121	30,0	KNORR SB 4309T	TP.A-121	30,0

	Годы выпуска автомобиля						
		Тип тормозной системы	№ по каталогу	Толщина изделия, мм	Тип тормозной системы	№ по каталогу	Толщина изделия, мм

MERCEDES-BENZ

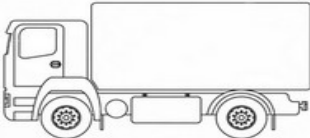
Integro (O 550) (286, 299, 300, 354, 408 л.с.)	2006 –	KNORR SB 7000	TP.A-115	30,0	KNORR SB 7000	TP.A-115	30,0
Intouro (286, 299, 354, 408 л.с.)	2005 –	KNORR SB 7000	TP.A-115	30,0	KNORR SB 7000	TP.A-115	30,0
Llanta 22,5DWP 5000 (SK7/MA7)	01/96–	KNORR SB 4309T	TP.A-121	30,0	KNORR SB 4309T	TP.A-121	30,0
MK (245, 272, 313, 330, 340л.с.)	1987 – 1996	KNORR SB 7000	TP.A-115	30,0	KNORR SB 7000	TP.A-115	30,0
NG (216 л.с.)	1981 – 1990	KNORR SB 7000	TP.A-115	30,0	KNORR SB 7000	TP.A-115	30,0
NG (280, 330, 354, 375, 435л.с.)	1973 – 1996	KNORR SB 7000	TP.A-115	30,0	KNORR SB 7000	TP.A-115	30,0
NG (355л.с.)	1981 – 1991	KNORR SB 7000	TP.A-115	30,0	KNORR SB 7000	TP.A-115	30,0
O 100 (95 л.с.)	1994 –	KNORR SB 7000	TP.A-115	30,0	KNORR SB 7000	TP.A-115	30,0
O 403 (354, 422 л.с.)	2003 –	KNORR SB 7000	TP.A-115	30,0	KNORR SB 7000	TP.A-115	30,0
OF Series (137, 170, 210л.с.)	1983 –	KNORR SB 7000	TP.A-115	30,0	KNORR SB 7000	TP.A-115	30,0
OH Series (156, 177, 193, 204, 216, 218, 245, 250, 256, 265, 280 л.с.)	1970 –	KNORR SB 7000	TP.A-115	30,0	KNORR SB 7000	TP.A-115	30,0
SK (447, 480л.с.)	1988 – 1992	KNORR SB 7000	TP.A-115	30,0	KNORR SB 7000	TP.A-115	30,0
SK (366л.с.)	1988 – 1993	KNORR SB 7000	TP.A-115	30,0	KNORR SB 7000	TP.A-115	30,0
SK (286, 462л.с.)	1988 – 1994	KNORR SB 7000	TP.A-115	30,0	KNORR SB 7000	TP.A-115	30,0
SK (354, 381, 435л.с.)	1987 – 1996	KNORR SB 7000	TP.A-115	30,0	KNORR SB 7000	TP.A-115	30,0
SK (492, 503л.с.)	1991 – 1996	KNORR SB 7000	TP.A-115	30,0	KNORR SB 7000	TP.A-115	30,0
SK (530л.с.)	1994 – 1996	KNORR SB 7000	TP.A-115	30,0	KNORR SB 7000	TP.A-115	30,0
Tourismo (O 350) (340, 381 л.с.)	1995 –	KNORR SB 7000	TP.A-115	30,0	KNORR SB 7000	TP.A-115	30,0
Tourismo (O 350) (252, 299, 354л.с.)	2003 –	KNORR SB 7000	TP.A-115	30,0	KNORR SB 7000	TP.A-115	30,0
Tourismo (O 350) (408, 422, 428, 435, 456, 476, 503л.с.)	2003 –	KNORR SB 7000	TP.A-115	30,0	KNORR SB 7000	TP.A-115	30,0
Touro (O 500) (245, 306, 326, 360, 401л.с.)	–	KNORR SB 7000	TP.A-115	30,0	KNORR SB 7000	TP.A-115	30,0

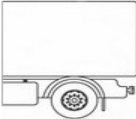
	Годы выпуска автомобиля						
		Тип тормозной системы	№ по каталогу	Толщина изделия, мм	Тип тормозной системы	№ по каталогу	Толщина изделия, мм
NEOPLAN							
Centroliner (220, 280 л.с.)	1998 –	KNORR SB 7000	TP.A-115	30,0	KNORR SB 7000	TP.A-115	30,0
Centroliner (260, 310 л.с.)	1999 – 2001	KNORR SB 7000	TP.A-115	30,0	KNORR SB 7000	TP.A-115	30,0
Centroliner (271 л.с.)	–	KNORR SB 7000	TP.A-115	30,0	KNORR SB 7000	TP.A-115	30,0
Cityliner (310, 370 л.с.)	1990 –	KNORR SB 7000	TP.A-115	30,0	KNORR SB 7000	TP.A-115	30,0
Cityliner (306, 311, 330 л.с.)	1990 – 1992	KNORR SB 7000	TP.A-115	30,0	KNORR SB 7000	TP.A-115	30,0
Cityliner (363 л.с.)	1990 – 1993	KNORR SB 7000	TP.A-115	30,0	KNORR SB 7000	TP.A-115	30,0
Cityliner (364, 381, 401, 420 л.с.)	1992 –	KNORR SB 7000	TP.A-115	30,0	KNORR SB 7000	TP.A-115	30,0
Cityliner (355 л.с.)	–	KNORR SB 7000	TP.A-115	30,0	KNORR SB 7000	TP.A-115	30,0
Cityliner (460 л.с.)	2004 –	KNORR SB 7000	TP.A-115	30,0	KNORR SB 7000	TP.A-115	30,0
Cityliner (400, 440 л.с.)	2006 –	KNORR SB 7000	TP.A-115	30,0	KNORR SB 7000	TP.A-115	30,0
Euroliner (360, 410 л.с.)	–	KNORR SB 7000	TP.A-115	30,0	KNORR SB 7000	TP.A-115	30,0
Jetliner (364 л.с.)	1992 – 1993	KNORR SB 7000	TP.A-115	30,0	KNORR SB 7000	TP.A-115	30,0
Jetliner (381, 401 л.с.)	1992 –	KNORR SB 7000	TP.A-115	30,0	KNORR SB 7000	TP.A-115	30,0
Megaliner (503 л.с.)	1993 –	KNORR SB 7000	TP.A-115	30,0	KNORR SB 7000	TP.A-115	30,0
Megashuttle(320 л.с.)	1994 –	KNORR SB 7000	TP.A-115	30,0	KNORR SB 7000	TP.A-115	30,0
Skyliner (340, 352, 355 л.с.)	1979 –	KNORR SB 7000	TP.A-115	30,0	KNORR SB 7000	TP.A-115	30,0
Skyliner(370 л.с.)	1990 –	KNORR SB 7000	TP.A-115	30,0	KNORR SB 7000	TP.A-115	30,0
Skyliner (306, 310, 311, 330, 420 л.с.)	1990 – 1992	KNORR SB 7000	TP.A-115	30,0	KNORR SB 7000	TP.A-115	30,0
Skyliner (363, 373 л.с.)	1990 – 1993	KNORR SB 7000	TP.A-115	30,0	KNORR SB 7000	TP.A-115	30,0
Skyliner (364, 381, 401 л.с.)	1992 –	KNORR SB 7000	TP.A-115	30,0	KNORR SB 7000	TP.A-115	30,0
Skyliner (530 л.с.)	2004 –	KNORR SB 7000	TP.A-115	30,0	KNORR SB 7000	TP.A-115	30,0



	Годы выпуска автомобиля						
		Тип тормозной системы	№ по каталогу	Толщина изделия, мм	Тип тормозной системы	№ по каталогу	Толщина изделия, мм



SAF

SKRB 9022 H (МК IV)	01/73 –				KNORR SB 4309T	TP.A-121	30,0
SKRB 9022 H (Modul X)	01/73 –				KNORR SB 4309T	TP.A-121	30,0
SKRB 9022 K	01/73 –				KNORR SB 4309T	TP.A-121	30,0
SKRB 9022 KI (SN7) Integral	01/73 –				KNORR SB 4309T	TP.A-121	30,0
SKRB 9022 KI 01 (SN7) Integral	01/73 –				KNORR SB 4309T	TP.A-121	30,0

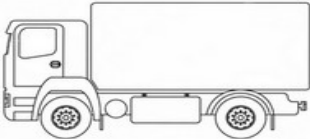

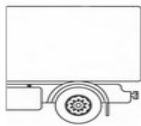
SCANIA

4-Series (360, 460, 530 л.с.)	1995 –	KNORR SB 7000	TP.A-115	30,0	KNORR SB 7000	TP.A-115	30,0
4-Series (220, 260, 300, 310, 340, 400, 420 л.с.)	1996 –	KNORR SB 7000	TP.A-115	30,0	KNORR SB 7000	TP.A-115	30,0
4-Series (230 л.с.)	1999 –	KNORR SB 7000	TP.A-115	30,0	KNORR SB 7000	TP.A-115	30,0
4-Series (380, 381 л.с.)	1998 –	KNORR SB 7000	TP.A-115	30,0	KNORR SB 7000	TP.A-115	30,0
4-Series (269, 299, 322, 379, 419, 469, 579 л.с.)	–	KNORRS B 7000	TP.A-115	30,0	KNORRS B 7000	TP.A-115	30,0
4-Series (480, 580 л.с.)	2000 –	KNORR SB 7000	TP.A-115	30,0	KNORR SB 7000	TP.A-115	30,0
4-Series (440, 470 л.с.)	2001 –	KNORR SB 7000	TP.A-115	30,0	KNORR SB 7000	TP.A-115	30,0
P,G,R,T-Series (260, 280, 300, 559, 579, 619 л.с.)	–	KNORRS B 7000	TP.A-115	30,0	KNORRS B 7000	TP.A-115	30,0
P,G,R,T-Series (230, 270, 310, 340, 380 л.с.)	2004 –	KNORR SB 7000	TP.A-115	30,0	KNORR SB 7000	TP.A-115	30,0
P,G,R,T-Series (420, 469, 500, 560, 580 л.с.)	2004 –	KNORR SB 7000	TP.A-115	30,0	KNORR SB 7000	TP.A-115	30,0
P,G,R,T-Series (470 л.с.)	2004 – 2005	KNORR SB 7000	TP.A-115	30,0	KNORR SB 7000	TP.A-115	30,0
P,G,R,T-Series (620 л.с.)	2005 –	KNORR SB 7000	TP.A-115	30,0	KNORR SB 7000	TP.A-115	30,0
P,G,R,T-Series (269, 381, 480 л.с.)	2006 –	KNORR SB 7000	TP.A-115	30,0	KNORR SB 7000	TP.A-115	30,0
P,G,R,T-Series (379, 400, 441 л.с.)	2008 –	KNORR SB 7000	TP.A-115	30,0	KNORR SB 7000	TP.A-115	30,0
P,G,R,T-Series (360 л.с.)	2009 –	KNORR SB 7000	TP.A-115	30,0	KNORR SB 7000	TP.A-115	30,0
P,G,R,T-Series (440, 730 л.с.)	2010 –	KNORR SB 7000	TP.A-115	30,0	KNORR SB 7000	TP.A-115	30,0

	Годы выпуска автомобиля						
		Тип тормозной системы	№ по каталогу	Толщина изделия, мм	Тип тормозной системы	№ по каталогу	Толщина изделия, мм
SETRA							
Series 400 (354, 408, 422, 456, 503 л.с.)	2001 –	KNORR SB 7000	TP.A-115	30,0	KNORR SB 7000	TP.A-115	30,0
Series 400 (435 л.с.)	2002 –	KNORR SB 7000	TP.A-115	30,0	KNORR SB 7000	TP.A-115	30,0
Series 400 (252, 299, 428, 476 л.с.)	2003 –	KNORR SB 7000	TP.A-115	30,0	KNORR SB 7000	TP.A-115	30,0
SOLARIS							
Alpino (250 л.с.)	2007 –	KNORR SB 7000	TP.A-115	30,0	KNORR SB 7000	TP.A-115	30,0
Urbino (155, 220, 249, 260, 310, 320, 350 л.с.)	1999 –	KNORR SB 7000	TP.A-115	30,0	KNORR SB 7000	TP.A-115	30,0
Urbino (250 л.с.)	2002 –	KNORR SB 7000	TP.A-115	30,0	KNORR SB 7000	TP.A-115	30,0
Urbino (340, 360 л.с.)	2006 –	KNORR SB 7000	TP.A-115	30,0	KNORR SB 7000	TP.A-115	30,0
Vacanza (340, 381 л.с.)	2002 – 2006	KNORR SB 7000	TP.A-115	30,0	KNORR SB 7000	TP.A-115	30,0
Vacanza (408 л.с.)	2005 –	KNORR SB 7000	TP.A-115	30,0	KNORR SB 7000	TP.A-115	30,0
Vacanza (428 л.с.)	2003 – 2006	KNORR SB 7000	TP.A-115	30,0	KNORR SB 7000	TP.A-115	30,0

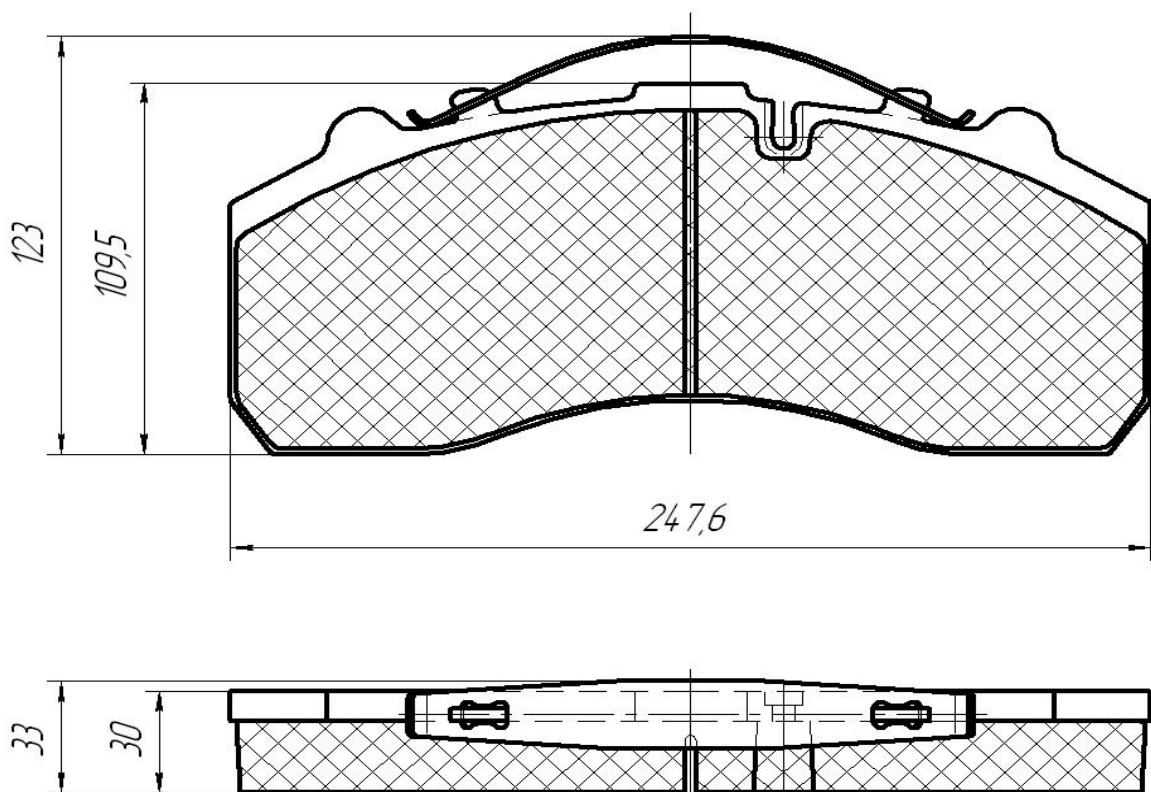

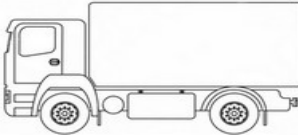
Номер для за-каза	Количество изделий в комплекте			
ТР.А-115	4 одинаковых изделия	BOVA	•	•
		D.A.F.	•	•
		DENNIS	•	•
		IVECO	•	•
		MAN	•	•
		MERCEDES-BENZ	•	•
		NEOPLAN	•	•
		RENAULT TRUCKS	•	•
		SCANIA	•	•
		SETRA	•	•
		SOLARIS	•	•
		КАМАЗ	•	•
		ЛИАЗ	•	

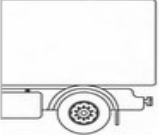

Номер для заказа	Количество изделий в комплекте			
ТР.А-121		BPW		•
		MERCEDES-BENZ	•	•
		SAF		•

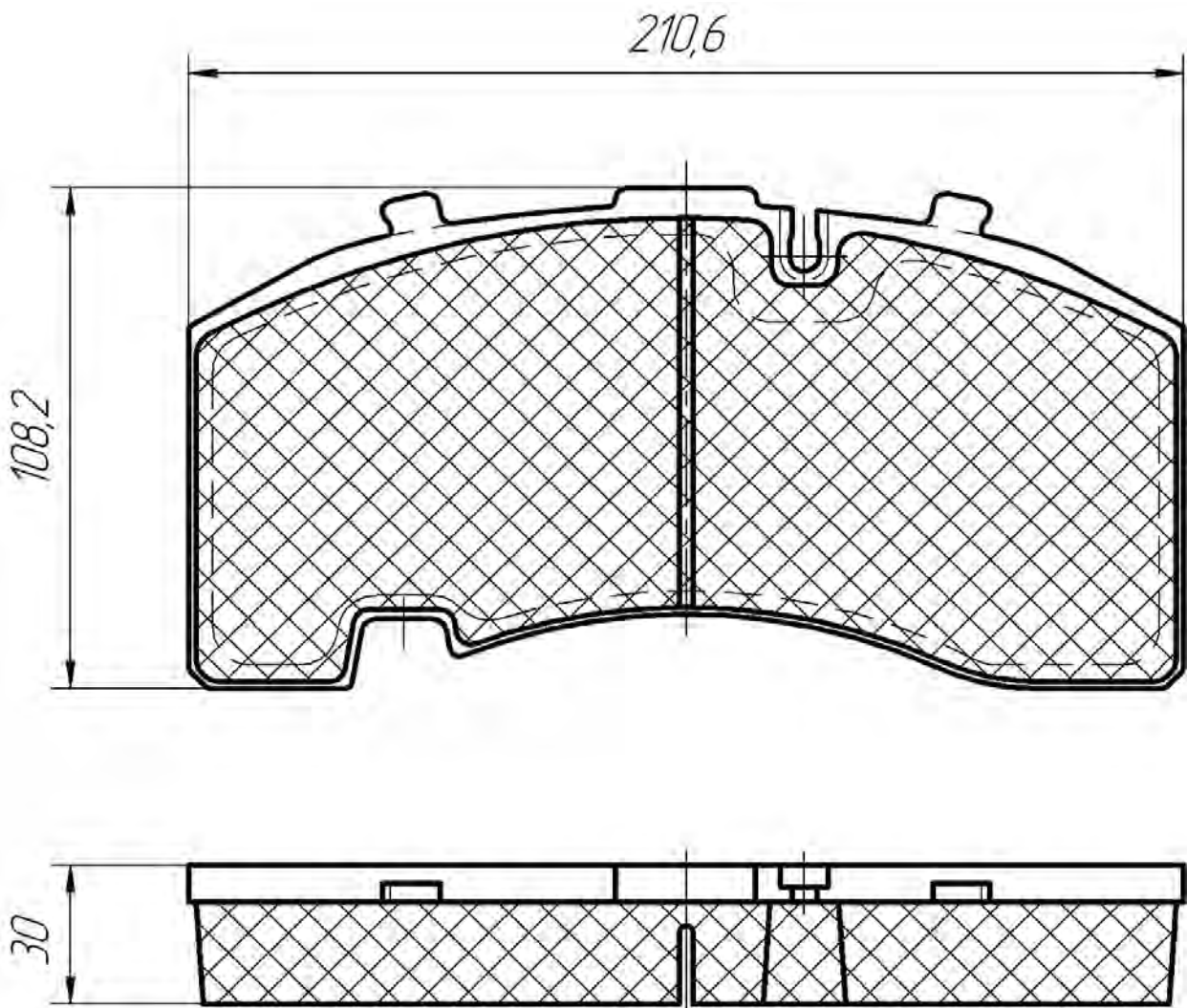

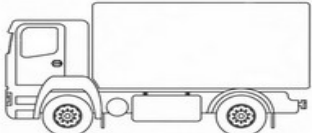
4 одинаковых изделия

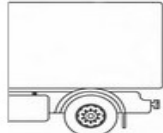

Номер для заказа	Количество изделий в комплекте			
ТР.А-122	BPW		•	
	MAN	•	•	
	ЛИАЗ	•		

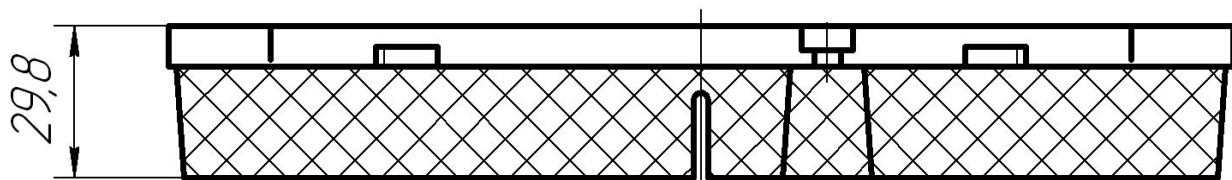
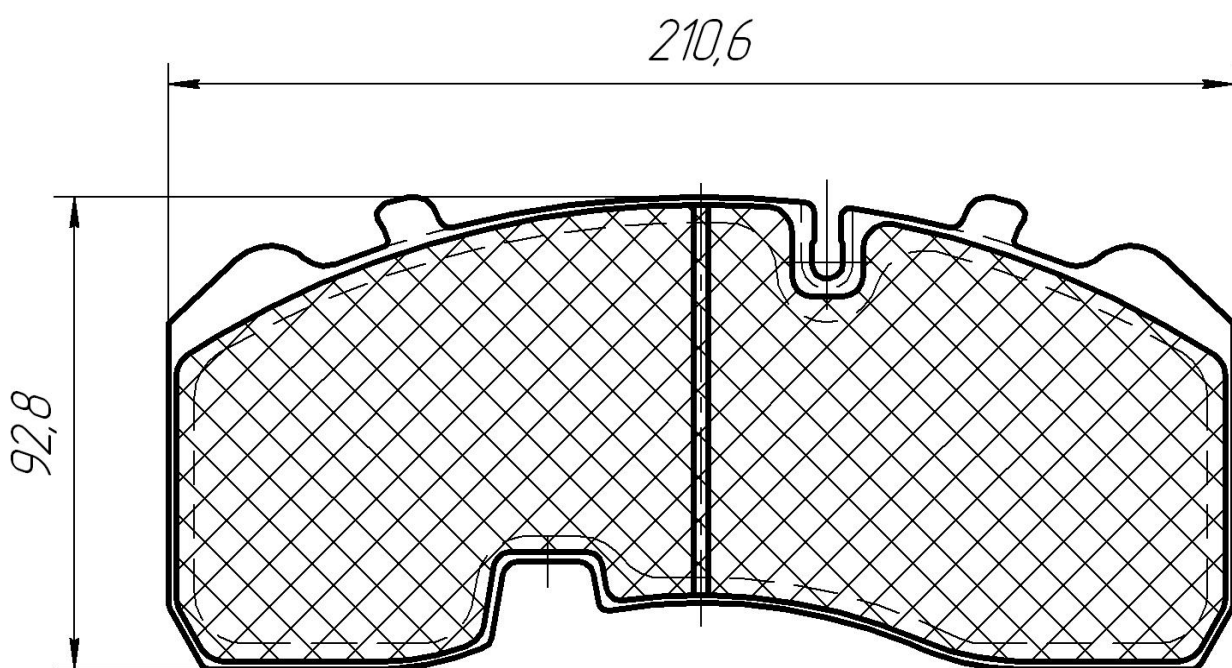

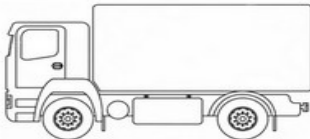
4 одинаковых изделия

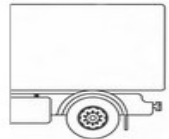

Номер для за-каза	Количество изделий в комплекте			
<div data-bbox="212 371 526 472" style="border: 1px solid black; padding: 5px; text-align: center;"> ТР.А-123 </div>		GIGANT PROTEC		•
		SAF		•

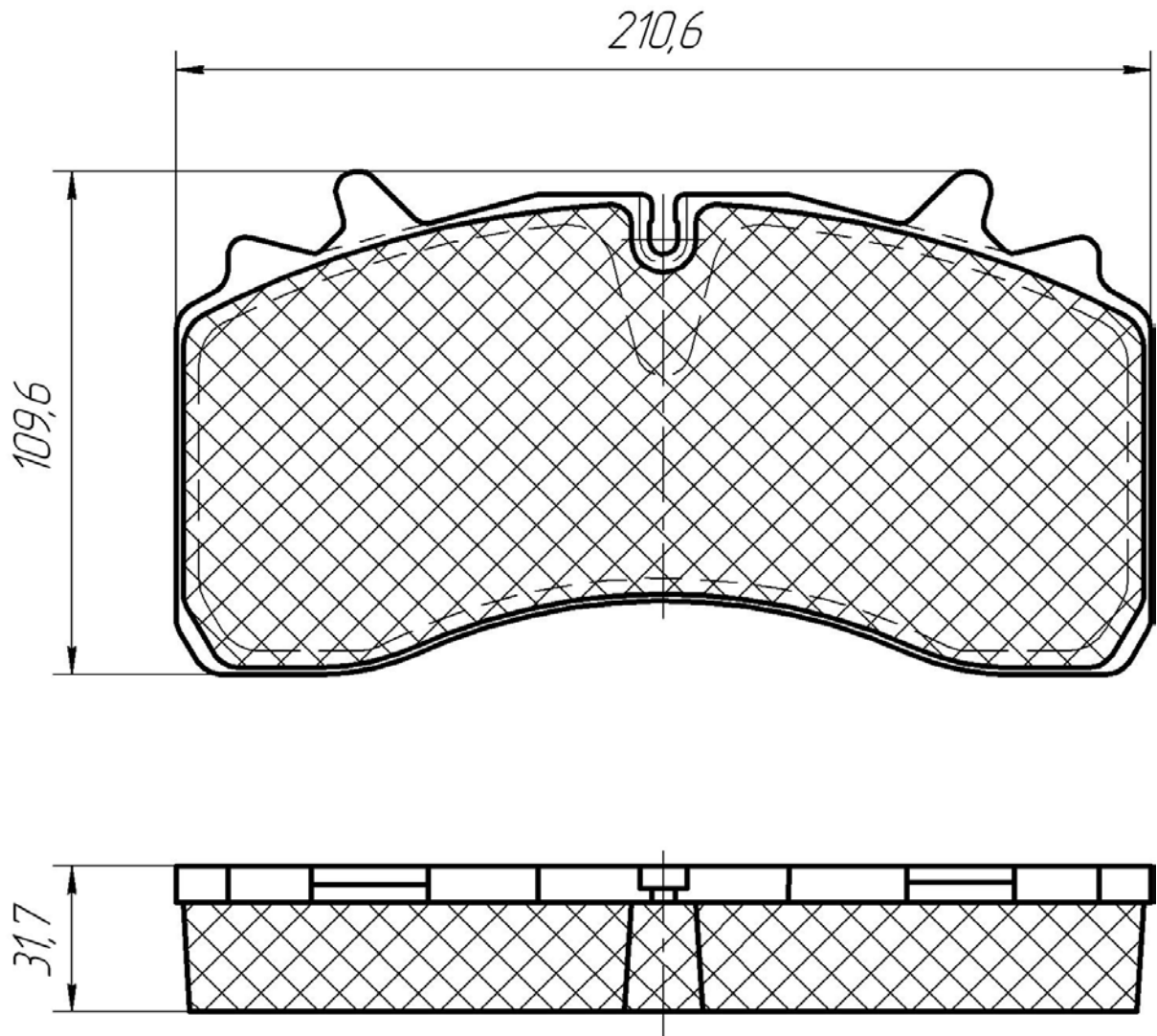
4 одинаковых изделия

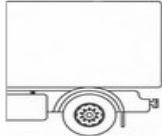

Номер для заказа	Количество изделий в комплекте			
ТР.А-124	D.A.F.	•		
	DENNIS	•	•	
	SAF	•	•	
	MAZ	•		

4 одинаковых изделия

